

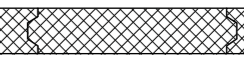



- LEGENDA E NOTE -

-  SETTI STRUTTURALI Quota piano finito p.p.f.
-  PARATIE Quota rustico
-  AREA DI PROGETTO
-  GRIGLIE SU COMPARTIMENTI REI 180 AEC19/002a
-  AeTab001a Riferimento alla tavola di dettaglio

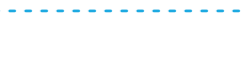

Sezione AA, scala 1:100

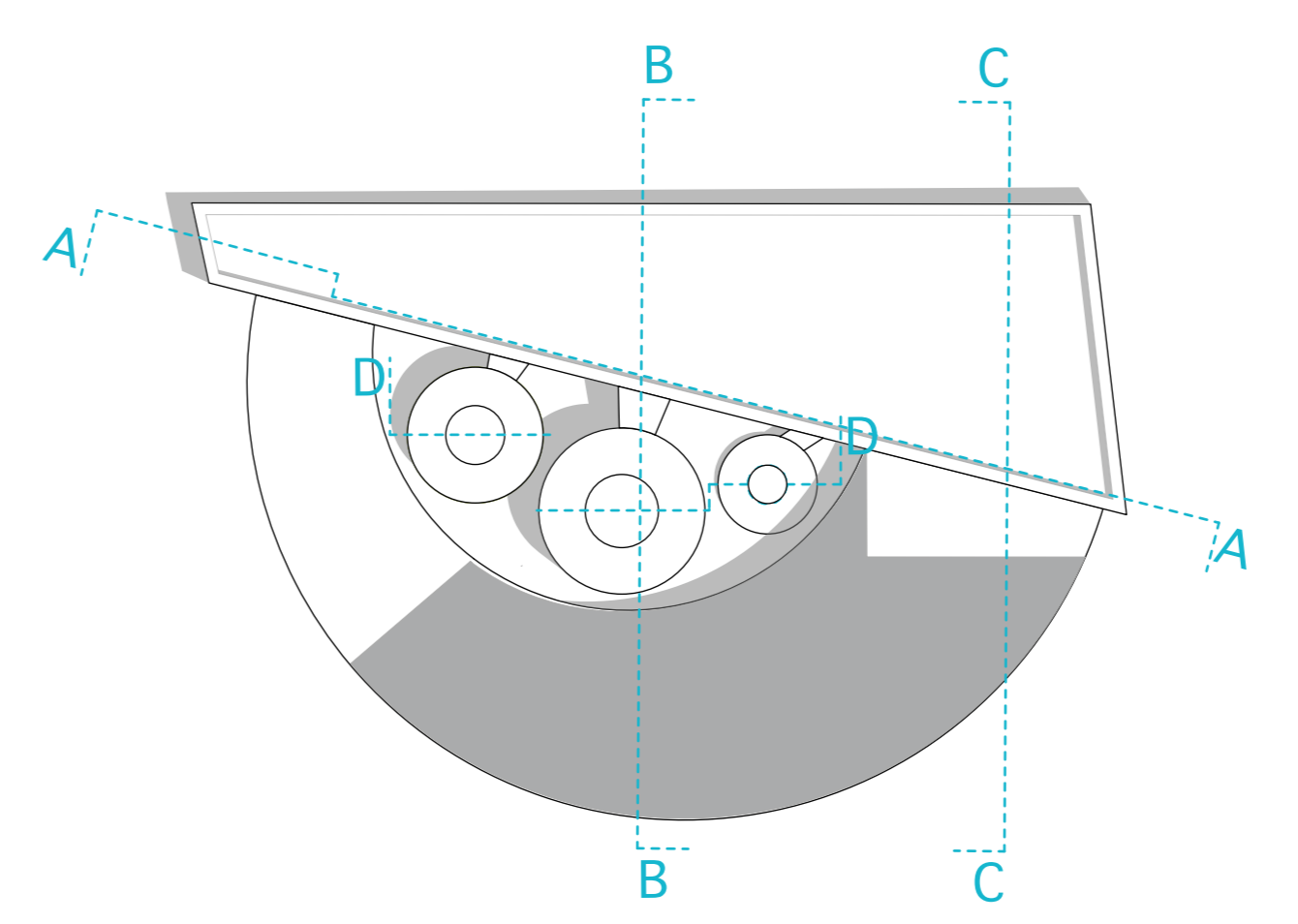
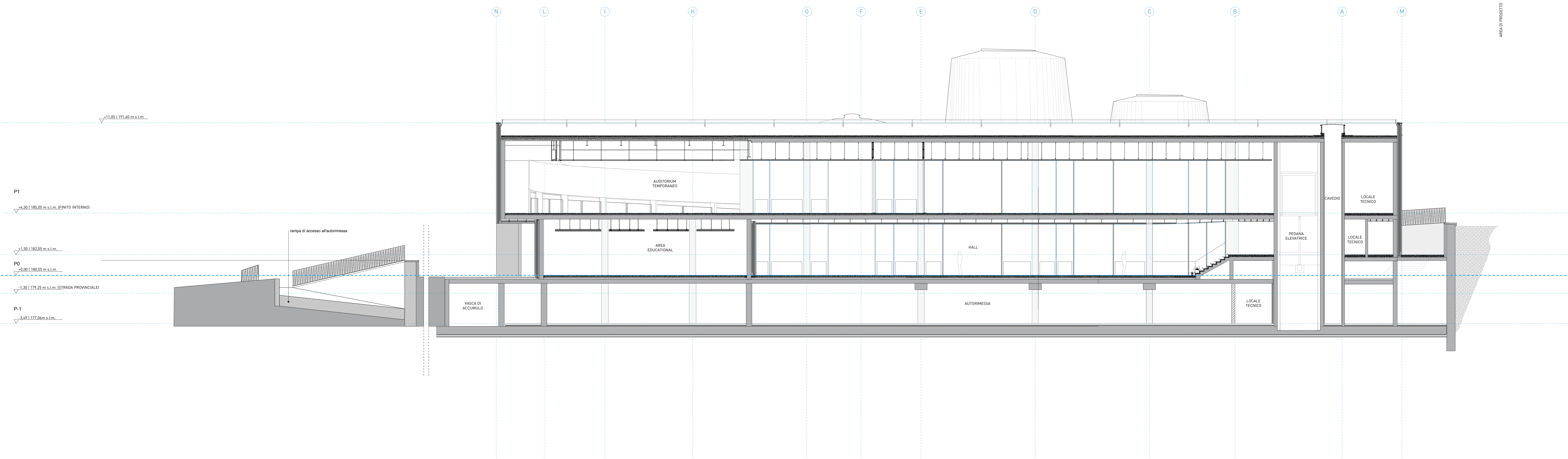

SEZIONE CC, scala 1:100

