

Proyecto  
Espacio Promocional Endutex  
CPrint!

Ciente:  
Endutex Ibérica

Locación  
Madrid

Fecha  
Agosto 2014

Exp.No.  
2189

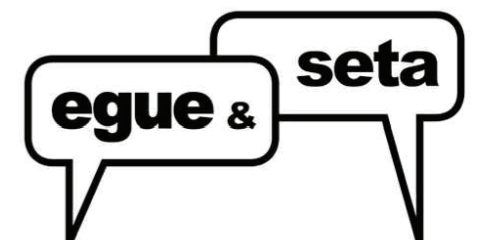

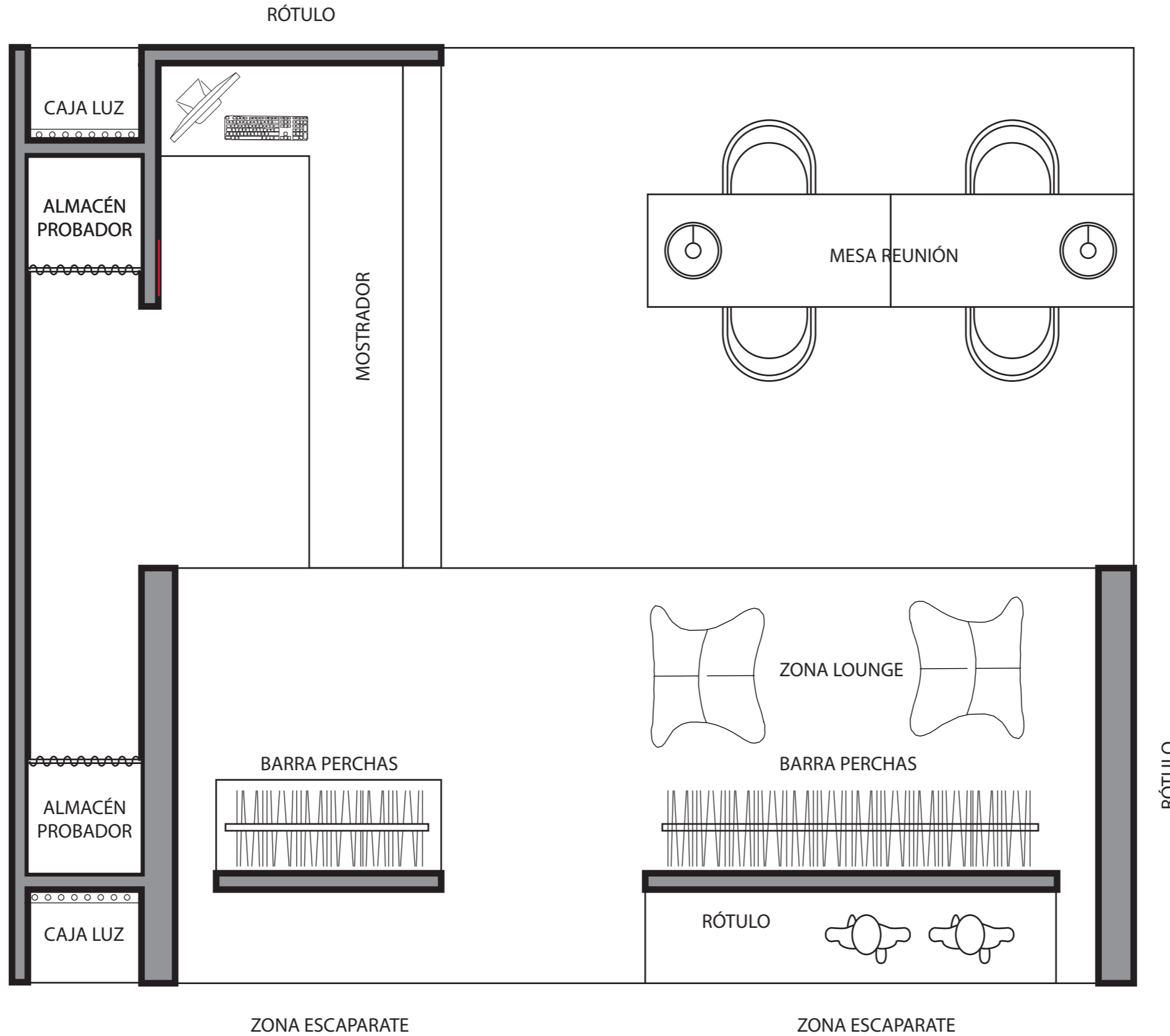

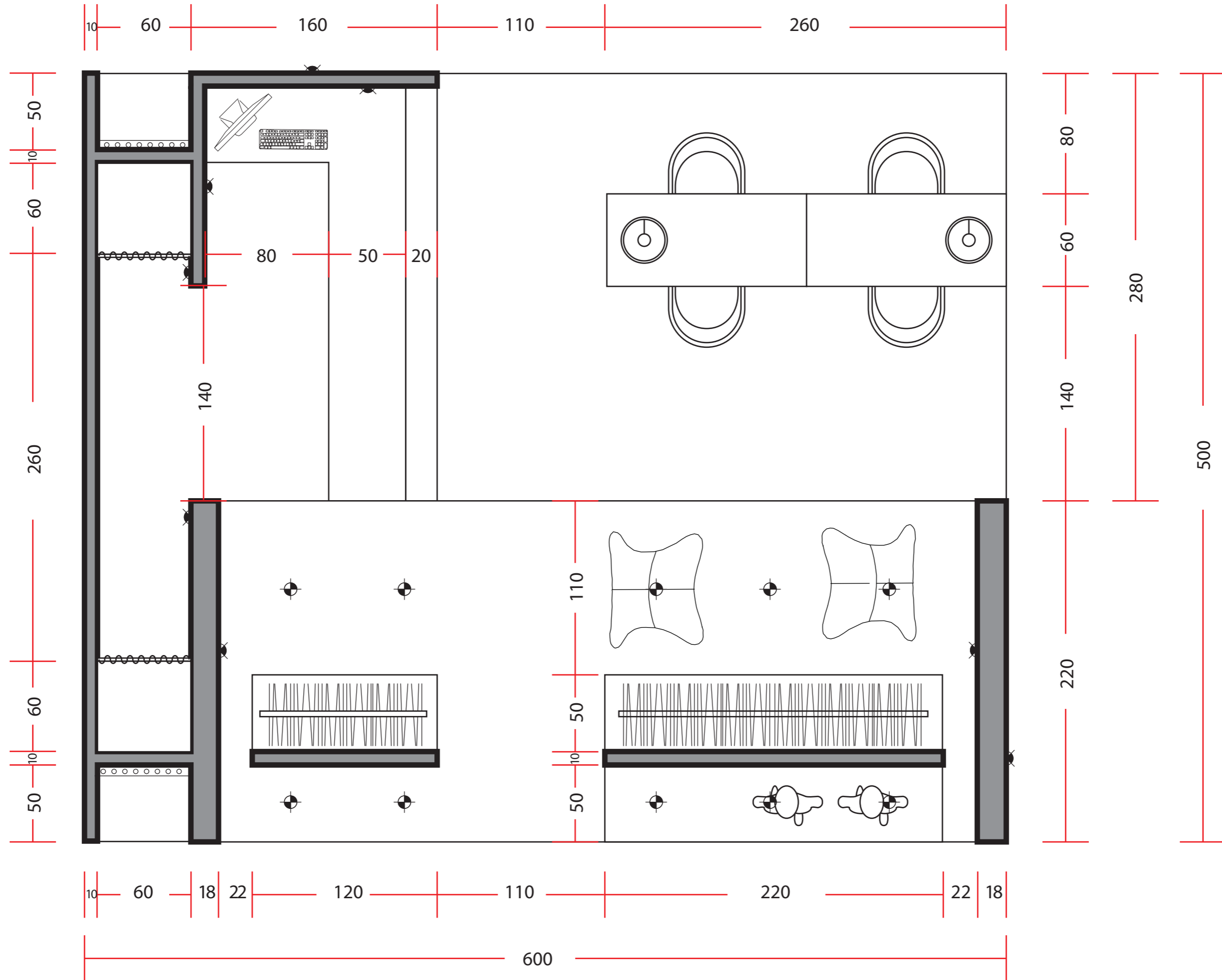

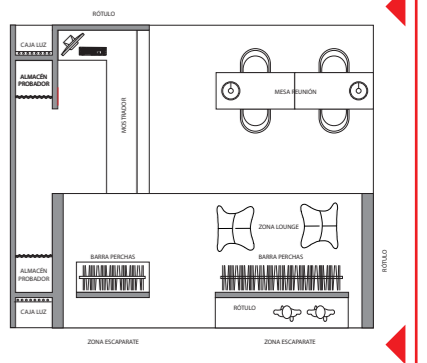
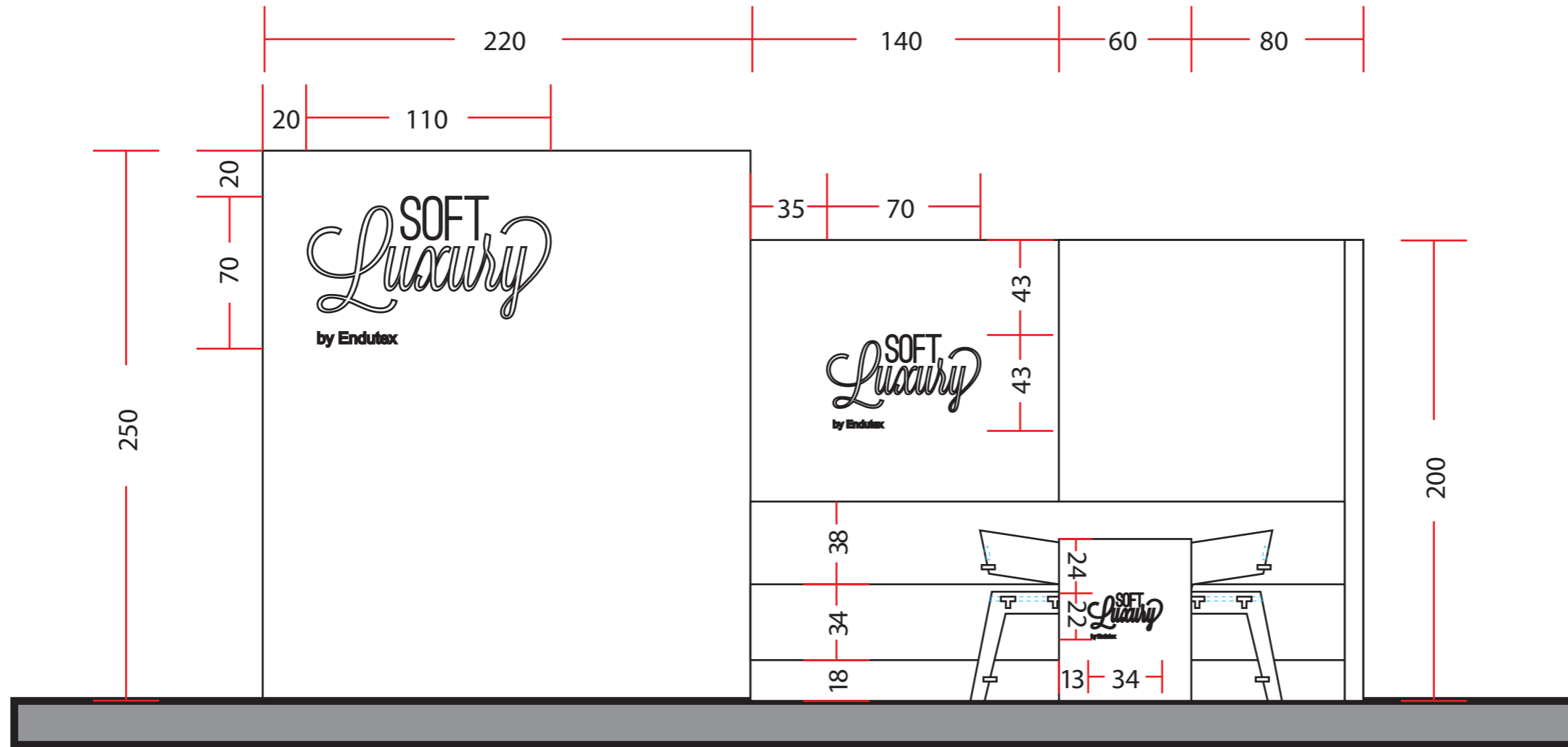

Proyecto  
Espacio Promocional Endutex  
CPrint!  
Cliente:  
Endutex Ibérica

Locación  
Madrid

Fecha  
Agosto 2014

Exp.No. Fase  
2189 Proyecto

Escala Unidades Area  
1:20 Cm 78 m2

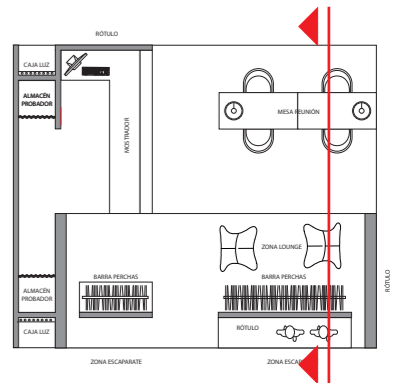
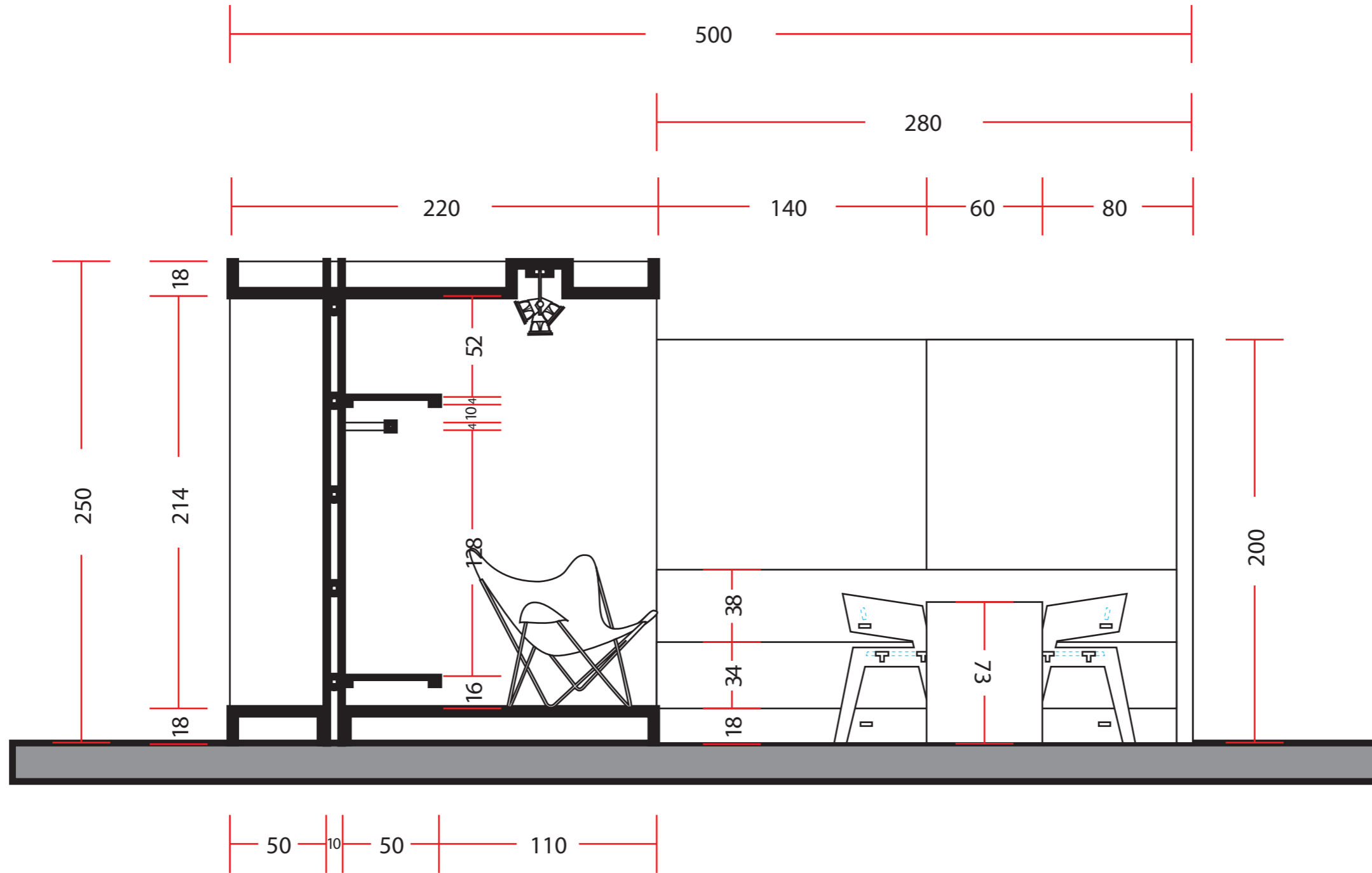

Contenido  
SECCIÓN COTAS

Plano No.

004



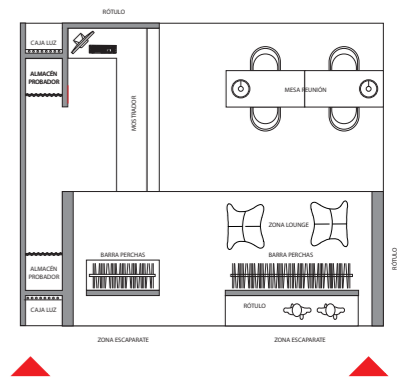
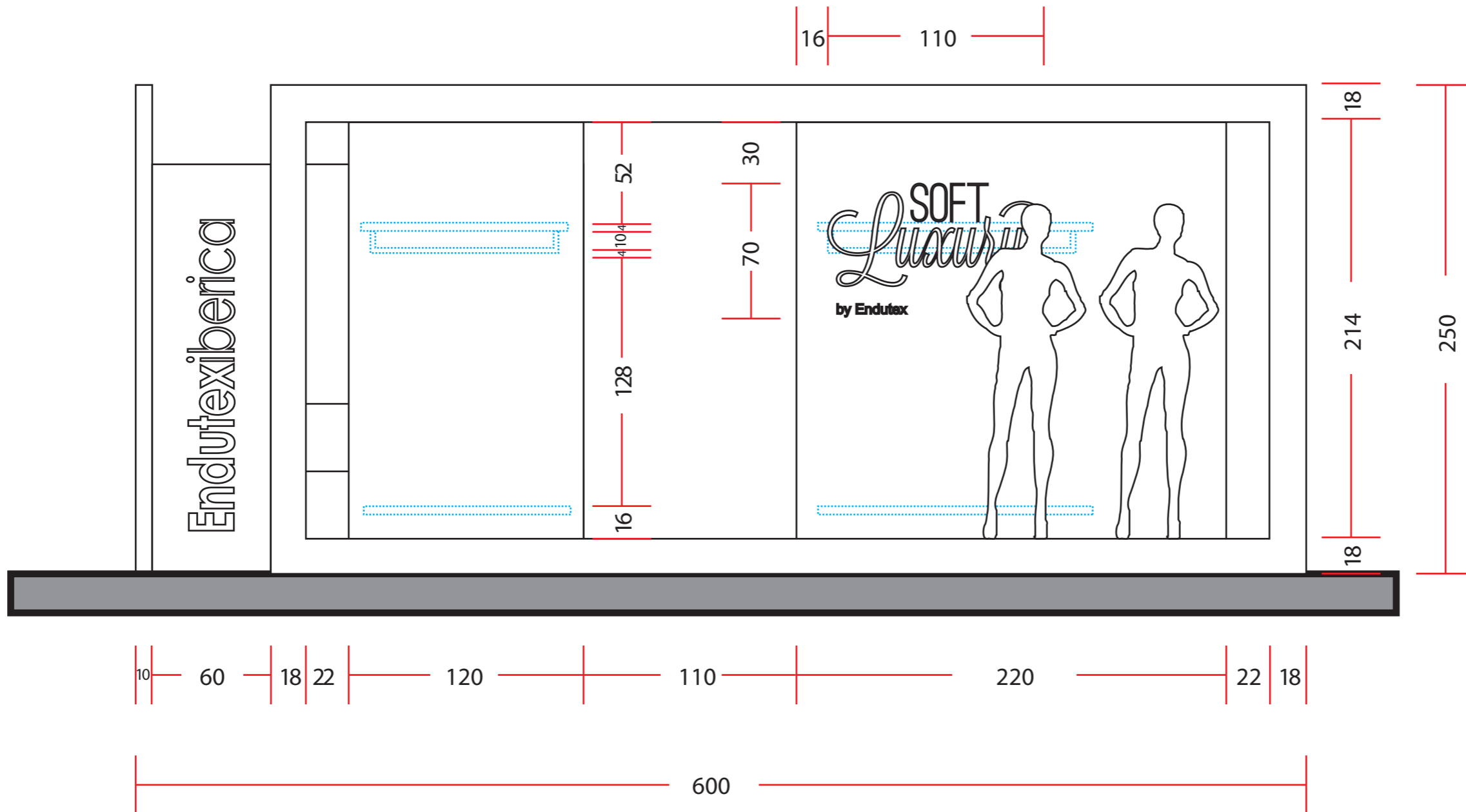

Proyecto  
Espacio Promocional Endutex  
CPrint!  
Cliente:  
Endutex Ibérica

Locación  
Madrid

Fecha  
Agosto 2014

Exp.No. Fase  
2189 Proyecto

Escala Unidades Area  
1:20 Cm 78 m2

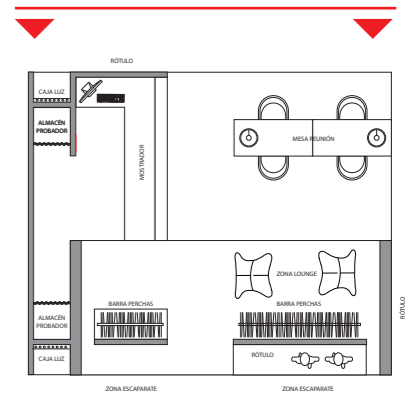
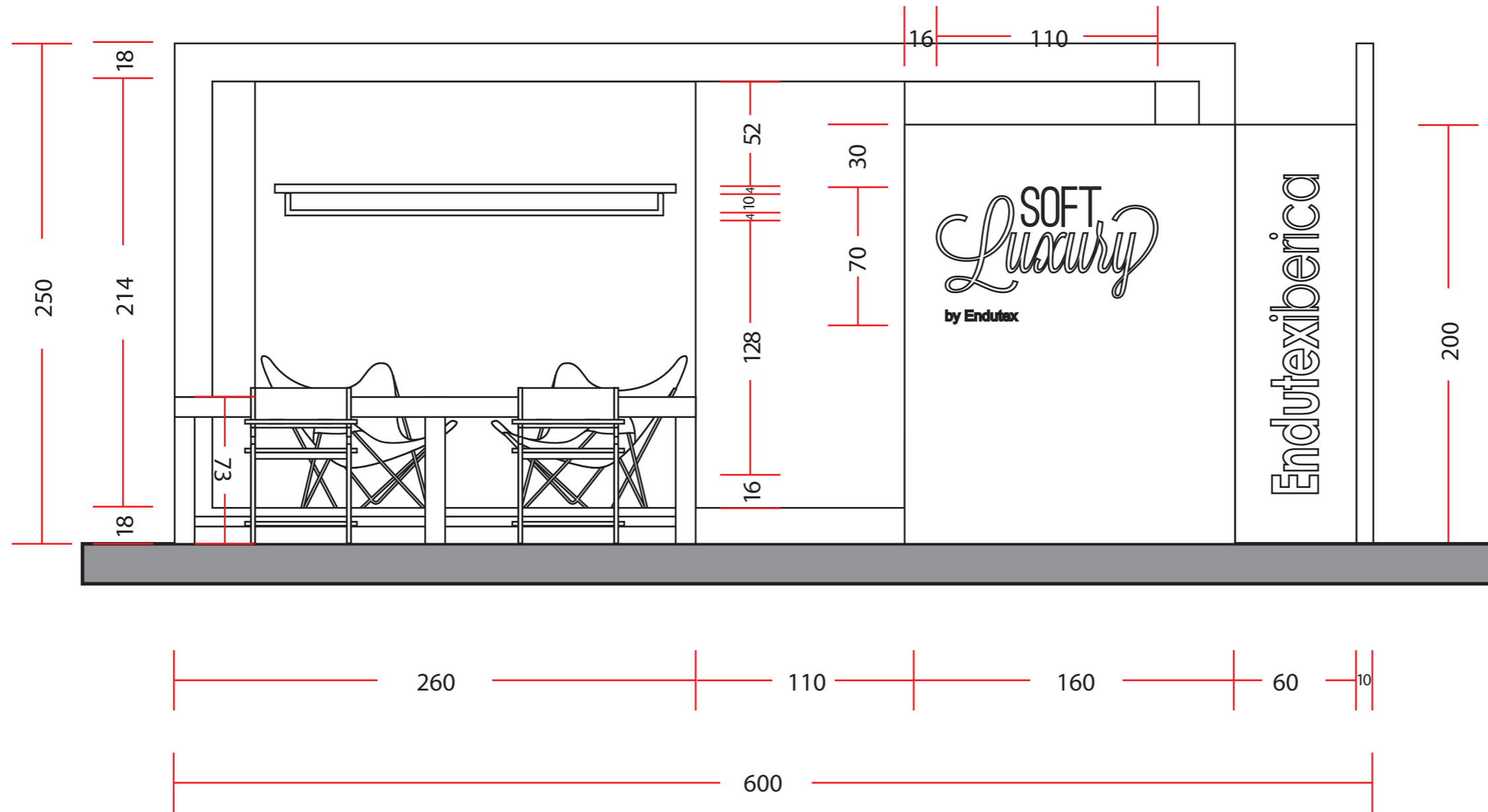

Contenido  
ALZADO COTAS

Plano No.

006



Proyecto  
Espacio Promocional Endutex  
CPrint!  
Cliente:  
Endutex Ibérica

Locación  
Madrid

Fecha  
Agosto 2014

Exp.No. Fase  
2189 Proyecto

Escala Unidades Area  
1:20 Cm 78 m2

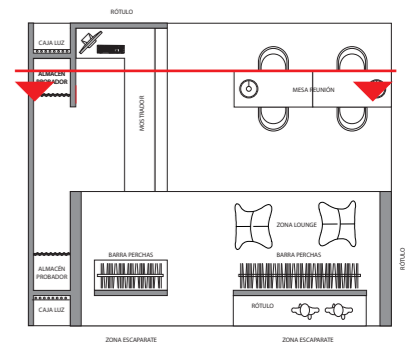
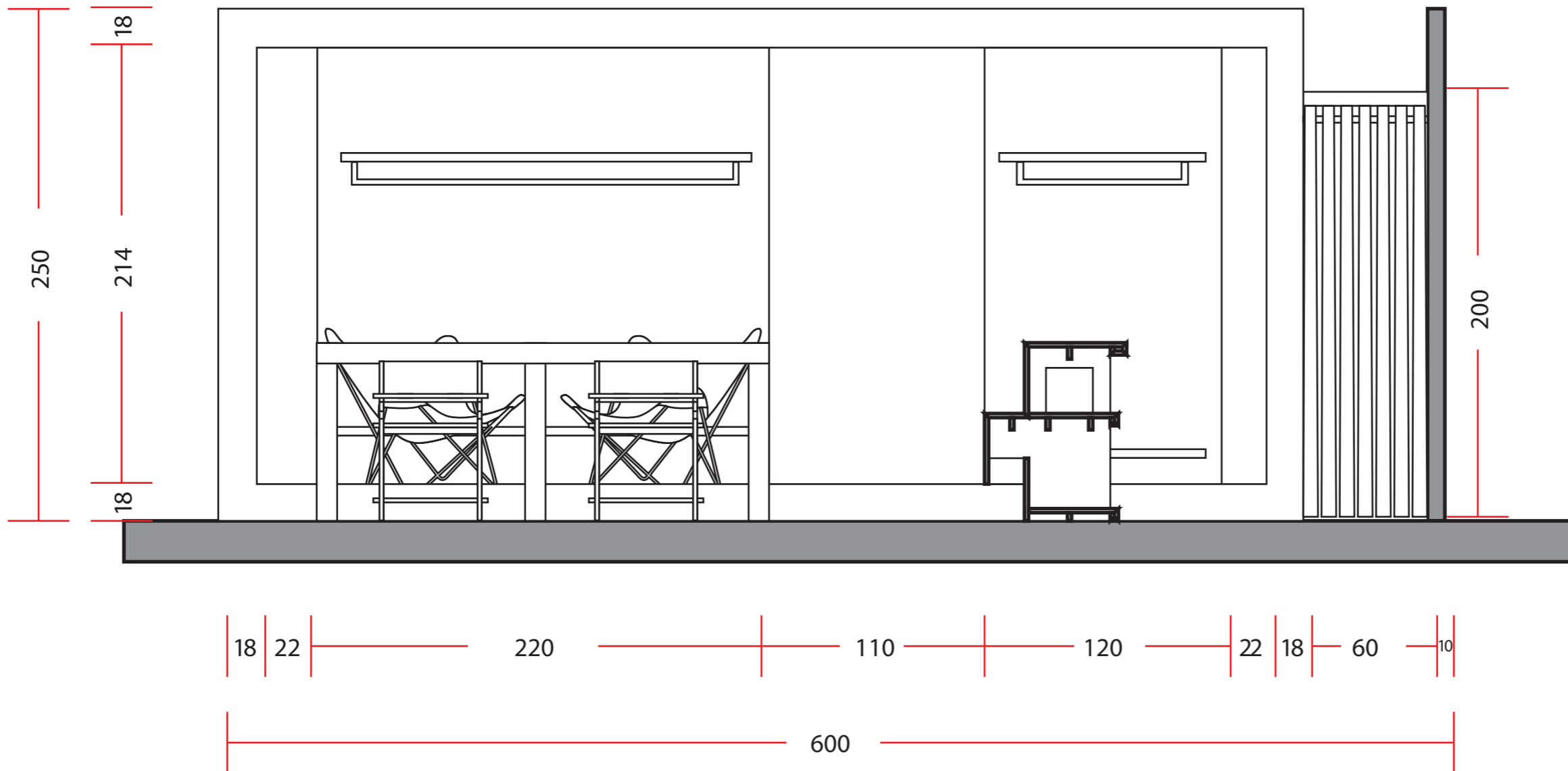

Contenido  
SECCIÓN COTAS

Plano No.

007





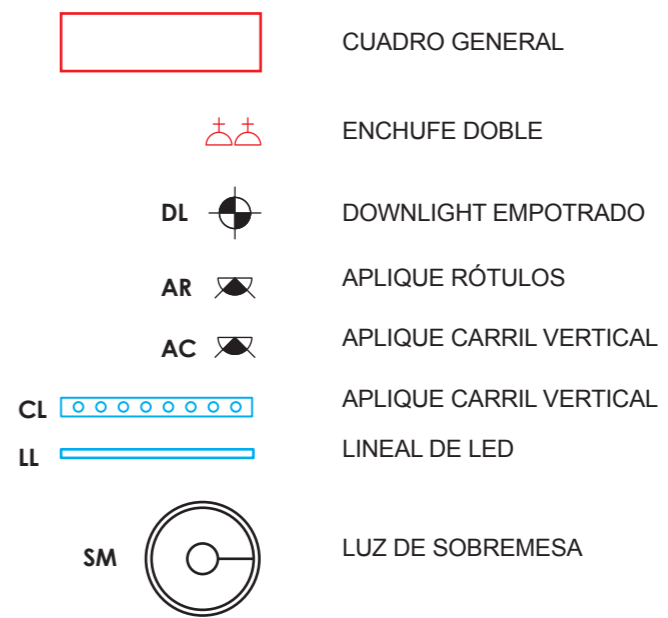
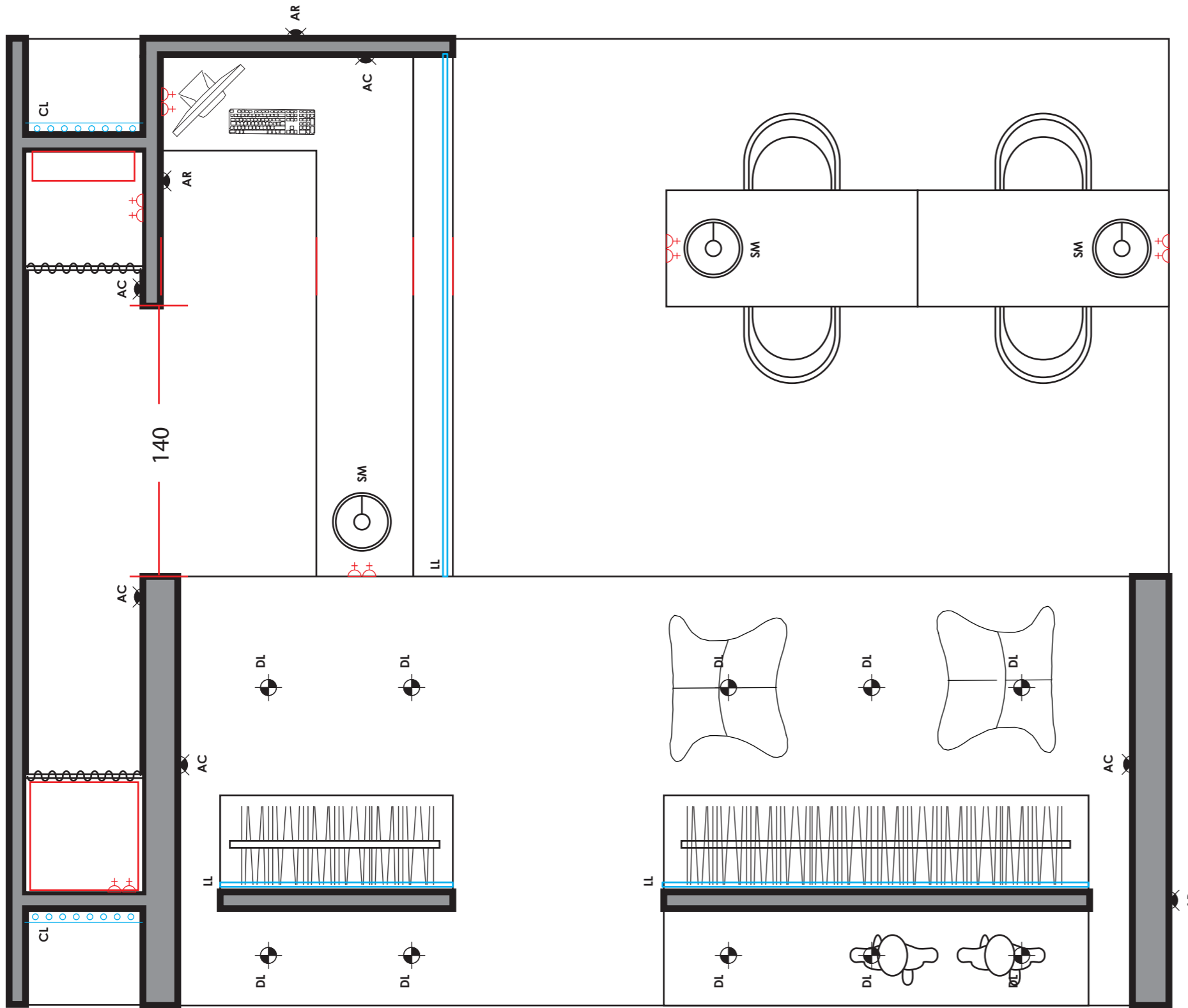

SILLAS REUNIÓN 4 UDS.

Respaldo, posabrazos y patas en PANEL DE ABEJA 30MM (2 planchas 300x160cm) impreso y canteado  
 Asiento y refuerzos horizontales AVIPLEX 9,3MM (2 planchas 240x165cm) impreso y canteado  
 Ancho total: 56 cm / Ancho asiento: 44cm / Prof: 60cm / altura total: 77cm / Altura asiento: 47cm

890x1080mm  
 Aviplex 9,3mm

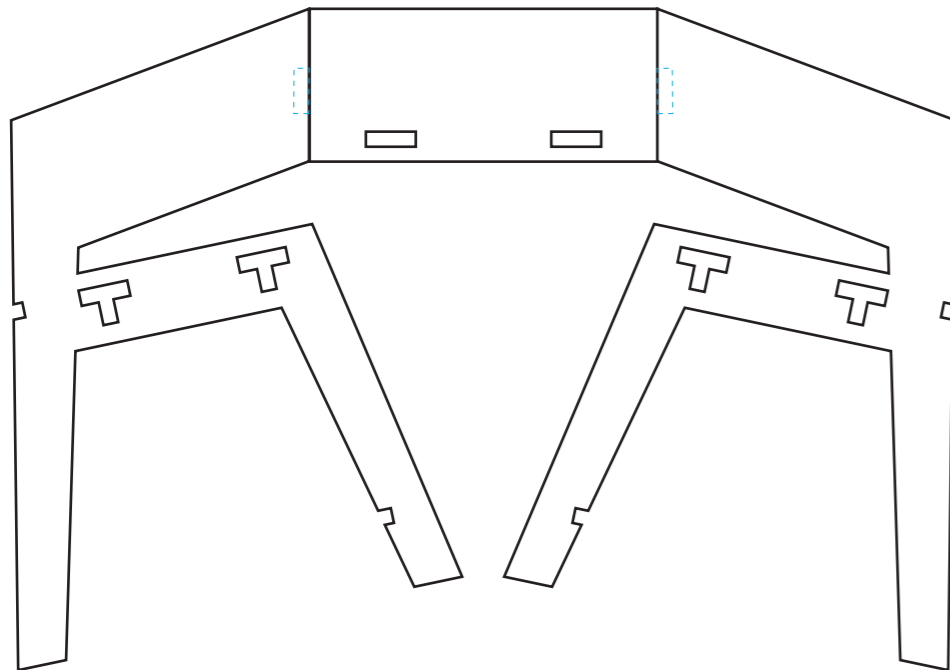
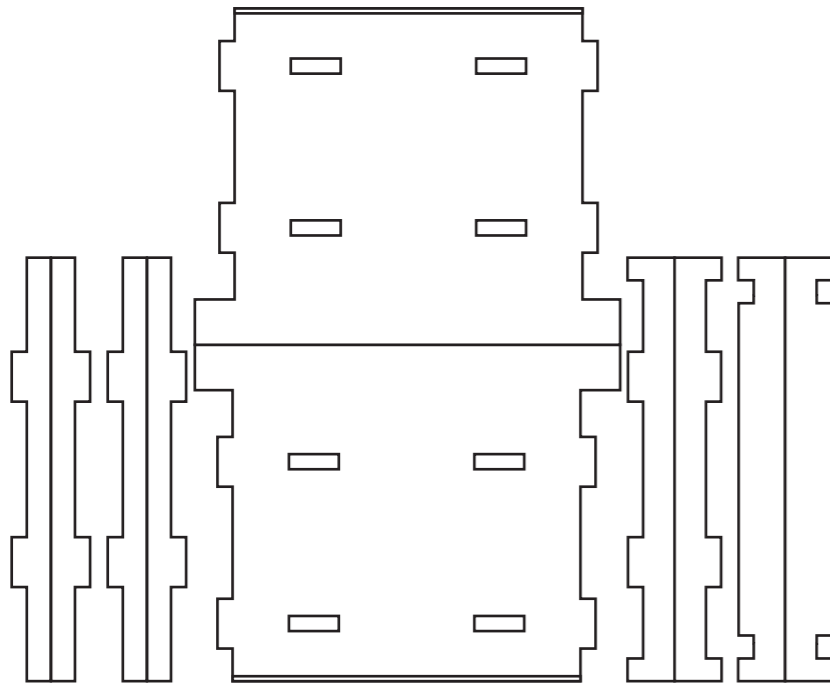

870x1240mm  
 Panel de abeja 30mm

VISTA LATERAL  
 ENSAMBLADO

Ancho total: 56 cm  
 Ancho asiento: 44cm  
 Prof: 60cm  
 altura total: 77cm  
 Altura asiento:

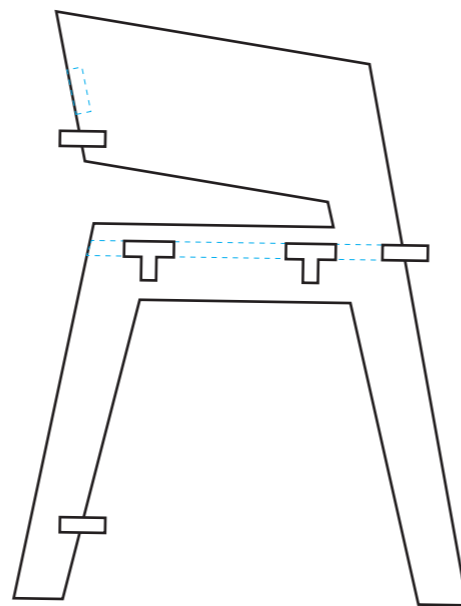

VISTA FRONTAL  
 ENSAMBLADO

Ancho total: 56 cm  
 Ancho asiento: 44cm  
 Prof: 60cm  
 altura total: 77cm  
 Altura asiento:

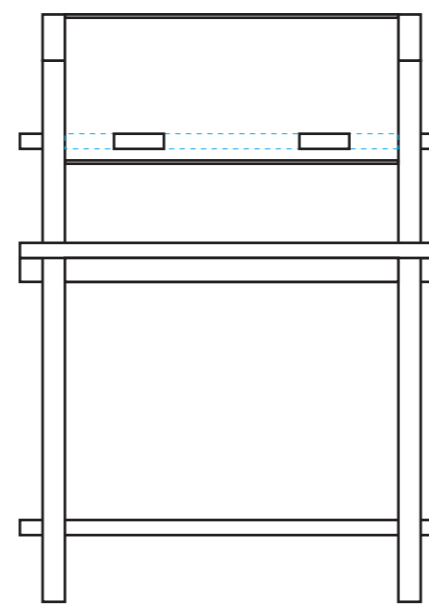

VISTA TRASERA  
 ENSAMBLADO

Ancho total: 56 cm  
 Ancho asiento: 44cm  
 Prof: 60cm  
 altura total: 77cm  
 Altura asiento:

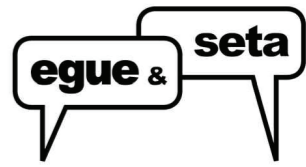
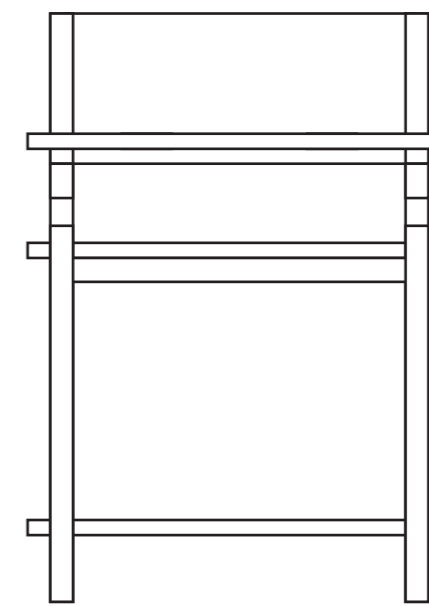

c/Casp 54 1ª B - 08010 Barcelona +34 931 791 992  
 e-mail: info@egueyseta.com

Proyecto  
 Espacio Promocional Endutex  
 CPrint!  
 Cliente:  
 Endutex Ibérica

Locación  
 Madrid

Fecha  
 Agosto 2014

Exp.No. Fase  
 2189 Proyecto

Escala Unidades Area  
 1:20 Cm 78 m2

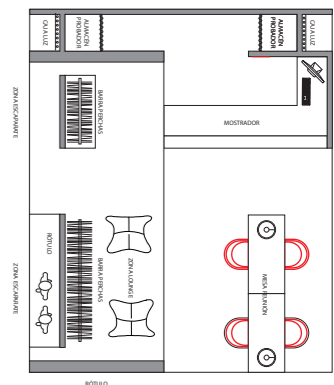

Contenido  
 DETALLE MOBILIARIO

Plano No.

009



# MESA REUNIÓN 4 UDS. (PATAS)

Asiento y refuerzos horizontales AVIPLEX 9,3MM (2 planchas 240x165cm) impreso  
Ancho total PLEGADO: 60 cm / Prof: 6cm / altura total: 72cm

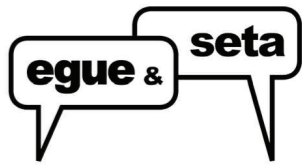

c/Casp 54 1ª B - 08010 Barcelona +34 931 791 992  
e-mail: info@egueyseta.com

Proyecto  
Espacio Promocional Endutex  
CPrint!  
Cliente:  
Endutex Ibérica

Locación  
Madrid

Fecha  
Agosto 2014

Exp.No. Fase  
2189 Proyecto

Escala Unidades Area  
1:20 Cm 78 m2

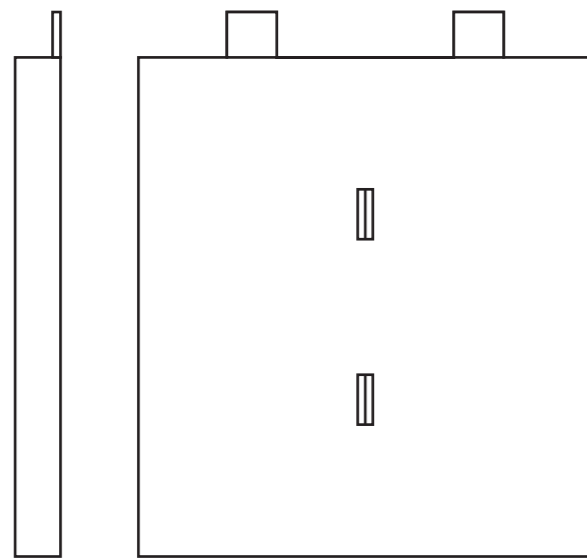

VISTA LATERAL

VISTA FRONTAL



PLANTA

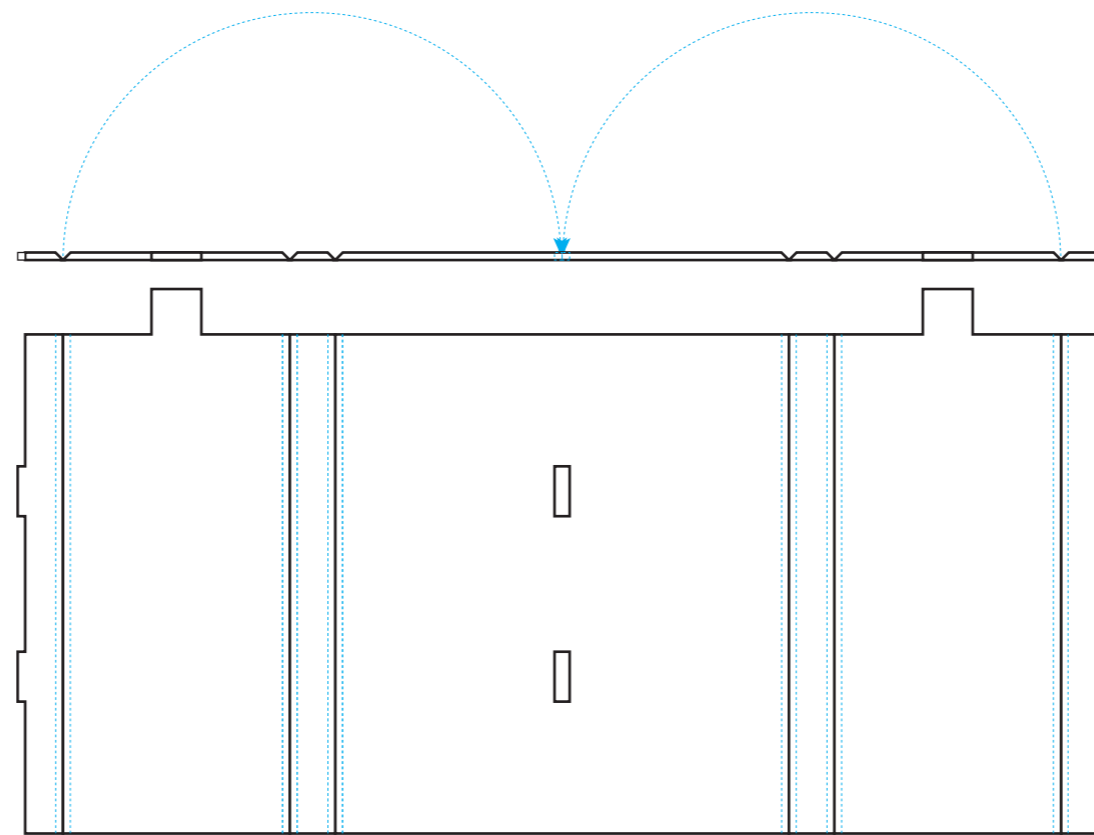

1430x720mm  
Aviplex 9,3mm

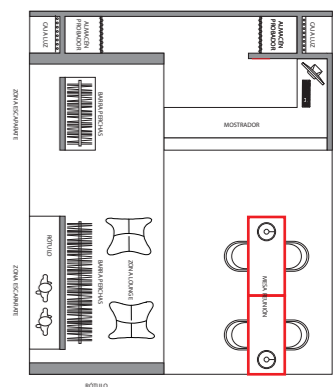

Contenido  
DETALLE MOBILIARIO

Plano No.

010



# MESA ENCIMERAS 2 UDS. (PATAS)

AVIPLEX 9,3MM (2 planchas 240x165cm) crudo (sin impresión)  
Ancho total PLEGADO: 129 cm / Prof: 60cm / altura total: 6cm



c/Casp 54 1ª B - 08010 Barcelona +34 931 791 992  
e-mail: info@egueyseta.com

Proyecto  
Espacio Promocional Endutex  
CPrint!  
Cliente:  
Endutex Ibérica

Locación  
Madrid

Fecha  
Agosto 2014

Exp.No. Fase  
2189 Proyecto

Escala Unidades Area  
1:20 Cm 78 m2

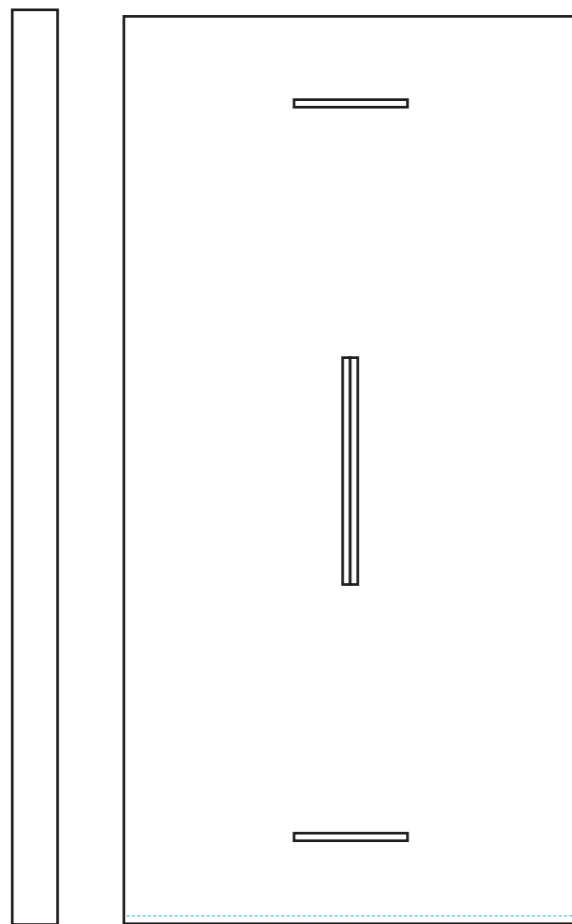

VISTA LATERAL

PLANTA



VISTA FRONTAL

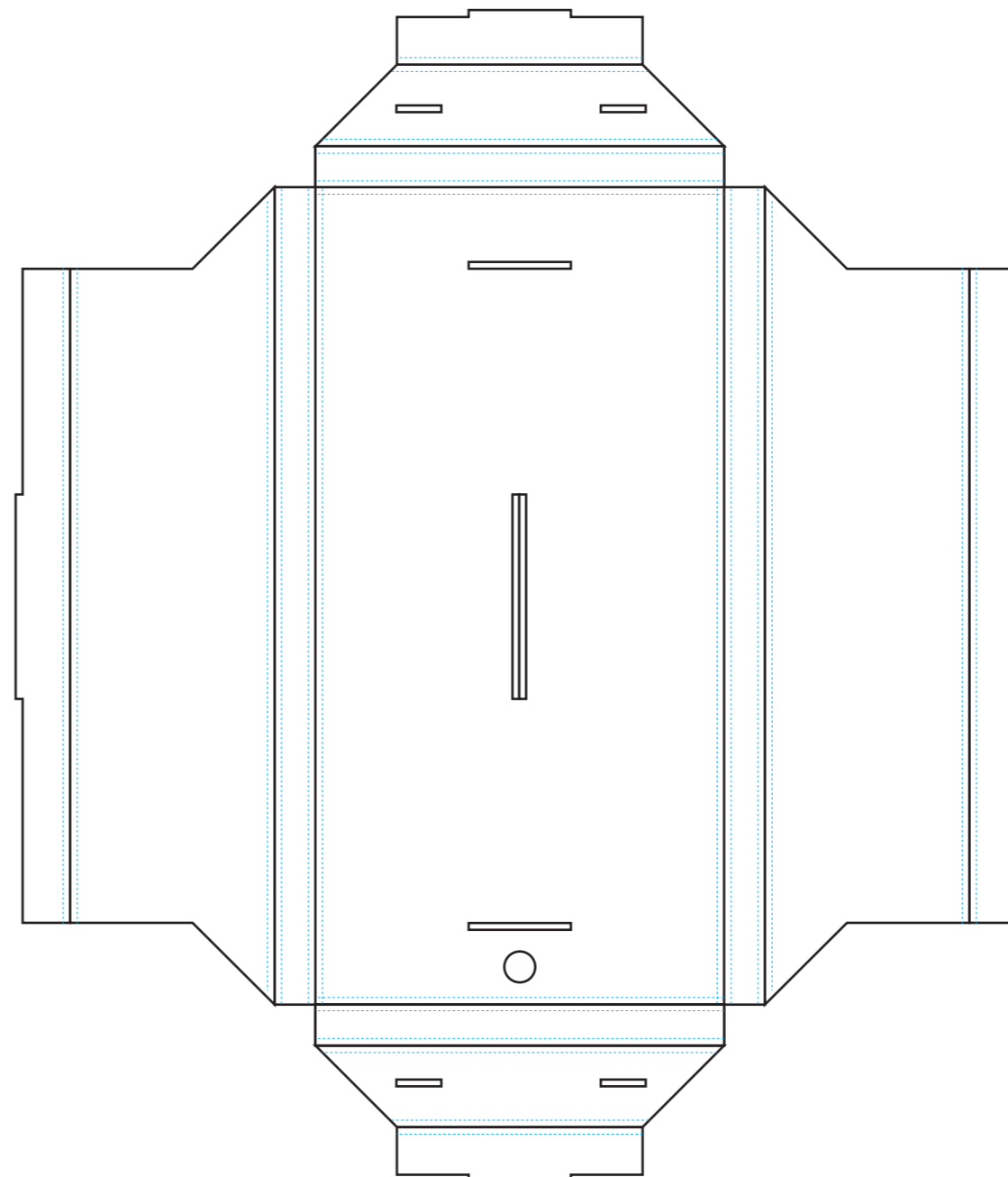

1480x1720mm  
Aviplex 9,3mm

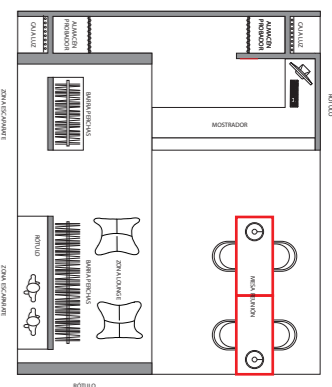

Contenido  
DETALLE MOBILIARIO

Plano No.

011



ESTANTES EXPOSICIÓN 2 UDS. (extremo derecho)

AVIPLEX 9,3MM (2 planchas 240x165cm) impreso  
 Ancho total PLEGADO: 100 cm / Prof: 50cm / altura total: 4cm



c/Casp 54 1ª B - 08010 Barcelona +34 931 791 992  
 e-mail: info@egueyseta.com

Proyecto  
 Espacio Promocional Endutex  
 CPrint!  
 Cliente:  
 Endutex Ibérica

Locación  
 Madrid

Fecha  
 Agosto 2014

Exp.No. Fase  
 2189 Proyecto

Escala Unidades Area  
 1:20 Cm 78 m2

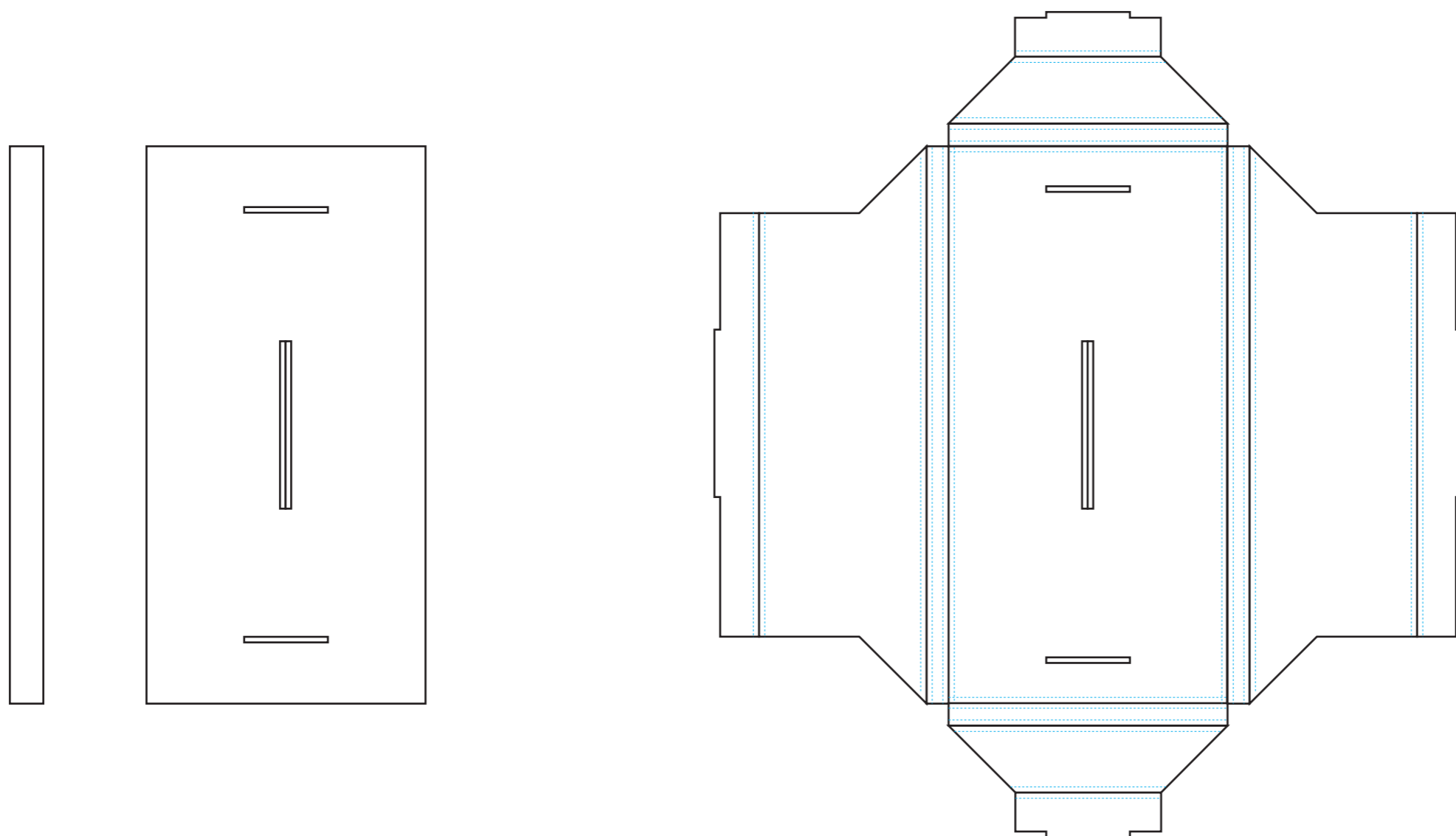

VISTA LATERAL PLANTA

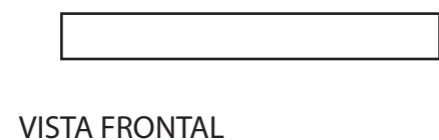

VISTA FRONTAL

1480x1340mm  
 Aviplex 9,3mm

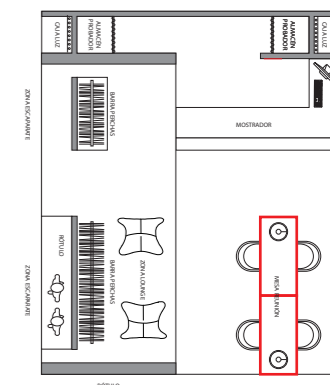

Contenido  
 DETALLE MOBILIARIO

Plano No.

012



ESTANTES EXPOSICIÓN 2 UDS. (extremo izquierdo)

AVIPLEX 9,3MM (2 planchas 240x165cm) impreso  
 Ancho total PLEGADO: 190cm / Prof: 50cm / altura total: 4cm

Proyecto  
 Espacio Promocional Endutex  
 CPrint!  
 Cliente:  
 Endutex Ibérica

Locación  
 Madrid

Fecha  
 Agosto 2014

Exp.No. Fase  
 2189 Proyecto

Escala Unidades Area  
 1:20 Cm 78 m2

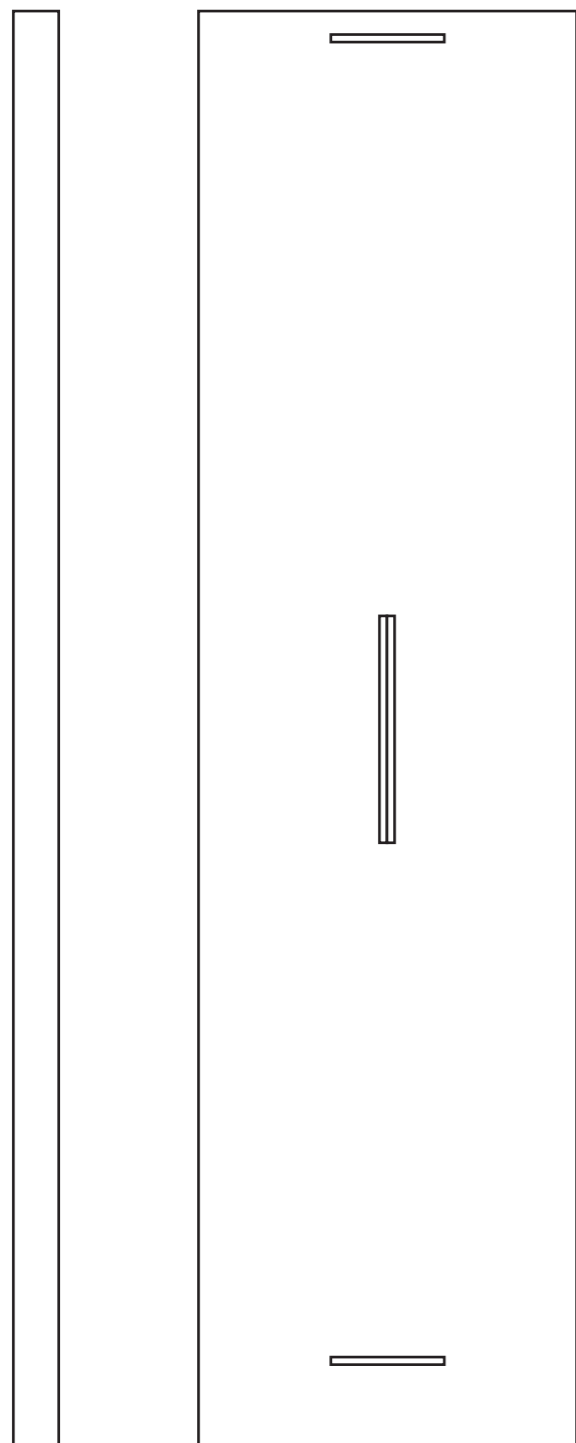

VISTA LATERAL PLANTA

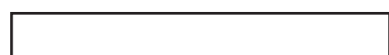

VISTA FRONTAL

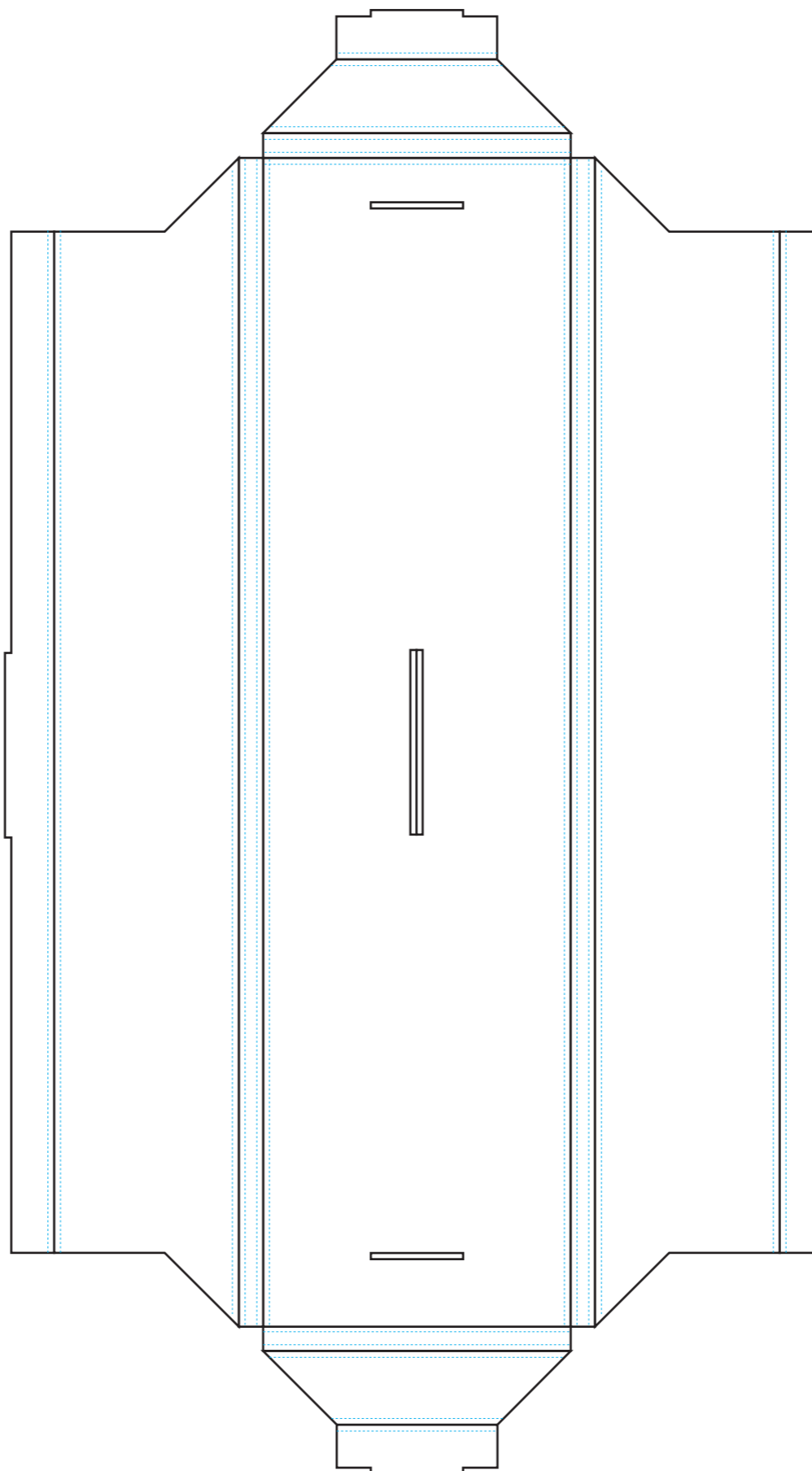

2378x1340mm  
 Aviplex 9,3mm

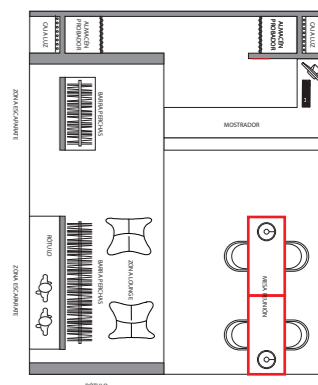

Contenido  
 DETALLE MOBILIARIO

Plano No.

013



MOSTRADOR 1 UDS. (porción frontal)

PANEL DE ABEJA impres0 y canteado: 0,57 ud  
 AVIPLEX 9,3MM (2 planchas 240x165cm) impreso  
 Ancho total MONTADO: 260cm / Prof: 64cm / altura total: 90cm



c/Casp 54 1ª1ªB - 08010 Barcelona +34 931 791 992  
 e-mail: info@egueyseta.com

Proyecto  
 Espacio Promocional Endutex  
 CPrint!  
 Cliente:  
 Endutex Ibérica

Locación  
 Madrid

Fecha  
 Agosto 2014

Exp.No. Fase  
 2189 Proyecto

Escala Unidades Area  
 1:20 Cm 78 m2

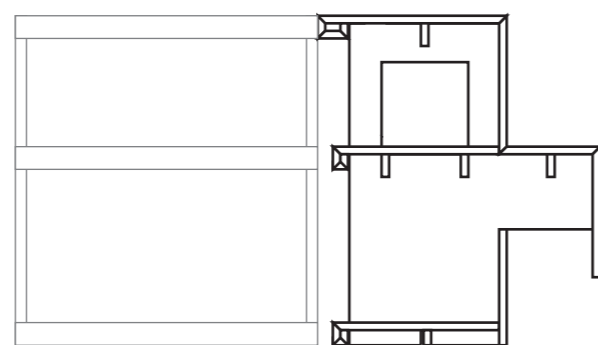

VISTA LATERAL

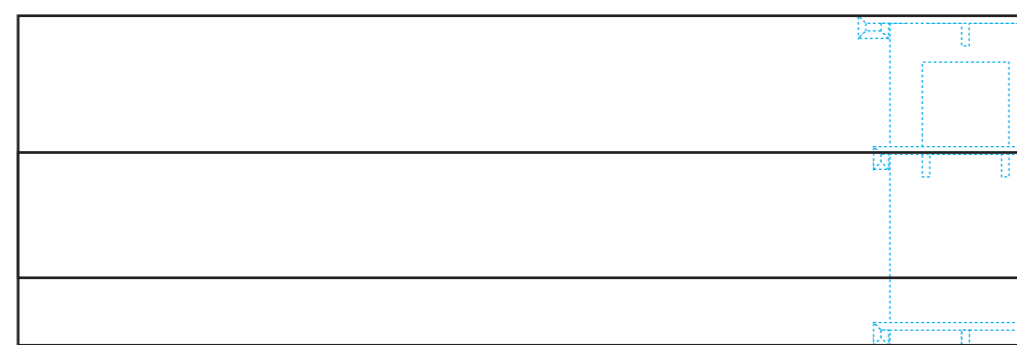

VISTA FRONTAL

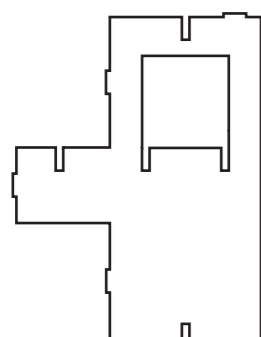

4uds  
 Montantes (72x86cm)  
 Panel de Abeja 30mm  
 TOTAL PLANCHAS: 0,57 ud

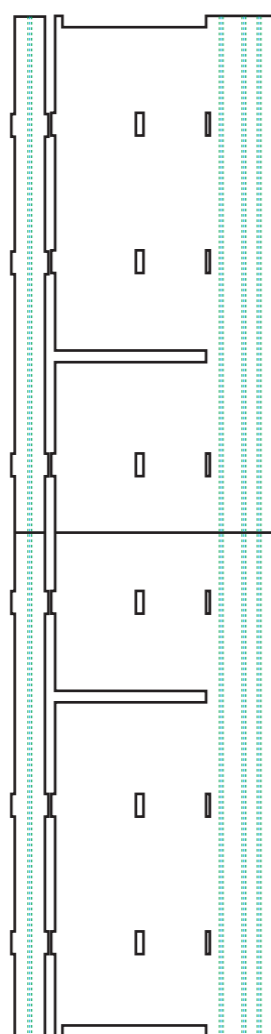

1ud  
 Estante inferior  
 Aviplex 9,3mm

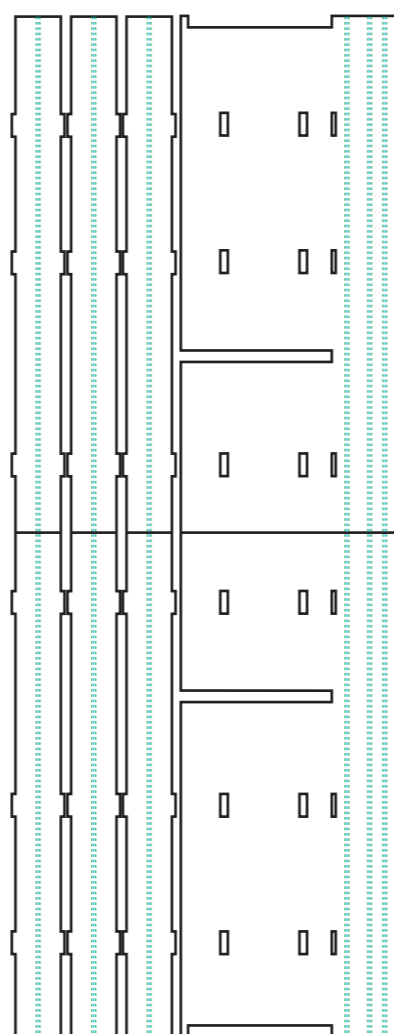

1ud  
 Estante intermedio  
 Aviplex 9,3mm

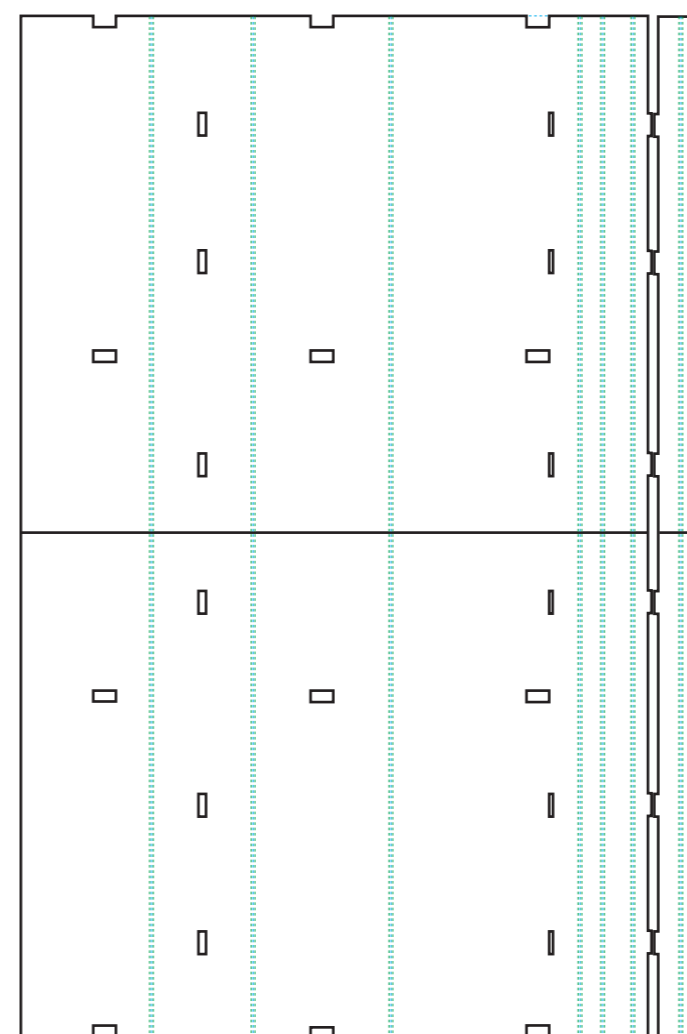

1 ud  
 encimera y frontal  
 Aviplex 9,3mm



1 ud  
 faldón  
 Aviplex 9,3mm

TOTAL: 4 PLANCHAS AVIPLEX (165x240cm)

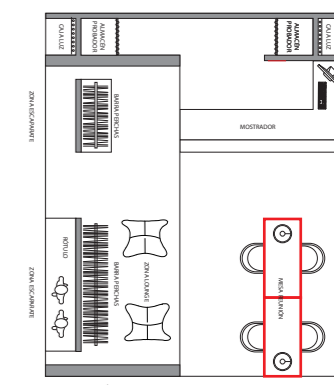

Contenido  
 DETALLE MOBILIARIO

Plano No.

014



MOSTRADOR 1 UDS. (porción frontal)

PANEL DE ABEJA impreso y canteado: 0,28 ud  
 AVIPLEX 9,3MM (2 planchas 240x165cm) impreso  
 Ancho total MONTADO: 80cm / Prof: 48cm / altura total: 90cm



c/Casp 54 1ª B - 08010 Barcelona +34 931 791 992  
 e-mail: info@egueyseta.com

Proyecto  
 Espacio Promocional Endutex  
 CPrint!  
 Cliente:  
 Endutex Ibérica

Locación  
 Madrid

Fecha  
 Agosto 2014

Exp.No. Fase  
 2189 Proyecto

Escala Unidades Area  
 1:20 Cm 78 m2

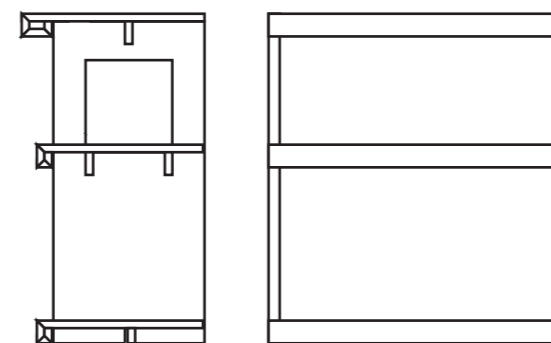

VISTA LATERAL VISTA FRONTAL

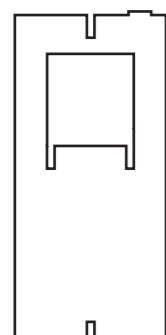

2uds  
 Montantes (40x86cm)  
 Panel de Abeja 30mm  
 TOTAL PLANCHAS: 0,28 ud

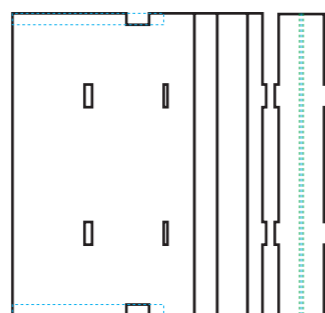

1ud  
 Estante inferior  
 Aviplex 9,3mm

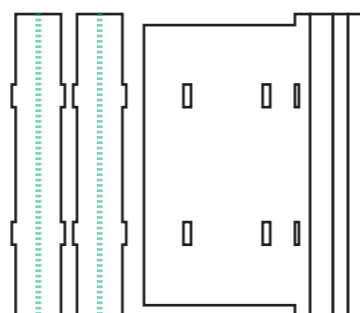

1ud  
 Estante intermedio  
 Aviplex 9,3mm

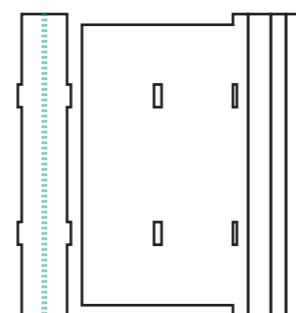

1 ud  
 encimera  
 Aviplex 9,3mm

TOTAL: 1PLANCHAS AVIPLEX (165x240cm)

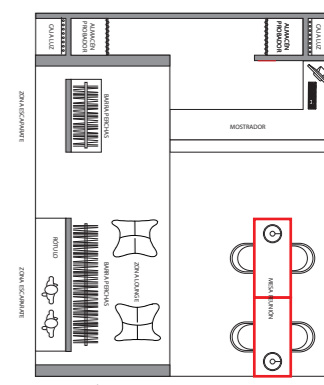

Contenido  
 DETALLE MOBILIARIO

Plano No.

015

