

# INNENSTUCK KATALOG 2021/22

Stuck aus:  
Naturgips /  
Alabaster-Modellgips,  
glasfaserverstärkt,  
unbehandelt,  
Baustoffklasse  
A1, nicht brennbar.



[stuckhandel.de](https://stuckhandel.de)

1268 (en 1,82 ml)  
FRISE TAJ MAHAL  
27,2 cm de largeur



M423  
ROSACE  
89 x 89 cm



D632 & D633 (en 2ml)  
Corniche  
20 x 20 cm  
30 x 30 cm



D903 (en 2 ml)  
Corniche  
32 x 21 cm



M401P  
120 x 120 cm  
Stratistaff



DÉCLINAISON  
DE LA ROSACE  
M401 POUR UN  
ENCASTREMENT  
OPTIMAL !



M604

> Rosace Ø 162 cm  
Stratistaff

D658 (en 2 ml)

Corniche  
19 x 38 cm



PL319  
Plafonnier



180 cm

80,5 cm

80,5 cm

81,2 cm

100 cm

CORNICHES CONTEMPORAINES

D568 (en 2 ml)

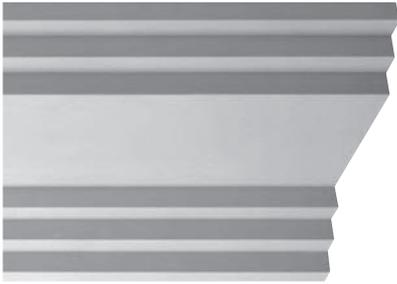
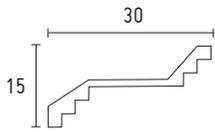

D891 (en 2 ml)

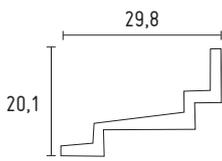

D564 (en 2 ml)

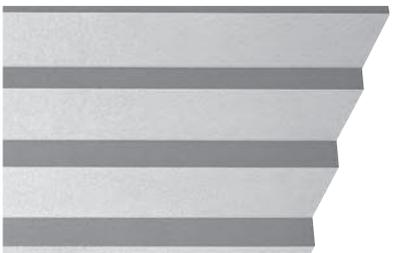
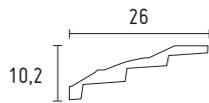

D567 (en 2 ml)

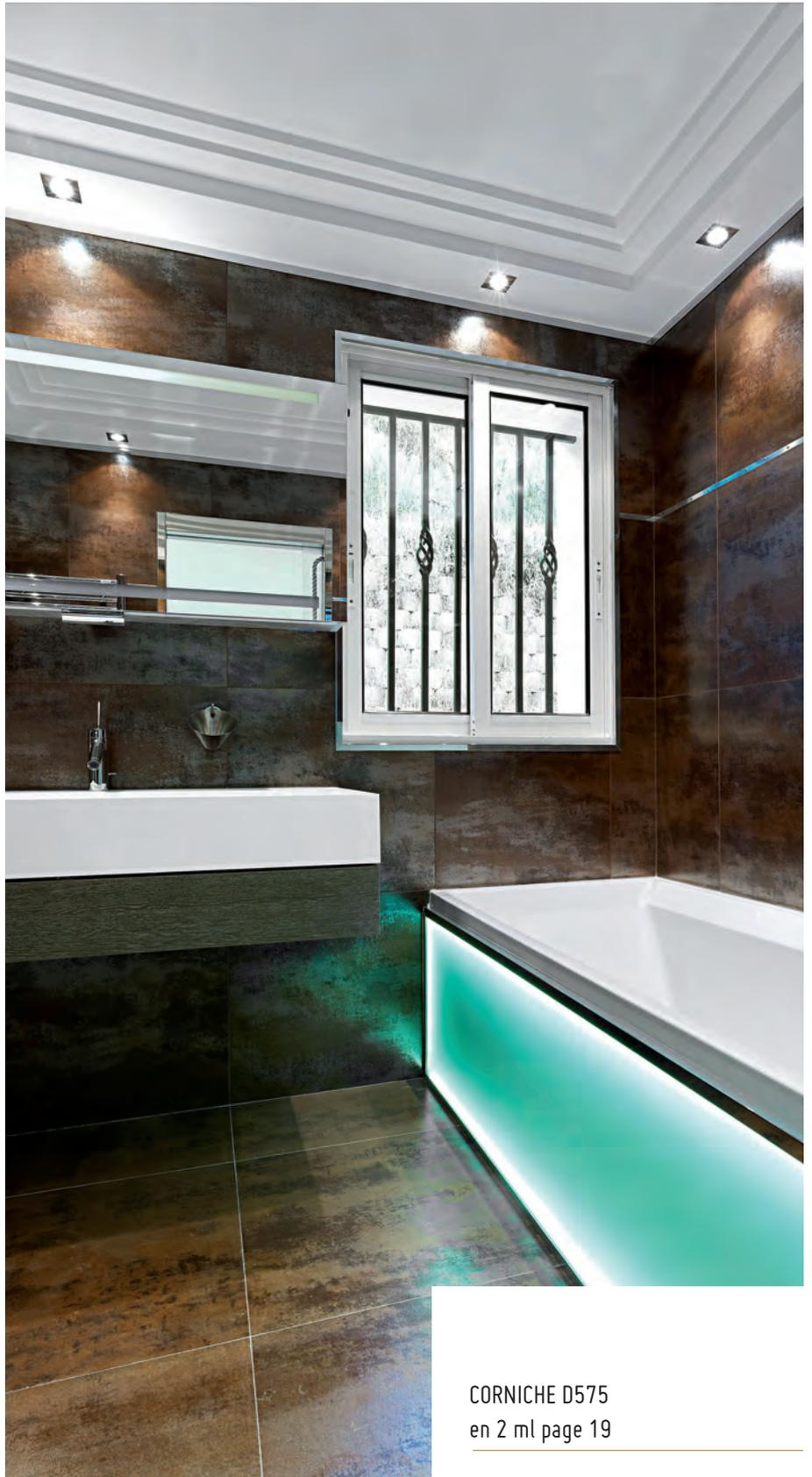
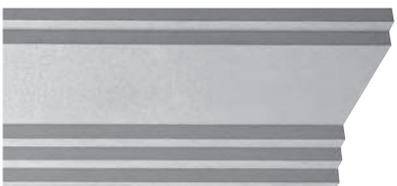
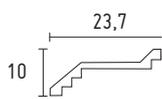

CORNICHE D575  
en 2 ml page 19

D577 (en 2 ml)

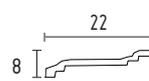

D579 (en 2 ml)

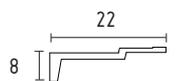

D901 (en 2 ml)

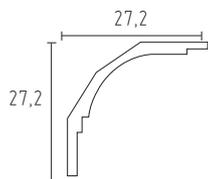

D576 (en 2 ml)

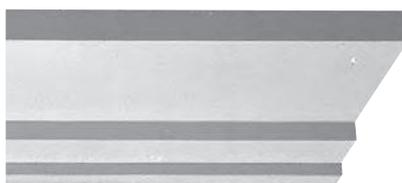

D563 (en 2 ml)



D565 (en 2 ml)

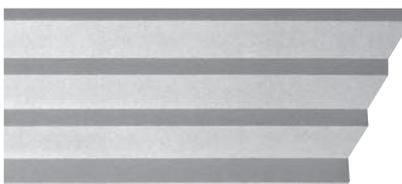

D580 (en 2 ml)



D720 (en 2 ml)

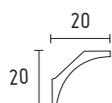

D562 (en 2 ml)

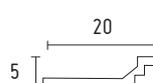

D575 (en 2 ml)

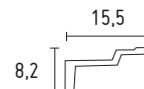

D718 (en 2 ml)

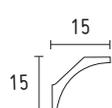

D578 (en 2 ml)

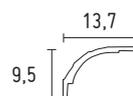

D620 (en 2 ml)



D631 (en 2 ml)

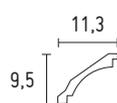

D621 (en 2 ml)

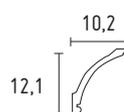

D705 (en 2 ml)

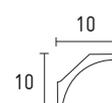

D706 (en 2 ml)



D561 (en 2 ml)

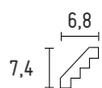

D555 (en 1,50 ml)



# CORNICHES À ÉCLAIRAGE INDIRECT

D708 (en 2 ml)

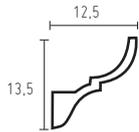

D749 (en 2 ml)

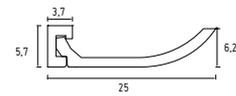

D709 (en 2 ml)

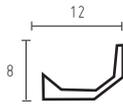

SDPA1 (en 1.20 ml)  
Vendus en carton de 2

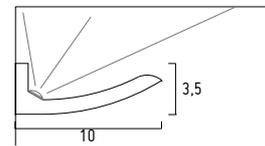

SCHEMA DE PRINCIPE D709

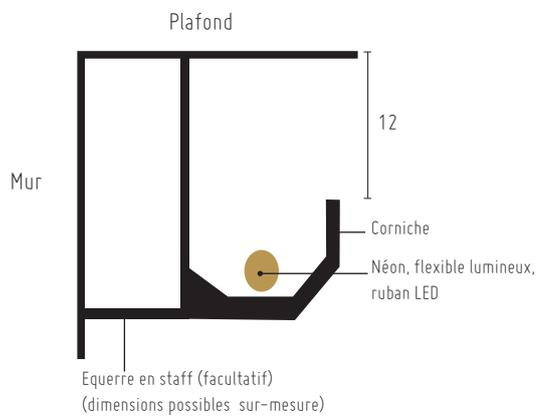

SDPA2 (en 1.20 ml)  
Vendus en carton de 2

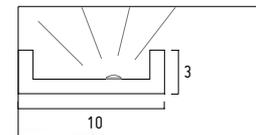

D710 (en 2 ml)



SDPA3 (en 1.20 ml)  
Vendus en carton de 2

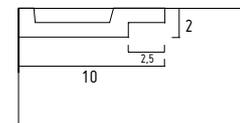

D748 (en 2 ml)

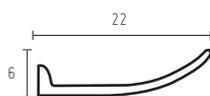

SDPA4 (en 1.20 ml)  
Vendus en carton de 2

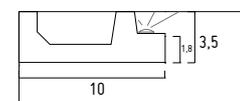

D101 (en 2 ml)

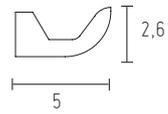

D102 (en 2 ml)

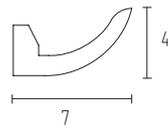

D103 (en 2 ml)

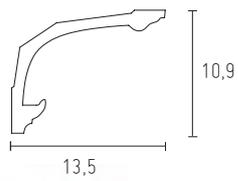

D104 (en 2 ml)

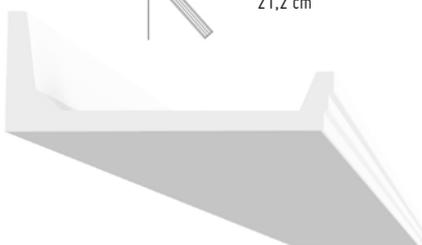
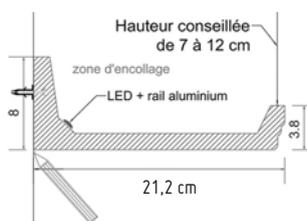

D105 A & B (en 2 ml)

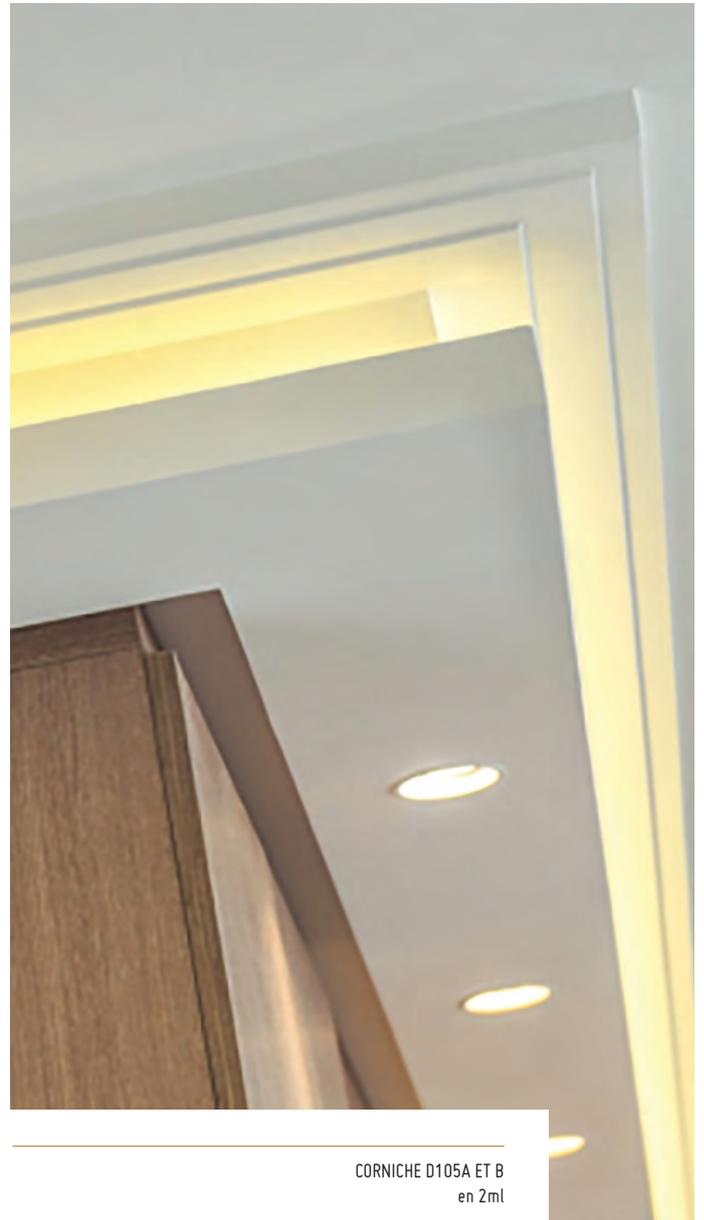
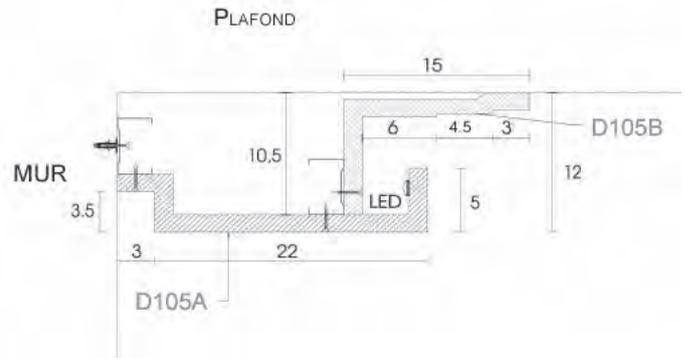

CORNICHE D105A ET B  
en 2ml

# CORNICHES À ÉCLAIRAGE INDIRECT

D106 (en 2 ml)

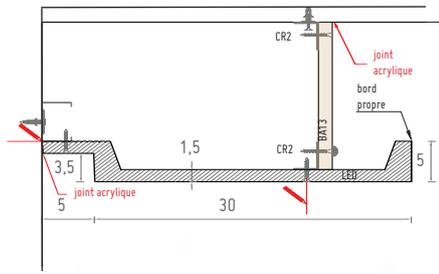

D107 (en 2 ml)

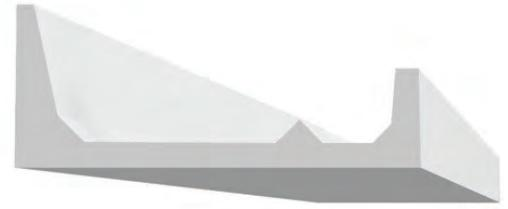
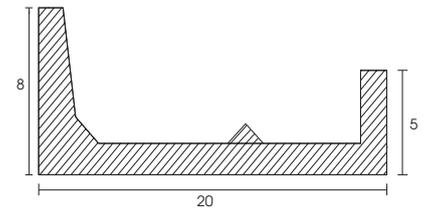

D108 (en 2 ml)

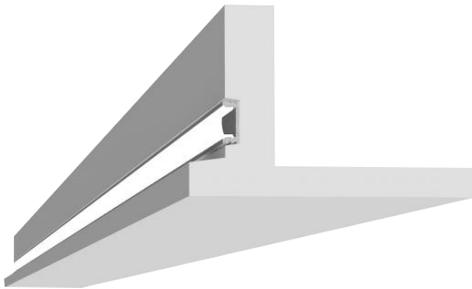
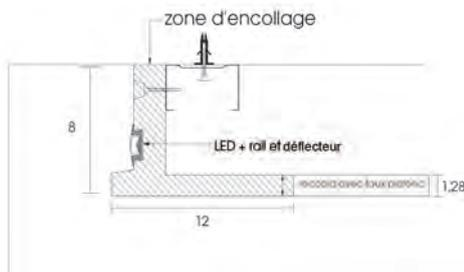

D110 (en 2 ml)

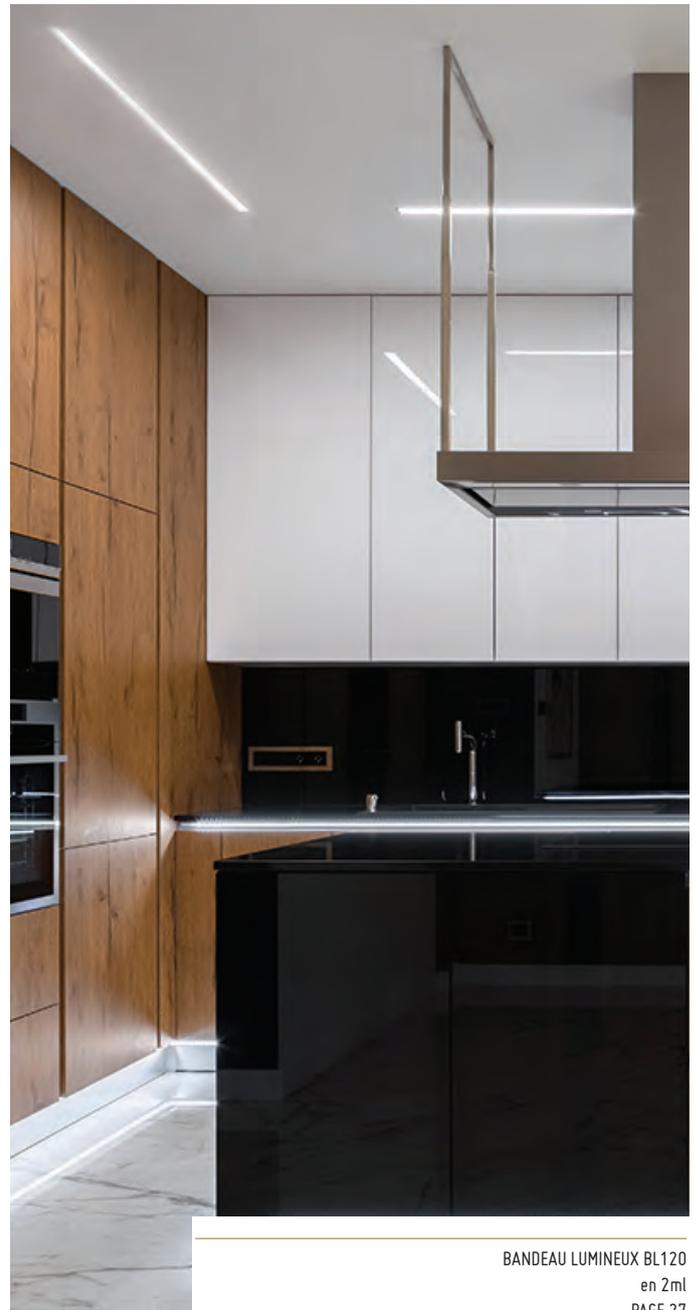
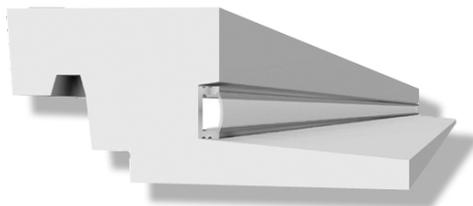
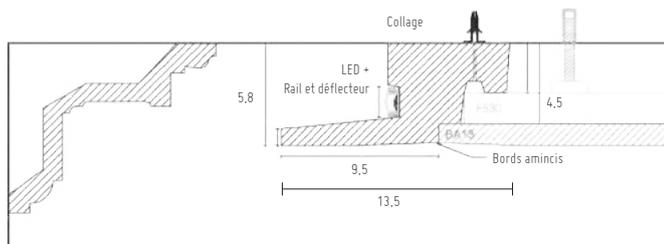

BANDEAU LUMINEUX BL120  
en 2ml  
PAGE 27

## PROFILS LUMINEUX COMPOSABLES

EMB95 (en 2 ml) > 9,7 x 4 cm  
 EBL0430 (en 2 ml) > 30 x 4 cm

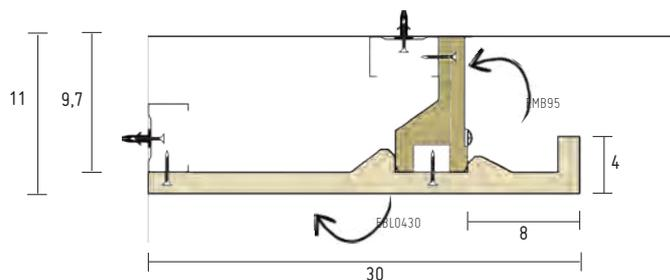

## BANDEAUX LUMINEUX COMPOSABLES

Les bandeaux lumineux sont des profils pouvant se poser en relief ou à fleur de vos murs et plafonds.

BL120 (en 2 ml)

Profil à associer à un rail en aluminium avec déflecteur en polycarbonate et un flexible LED.

12 x 2,5 cm | en 2 ml

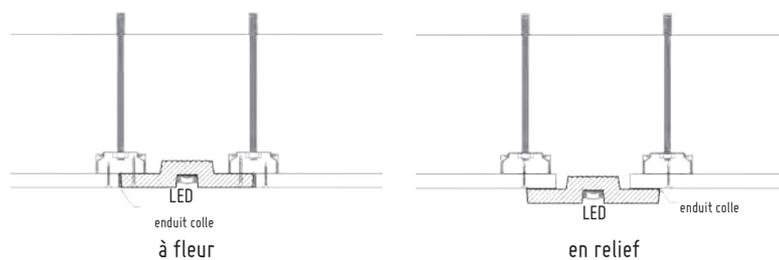
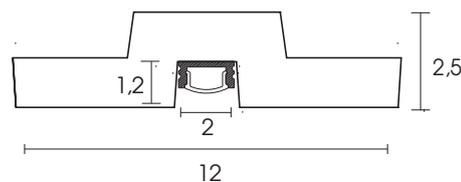

BL122 (en 2 ml)

12 x 2 cm | en 2 ml

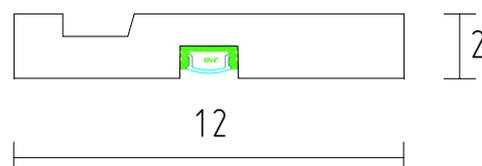

# CORNICHES À ÉCLAIRAGE INDIRECT

BL130 (en 2,6 ml)  
7 x 5 cm

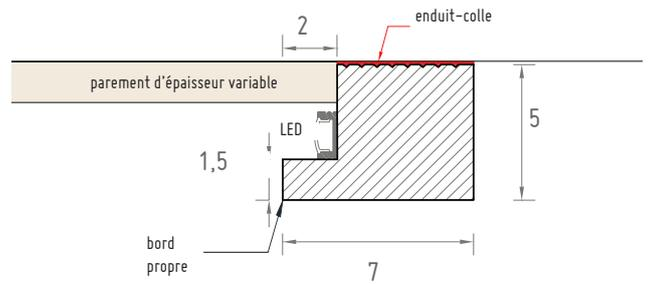

BL131 (en 2,5 ml)  
10 x 7 cm

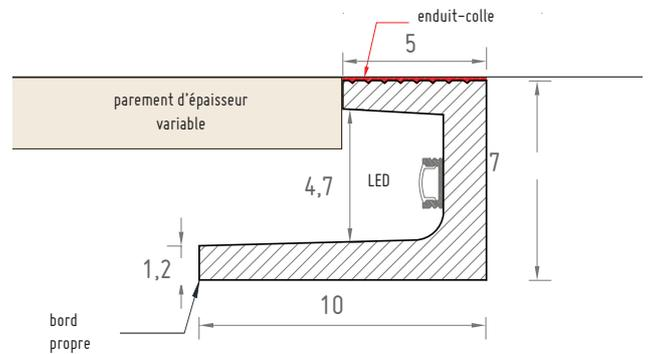
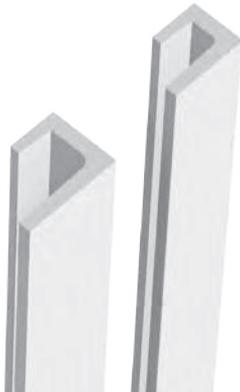

BL132 (en 2,5 ml)  
8 x 5,5 cm

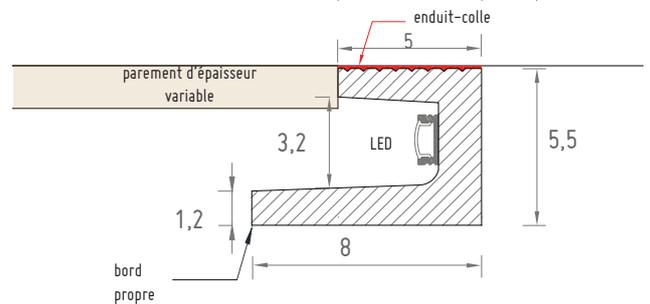
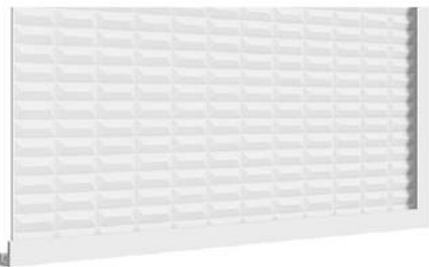

BL160 (en 2 ml)  
19 x 6 cm

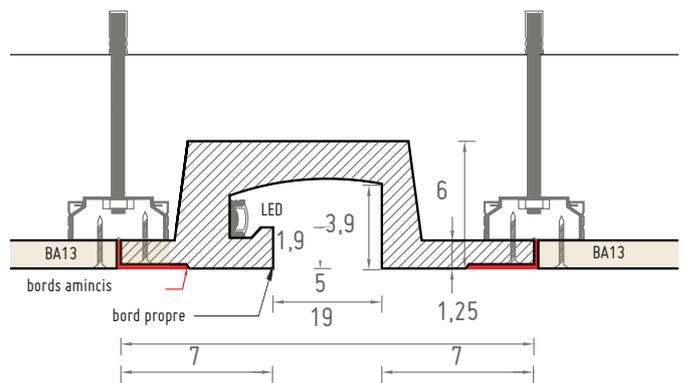
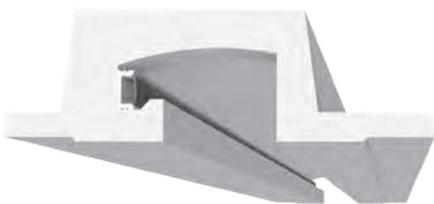

BL180 (en 2ml)  
27,1 x 6,6 cm | en 2 ml

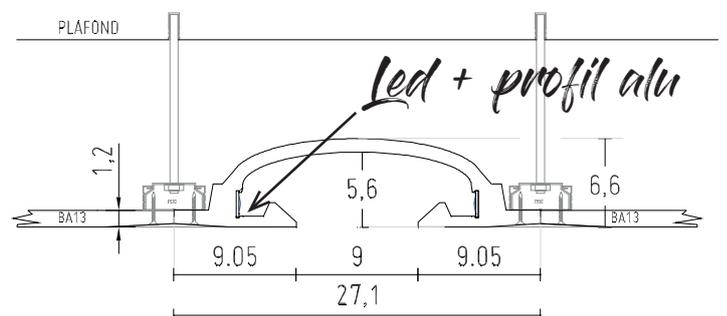

BL170 (en 2 ml)  
19,5 x 4,7 cm

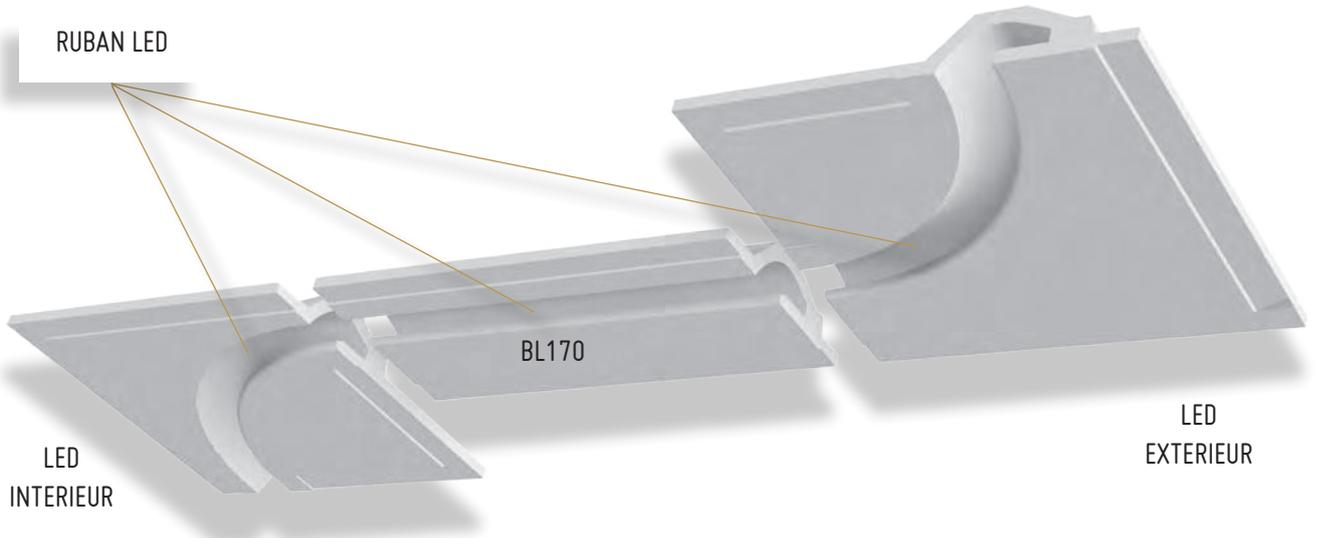
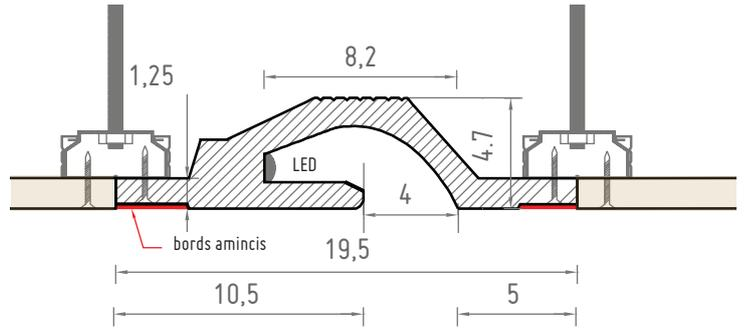

BL170R25I

Gorge lumineuse cintrée de  
25 cm de rayon Led Intérieur  
34 x 34 cm

BL170R25E

Gorge lumineuse cintrée de  
25 cm de rayon Led Extérieur  
35,5 x 35,5 cm

BL170R50I

Gorge lumineuse cintrée de  
50 cm de rayon Led Intérieur  
59 x 59 cm

BL170R50E

Gorge lumineuse cintrée de  
50 cm de rayon Led Extérieur  
60,5 x 60,5 cm

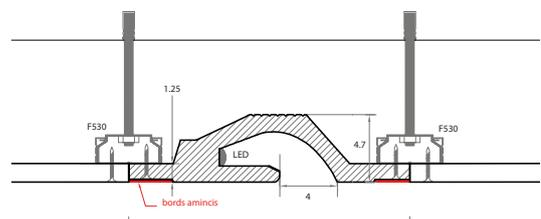

LED INTERIEUR

LED EXTERIEUR

BL170  
en 2 ml

D892 (en 2 ml)

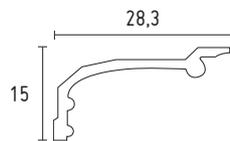

D560 (en 2 ml)

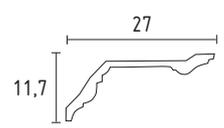

D900 (en 2 ml)

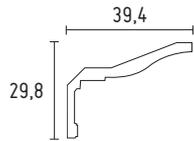

D802 (en 2 ml)



D601 (en 2 ml)

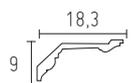

*Le savez-vous ?*

Toutes nos corniches contemporaines, classiques et ornementées peuvent être fabriquées sur-mesure !  
Renseignez-vous auprès de votre agence Staff Décor !

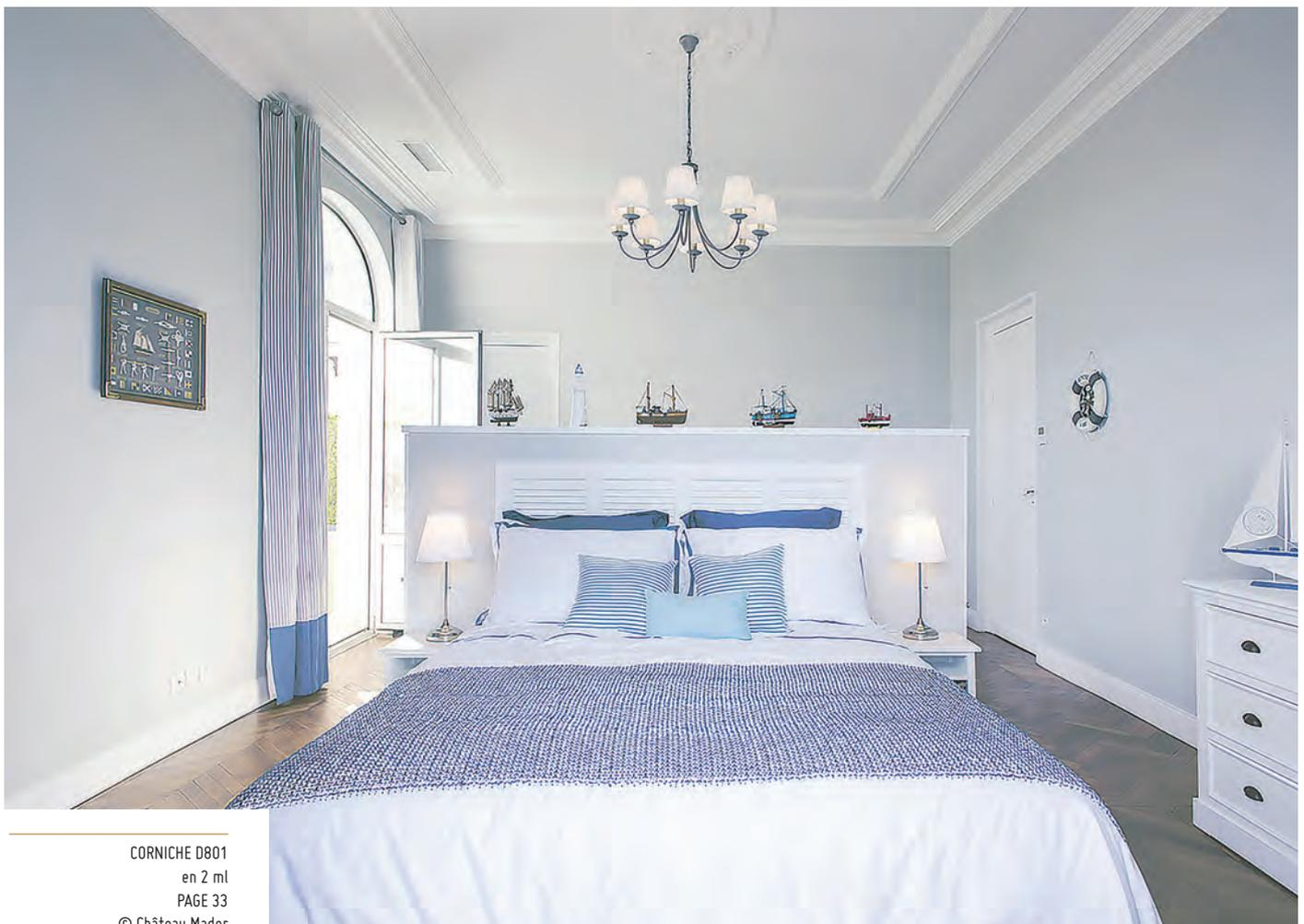

CORNICHE D801  
en 2 ml  
PAGE 33  
© Château Mader

D605 (en 2 ml)



D609 (en 2 ml)

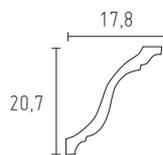

D626 (en 1,75 ml)

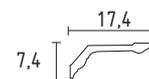

D574 (en 2 ml)

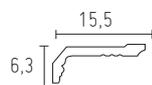

D608 (en 2 ml)



D830 (en 2 ml)



D611 (en 1,75 ml)



D604 (en 2 ml)

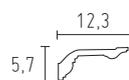

D545 (en 1,75 ml)

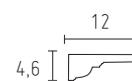

D612 (en 2 ml)



D614 (en 1,75 ml)

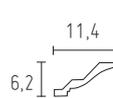

D625 (en 1,75 ml)



D610 (en 1,75 ml)

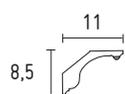

D707 (en 2 ml)



D630 (en 1,75 ml)



D704 (en 2 ml)



D520 (en 1,75 ml)



D703 (en 1,75 ml)



# CORNICHES CLASSIQUES

## ÉCOINÇON DE CORNICHE D880A

Angle : 80 x 80 cm

Hauteur : 18 cm

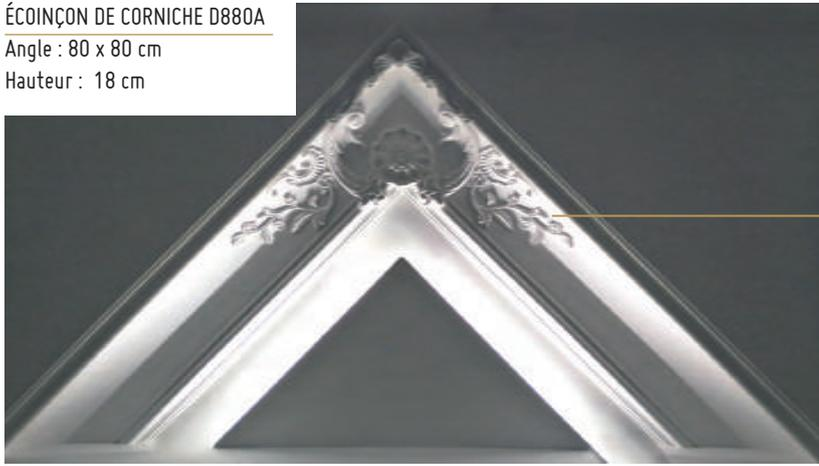

D880 (en 2 ml)

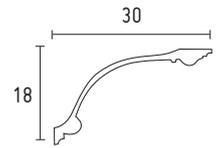

D654 (en 2 ml)

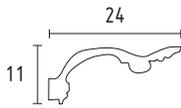

D651 (en 2 ml)

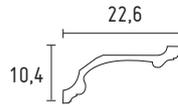

D652 (en 2 ml)

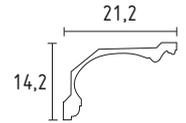

D650 (en 2 ml)

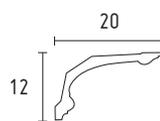

D606 (en 2 ml)

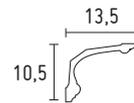

D624 (en 1,75 ml)

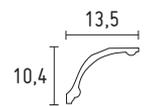

D616 (en 1,75 ml)

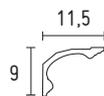

D607 (en 2 ml)

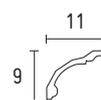

D702 (en 1,75 ml)

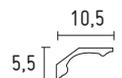

D623 (en 1,75 ml)

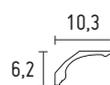

D622 (en 1,75 ml)

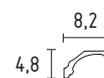

Pour les corniches D601, D606, D611, D616, D702, D707, vous pouvez leur associer un angle rentrant et sortant (par exemple, R601 et S601 pour la corniche D601...).

Angle rentrant  
R702

Angle sortant  
S702



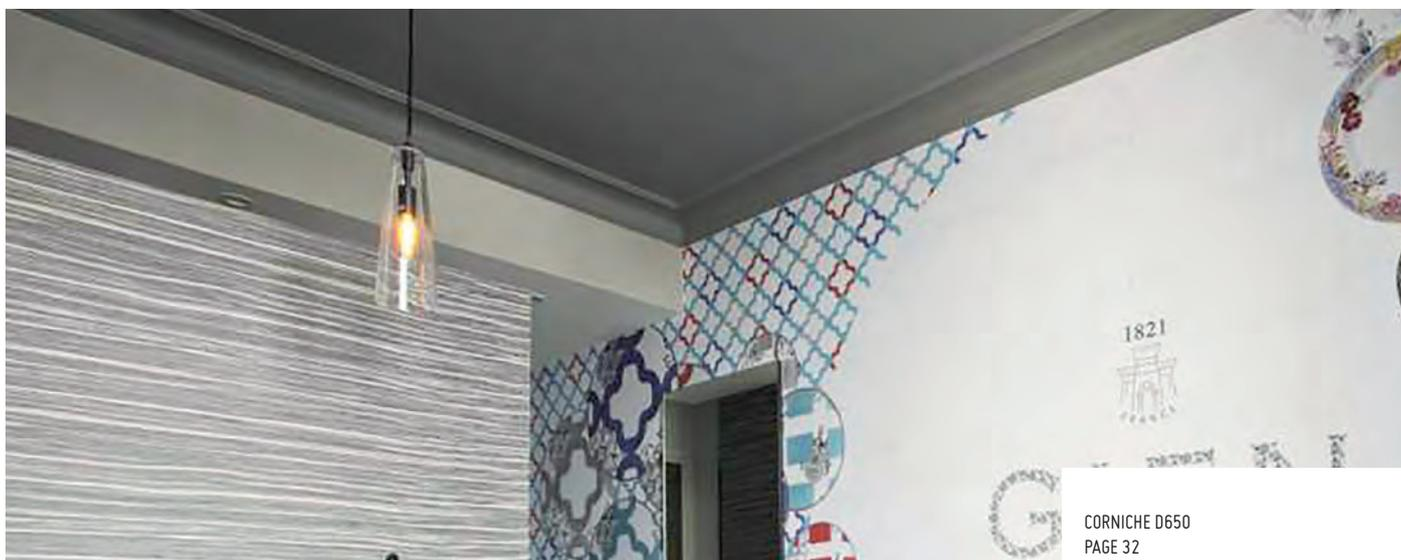

CORNICHE D650  
PAGE 32

D886 (en 2 ml)

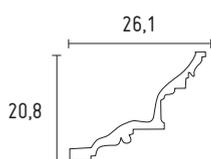

D896 (en 2 ml)



D653 (en 2 ml)

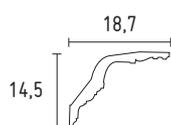

D888 (en 2 ml)

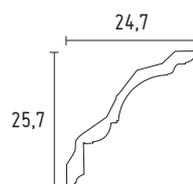

*Corniches pour  
grande  
hauteur  
sous plafond !*

D801 (en 2 ml)



D657 (en 2 ml)

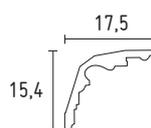

D820 (en 2 ml)

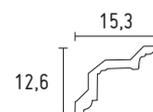

D656 (en 2 ml)



D717 (en 2 ml)



D713 (en 2 ml)



# CORNICHES ORNEMENTÉES

D899 (en 2 ml)

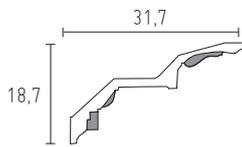

D898 (en 2 ml)

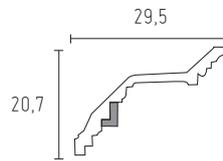

D889 (en 2 ml)

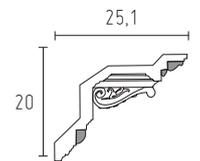

D815 (en 2 ml)

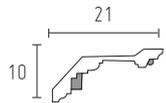

D814 (en 2 ml)

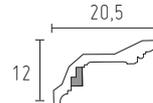

D569 (en 2 ml)

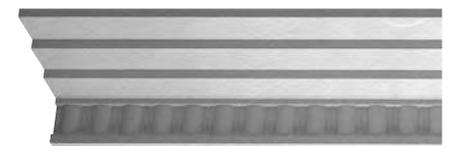
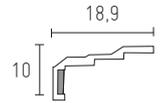

D810  
(en 2 ml)

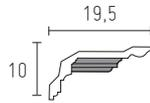

D515 (en 2 ml)

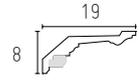

D902 (en 2 ml)

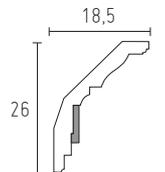

D628 (en 2 ml)



D629 (en 2 ml)

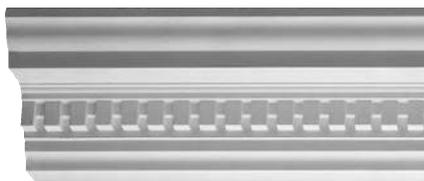
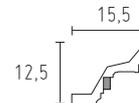

D531 (en 2 ml)

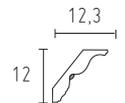

D840 (en 2 ml)

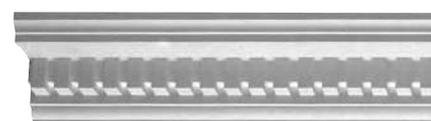
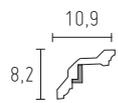

D715 (en 1,75 ml)

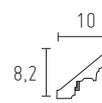

D617 (en 1,75 ml)

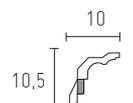

D897 (en 2 ml)

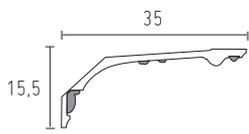

D895  
(en 2 ml)

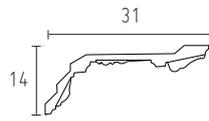

D885 (en 2 ml)

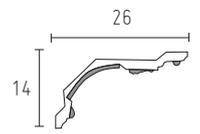

D894 (en 2 ml)

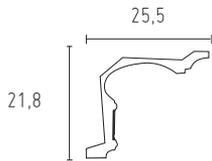

D893  
(en 2 ml)

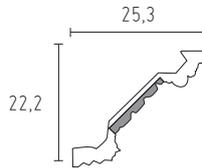

D884  
(en 2 ml)

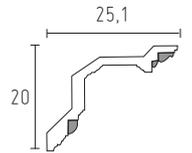

D844 (en 2 ml)

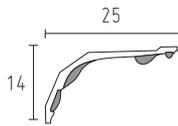

D570 (en 2 ml)

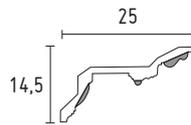

D566 (en 2 ml)

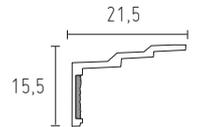

D843 (en 2 ml)

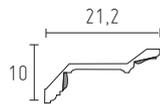

D813 (en 2 ml)

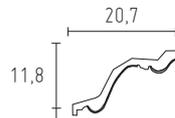

D510 (en 2 ml)

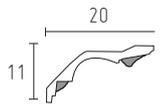

D812 (en 2 ml)

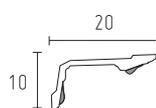

D505 (en 2 ml)

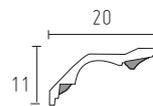

D845 (en 2 ml)

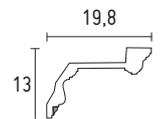

# CORNICHES ORNEMENTÉES

D846 (en 2 ml)

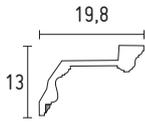

D627 (en 2 ml)

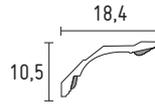

D716 (en 2 ml)

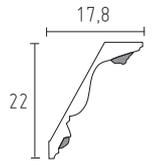

D835 (en 2 ml)

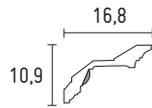

D818 (en 2 ml)

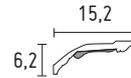

D712 (en 2 ml)

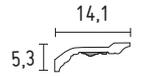

D615 (en 1,75 ml)

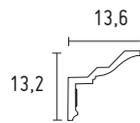

D655 (en 2 ml)

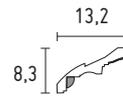

D530 (en 2 ml)

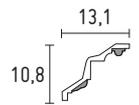

D513 (en 1,75 ml)

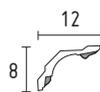

D525 (en 1,75 ml)



D535 (en 1,75 ml)



D711 (en 2 ml)

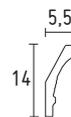

D540 (en 1,75 ml)



D550 (en 1,50 ml)



D890 (en 2 ml)

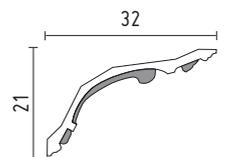

ÉCOINÇON DE CORNICHE D890A

Angle : 80 x 80 cm  
Hauteur : 21cm

# MOULURES LISSES

1365 (en 1,75 ml)



1103 (en 1,50 ml)



1344 (en 1,50 ml)



1364 (en 2,15 ml)



1209 (en 1,75 ml)



1156 (en 1,50 ml)



1367 (en 2,15 ml)



1108 (en 2,15 ml)



1345 (en 2 ml)



1324 (en 2 ml)



1130 (en 2,15 ml)



1125 (en 2,15 ml)



1366 (en 2,15 ml)



1202 (en 1,50 ml)



1155 (en 1,50 ml)



1201 (en 1,50 ml)



1120 (en 2,15 ml)



1343 (en 1,50 ml)



1101 (en 1,50 ml)



1124 (en 2,15 ml)



1107 (en 1,50 ml)



1102 (en 1,50 ml)



1121 (en 2,15 ml)



1207 (en 1,50 ml)



1206 (en 1,50 ml)



1210 (en 1,75 ml)



1220 (en 2,50 ml)



1200 (en 1,50 ml)



1166 (en 1,50 ml)



1221 (en 2,50 ml)



1380 (en 1,50 ml)



 Retrouvez nos moulures de 2,15 ml (couvre-joints) page 106 !

# MOULURES ORNEMENTÉES

1208 (en 1,50 ml)



1110 (en 1,25 ml)



1111 (en 1,35 ml)



1112 (en 1,15 ml)

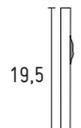

1113 (en 1,65 ml)



1205 (en 1,25 ml)



1104 (en 1,50 ml)



1105 (en 1,50 ml)



1106 (en 1,50 ml)



1109 (en 1,50 ml)



1114D ou 1114G (en 1,50 ml)



1204 (en 1,50 ml)



1157 (en 1,50 ml)



1150 (en 1,55 ml)

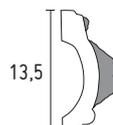

1151 (en 1,65 ml)

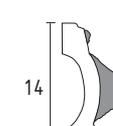
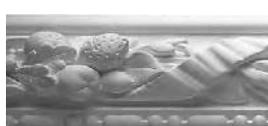

1301 (en 1,50 ml)

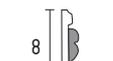

1302 (en 1,50 ml)



1303 (en 1,50 ml)



1304 (en 1,50 ml)

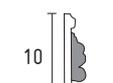

1305 (en 1,50 ml)



1306 (en 1,50 ml)



1310 (en 1,50 ml)



1321 (en 1,50 ml)



1322 (en 1,50 ml)



1323 (en 1,50 ml)



1325 (en 1,50 ml)



1326 (en 1,50 ml)



1327 (en 2,00 ml)



1328 (en 1,75 ml)



1329 (en 1,50 ml)



1330 (en 1,50 ml)



1331 (en 1,50 ml)



1332 (en 1,70 ml)

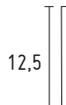

1333 (en 1,50 ml)



1340 (en 1,80 ml)



1374 (en 1,25 ml)

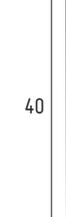

1341 (en 1,50 ml)



1342 (en 1,80 ml)



1346 (en 1,50 ml)



1347 (en 1,50 ml)



1348 (en 1,50 ml)



1349 (en 1,50 ml)



1203 (en 2 ml)



1334 (en 2 ml)



1335 (en 2 ml)



1371 (en 1,80 ml)



1320 (en 1,50 ml)

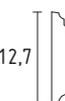

1373 (en 1,70 ml)



1372 (en 1,70 ml)

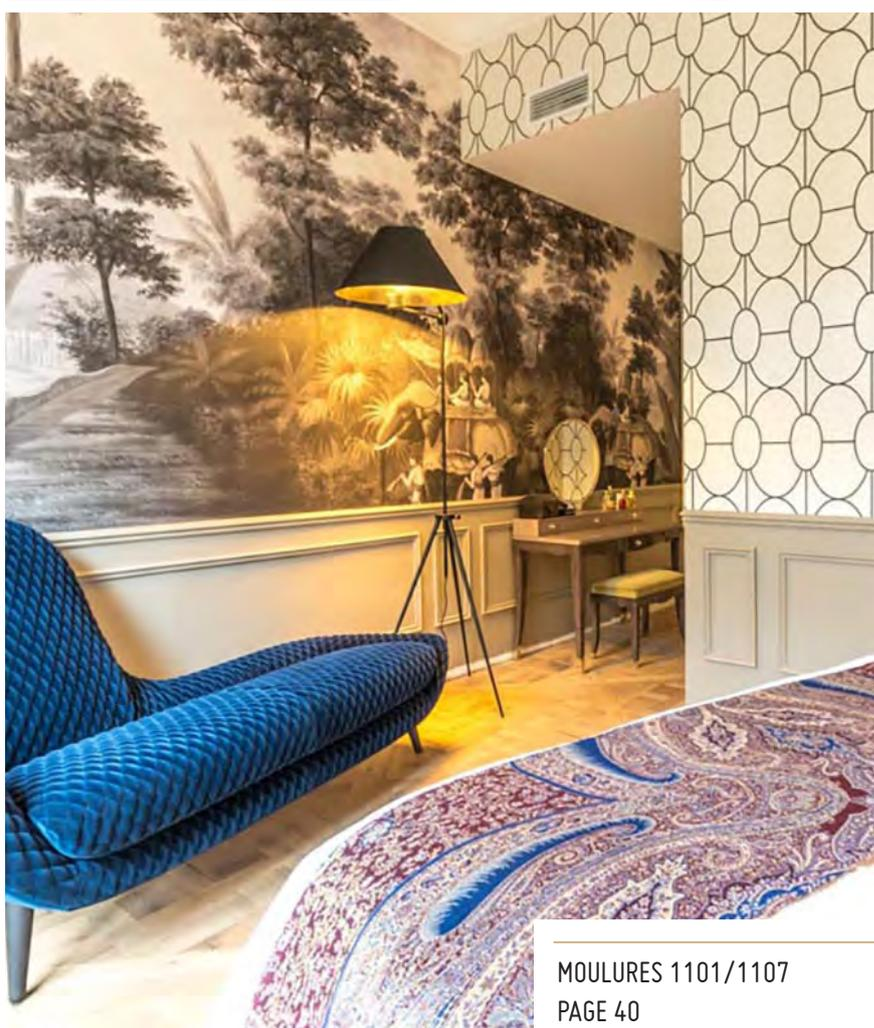
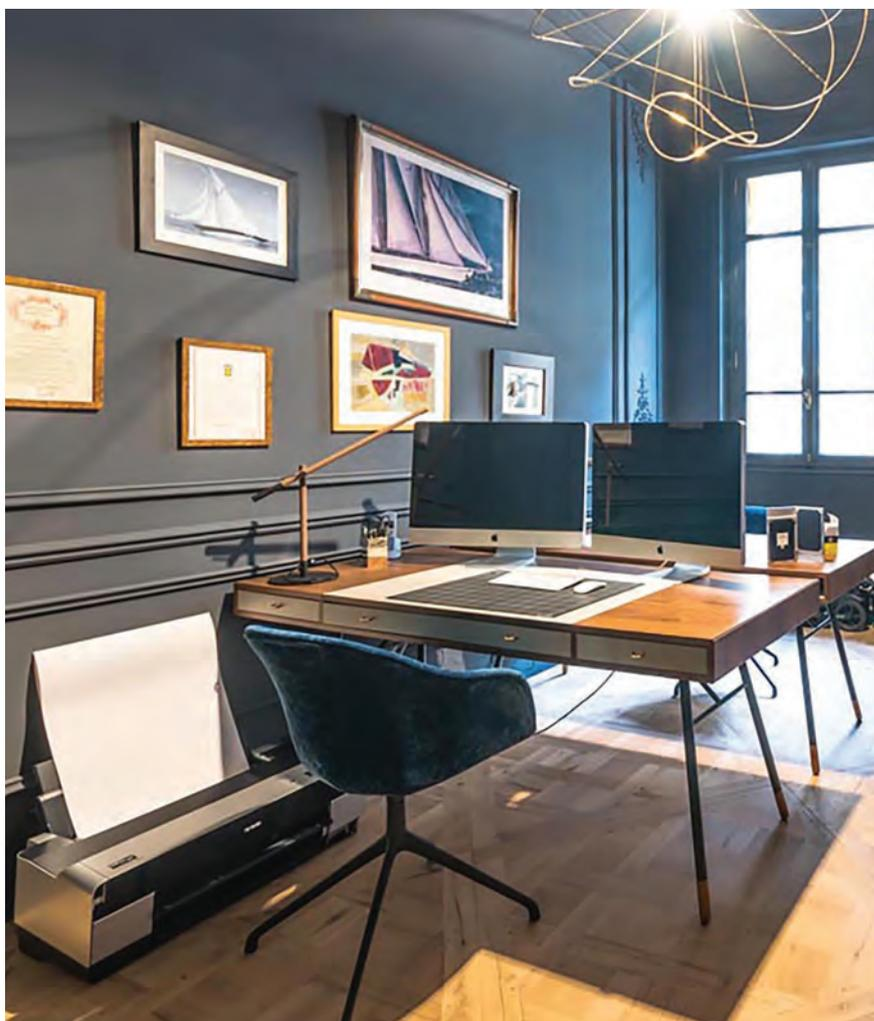

MOULURES 1101/1107  
PAGE 40

ANGLES & DOUCINES DE MOULURES

1150 (en 1,55 ml)



1104 (en 1,50 ml)

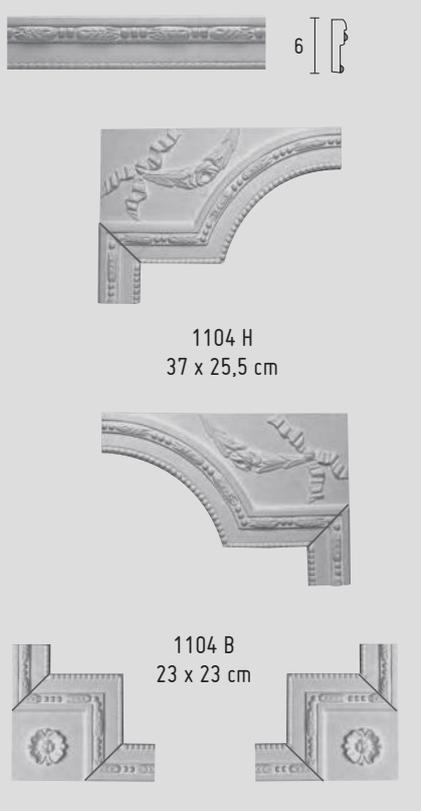

1103 (en 1,50 ml)

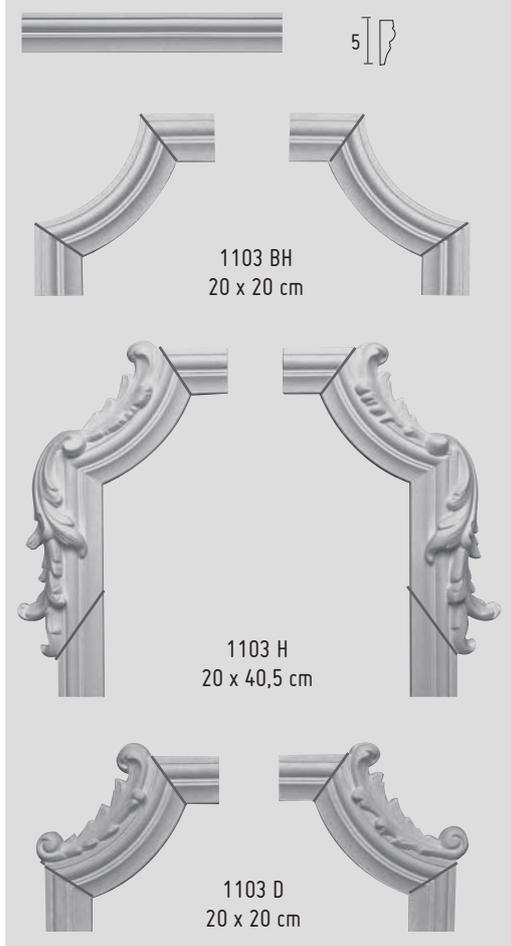

1151 (en 1,65 ml)

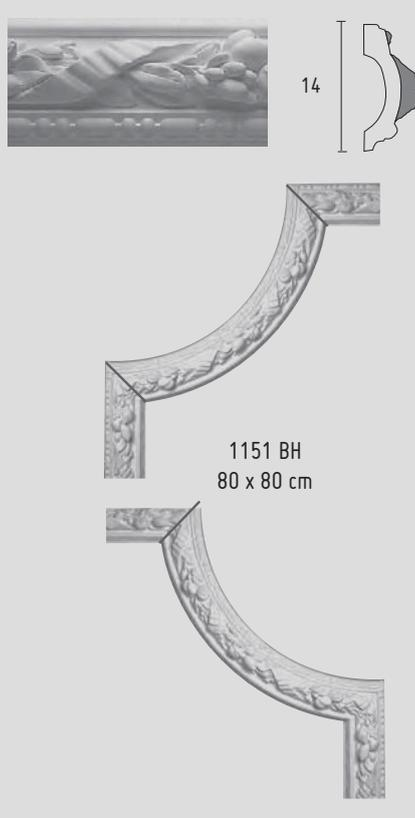

1105 (en 1,50 ml)

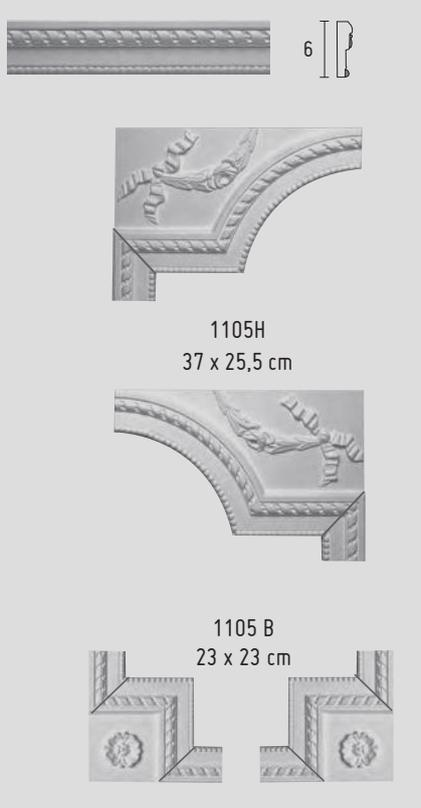

1210 (en 1,75 ml)

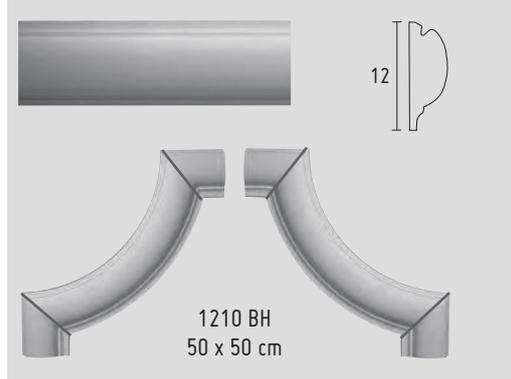

1200 (en 1,50 ml)



1206 (en 1,50 ml)

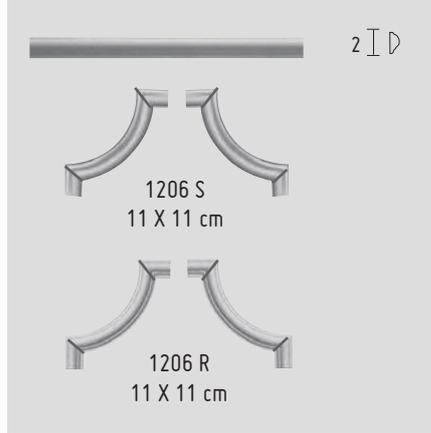

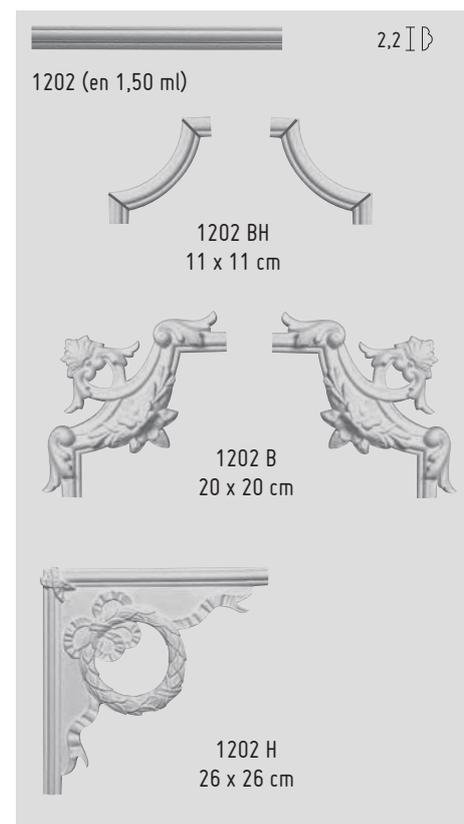
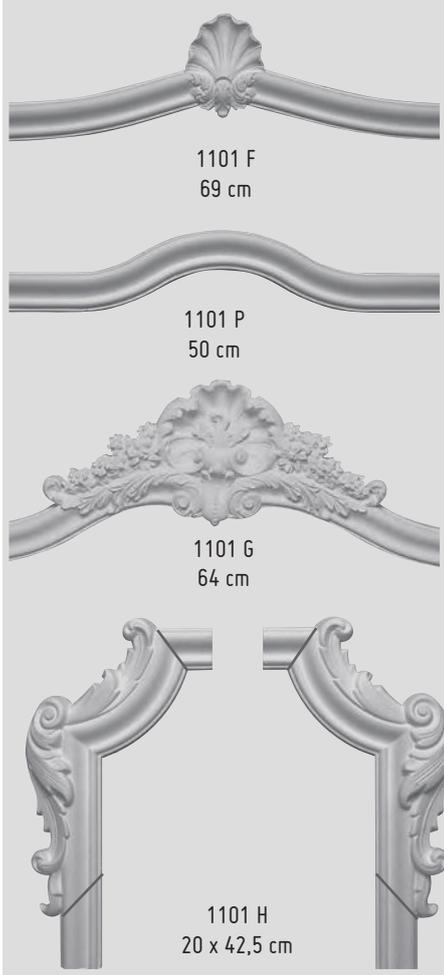
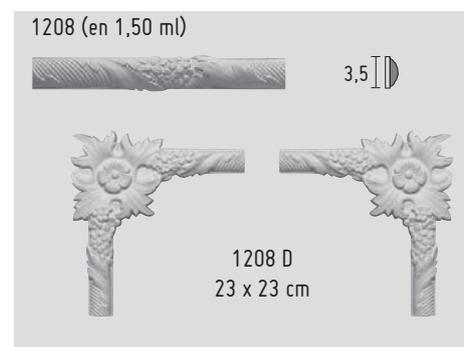
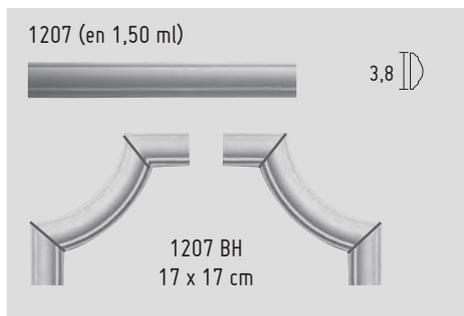
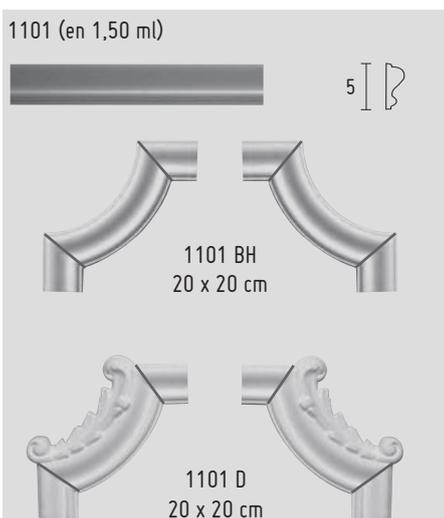
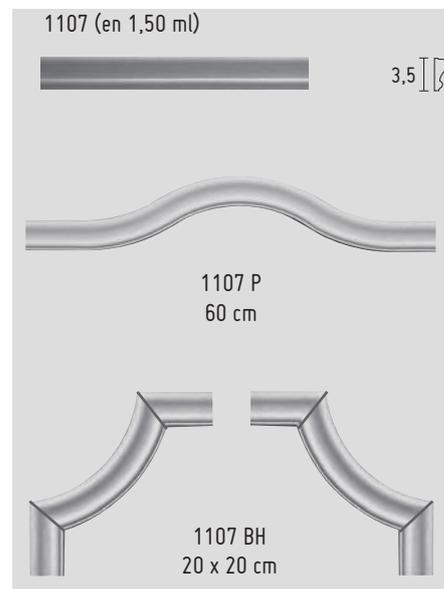
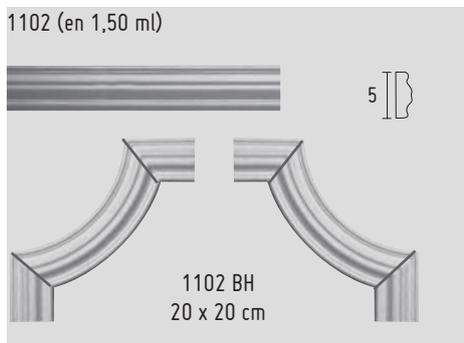
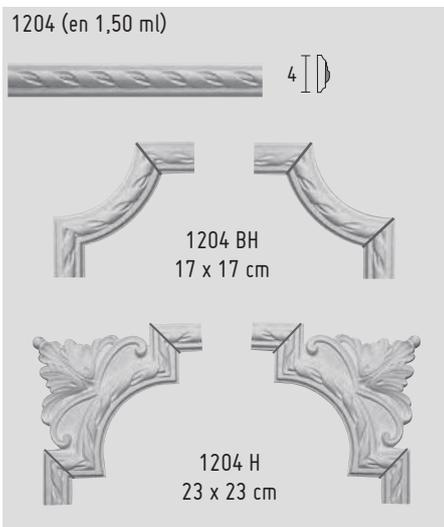

1420 M  
22 x 14 cm

1420 T  
28 x 17 cm



1420 H  
21 x 12 cm



1411 D  
8 x 12 cm



3800  
25,5 x 23,5 cm



1411 G  
8 x 12 cm



1410  
7,5 x 8,5 cm



1409  
13 x 18 cm



4200  
14 x 11 cm



4201  
11 x 17 cm



Mise en oeuvre

Pour la pose des angles, coupez les amorces comme indiqué ci-dessus par le trait gris.

# LES ROSACES & LES CAISSONS

ROSACE M405  
PAGE 57



# LES ROSETTES

---



1401 - ø 5,5 cm



1403 - ø 6 cm



1400 - ø 6 cm



M049 - ø 6 cm



1402 - ø 6,5 cm



1415 - ø 7 cm



1416 - ø 8 cm



1413 - 9 x 7 cm



1404 - ø 8,5 cm



1405 - ø 9 cm



M050 - ø 10 cm



1407 - 10,5 x 10,5 cm



1412 - ø 11,5 cm



1406 - ø 12 cm



1408 - ø 14 cm



M038 - ø 16 cm



1414 - ø 19 cm



M043 - ø 29 cm



M047 - ø 32 cm



M041 - ø 32 cm



M058 - ø 32,5 cm



M042 - ø 33 cm



M102 - ø 36 cm



M100 - ø 39 cm



M101 - ø 39 cm



M044 - ø 40 cm



M040 - ø 30 cm



M211 - ø 43,5 cm

ROSACES



M205 - ø 45 cm



M202 - ø 49 cm



M059 - ø 44 cm



M057 - ø 49 cm



M204 - ø 49 cm



M073 - ø 50 cm



M051 - ø 49,5 cm



M072 - ø 51 cm



M061 - ø 52 cm



M056 - ø 51,5 cm



M201 - ø 52 cm



M053 - ø 52 cm



M055 - 65 x 32 cm



M045 - 41 x 30 cm



M213 - ø 46 cm



M206 - ø 57 cm



M046 - 42 x 32 cm



M207 - 53 x 44 cm



M297 - ø 58 cm



M300 - ø 60 cm



M301 - ø 60 cm



M299 - ø 60 cm



M254 - ø 60 cm



M070 - ø 64 cm



M302 - ø 70 cm



M303 - ø 70 cm



M304 - ø 70 cm



M052 - ø 72,5 cm



 M401 - ø 90 cm



 M402 - ø 90 cm



 M403 - ø 87 cm





 M405 - ø 96 cm



ROSACE M405  
© Charles Cameron



ROSACE M400



 M400 - 100 x 70 cm





M209 - 64 x 48 cm



M071 - 88 x 74 cm



M210 - 60 x 41 cm



M068 - 55 x 39 cm



M039 - 59 x 38 cm



M069 - 72 x 42 cm



M203 - ø 50 cm



M048 - 57 x 32 cm



M208 - 51 x 40 cm



 M404 - ø 104 cm



 M067 - 91,5 x 46 cm



 M390 - 105 x 83 cm



 M255 - ø 84 cm



M296 - ø 63 cm



 M407 - 124 x 80 cm



M406 - 84 x 44 cm



M054 - 76 x 61 cm



M306 - ø 80 cm



M298 - 59 x 47 cm



M066 - ø 50 cm



M212 - ø 49 cm



M502 - 88,4 x 95,7 cm  
Livrée avec 3 hexagones en staff, M502H.  
Peut être vendu séparément.





M253 - ø 46 cm



M252 - ø 56 cm



M060 - ø 62 cm



M251 - ø 66 cm



M250 - ø 77 cm



ROSACE M501 - 80 x 80 cm  
© Hôtel Victor Hugo, Pontorson.

CARACTÉRISTIQUES  
TECHNIQUES

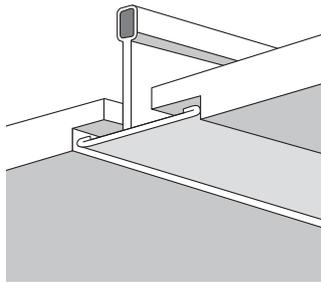

- > Composition : Plâtre armé de fibre de verre.  
Matériau naturel ne contenant aucune substance toxique.
- > Poids : Selon les modèles,  
compris entre 9 et 10 et 22 Kg/m<sup>2</sup>.
- > Réaction au feu : classement M0 et A1  
Non Combustible.
- > Type de montage : Sur ossature semi-cachée  
selon schéma ci-contre ou  
scellement traditionnel.



CAISSON 50.NIAG  
60 x 60 cm  
© The White House, Cannes

50.NIAG  
60 x 60 cm  
Niagara - H 10 cm - 7,7 kg.



50.SIER  
60 x 60 cm  
Sierra - H 9 cm - 7,9 kg.



50.050  
60 x 60 cm  
H 2 cm - 2,7 kg.



50.ATLA  
60 x 60 cm  
Atlas - H 3 cm - 5,4kg.



STAFF DÉCOR peut également réaliser à la demande, tout modèle spécifique de caisson de plafond.

# MOULURES ET FRISES



1250G ou D  
L 200 cm x H 15 cm



1253  
L 210 cm x H 39 cm



1254  
L 215 cm x H 26 cm



1252  
L 187 cm x H 63 cm



1251  
L 209 cm x H 35 cm



1271  
22 x 19 cm

Les écoinçons sont livrés séparément. Ils sont destinés à faciliter les raccords et les arrêts de la frise.

## ABAT-JOUR



1275  
L 150 cm x H 45 cm



Abat-jour 201

# ROSACES



M421  
ø 83 cm

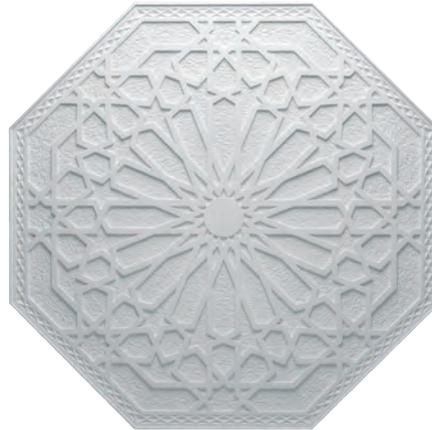

M422  
ø 100 cm



M420  
153 x 81 cm

# FRONTONS & CHAPITEAUX



B700  
Fronton 100 cm x 70 cm  
Flèche : 37 cm - corde : 71 cm



B702  
Fronton 166,5 cm x 68 cm  
Flèche : 52 cm - corde : 167 cm

1/2 chapiteau  
40.61  
22 cm x 11 cm x H 11 cm



B701  
Fronton 125 cm x 83 cm  
Flèche : 57 cm - corde : 95 cm

Demi-fût torsadé  
32.51  
ø 15 cm, H 200 cm



1/2 collerette basse  
45.51C



B703  
79 cm x 20,5 cm



COMPRENDRE NOS PRODUITS DE SOUBASSEMENTS & ENCADREMENTS MURAUX AFIN DE CHOISIR CELUI QU'IL VOUS FAUT

- 1 - Lambris décaissé
- 2 - Cimaïse
- 3 - Plinthe
- 4 - Intercalaire
- 5 - Plate bande simple côté
- 6 - Plate bande double côté
- 7 - Angle de plate bande
- 8 - Tête de pilastre
- 9 - Pilastre
- 10 - Cimaïse de stylobate
- 11 - Stylobate

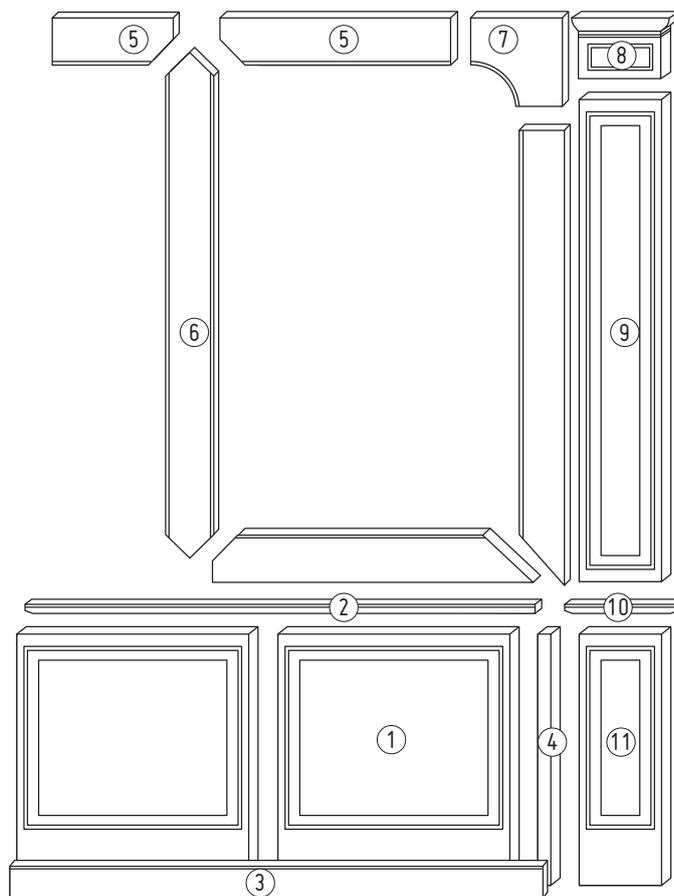

## PLATE BANDE, ANGLES DE PLATE BANDE & CIMAISES

Épaisseur : 1,5 cm

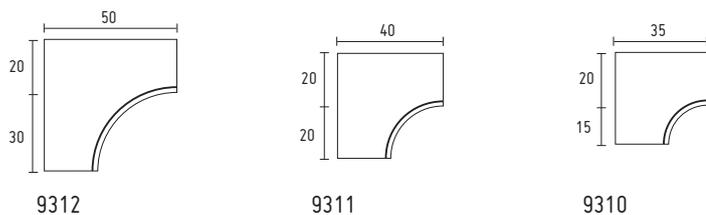

Épaisseur : 1,5 cm

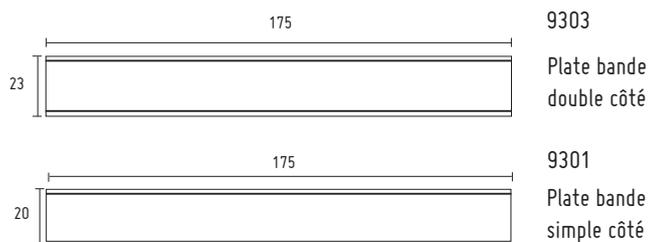

Existe en Plate bande simple étroite 9302

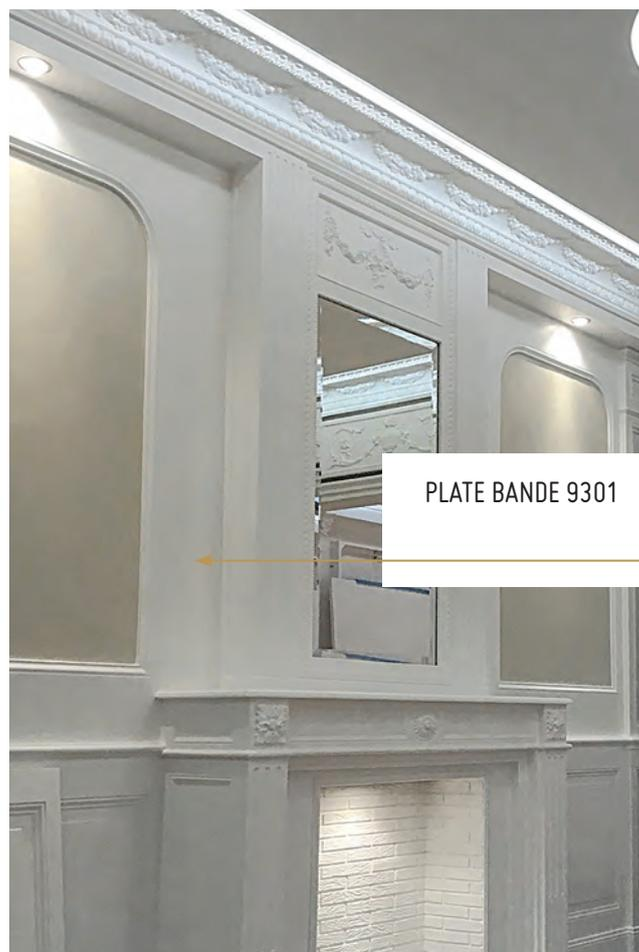
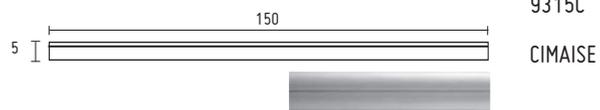

# LAMBRIS DÉCAISSÉS

SOUBASSEMENT 9222



3 Hauteurs disponibles : 55, 75 et 85 cm  
 (Hauteur du lambris sans cimaise)  
 Épaisseur : 2,3 cm

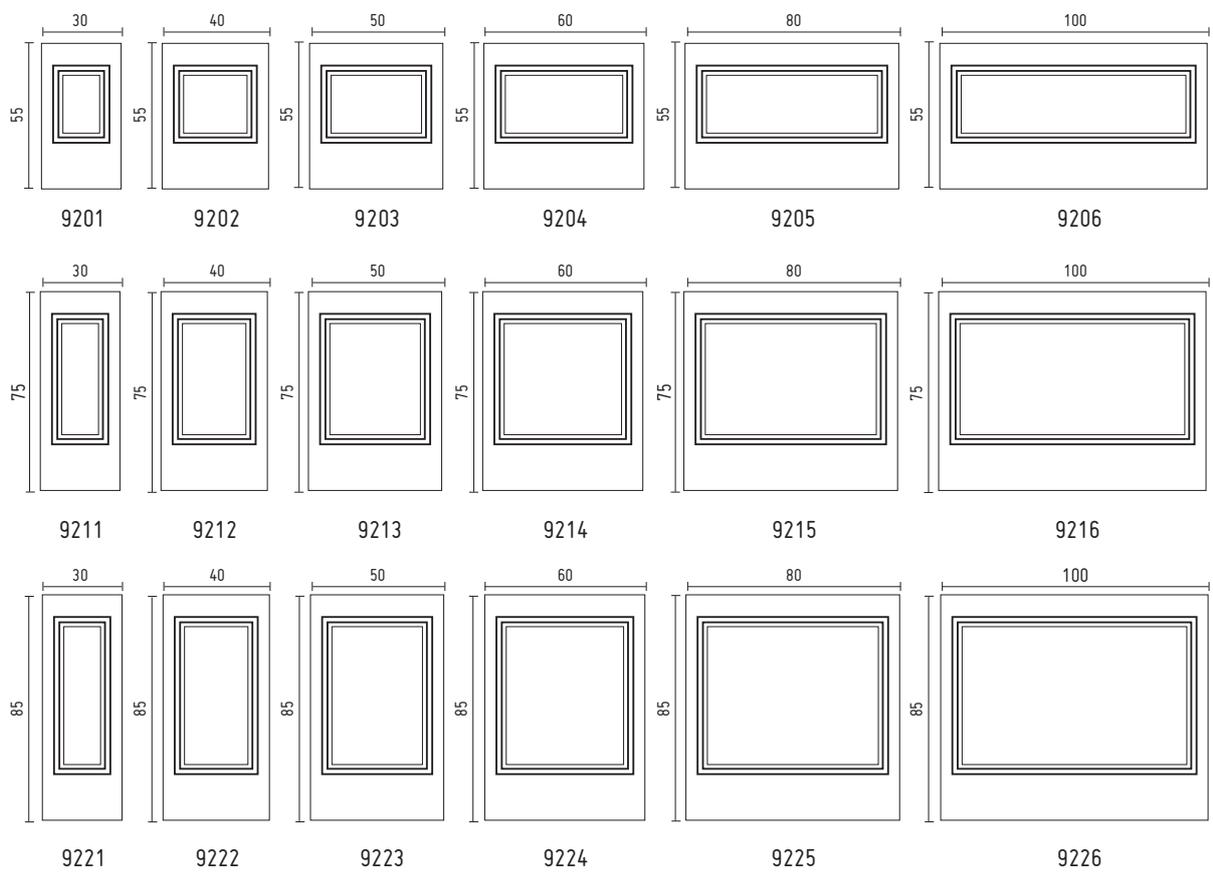

## Nos autres modèles de cimaises



1101C (en 1,50 ml)



1103C (en 1,50 ml)

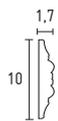

1145C (en 1,50 ml)

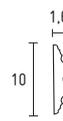

Nos cimaises sont vendues avec des bouts pour des finitions impeccables. Il vous suffit de les couper pour assembler les éléments entre eux !



SDC1 (en 1,20 ml)

Conditionnement en carton de 4 éléments



SDC2 (en 1,20 ml)

Conditionnement en carton de 4 éléments



*Sélectionnez votre profil & choisissez la dimension de votre panneau !*

Profil n°1



Profil n°2



Profil n°3



RÉFÉRENCE DES PANNEAUX			
Dimensions en cm	80x50	55x50	20x50
Profil n°1	9001	9003	9002
Profil n°2	9011	9013	9012
Profil n°3	9031 (83x50)	9033	9032

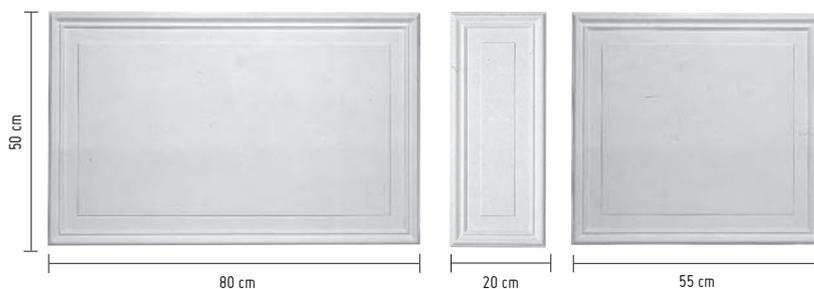

## Nos autres modèles de plinthes

PLIN08 (en 1,50 ml), hauteur 8 cm  
 PLIN10 (en 1,50 ml), hauteur 10 cm  
 PLIN12 (en 1,50 ml), hauteur 12 cm  
 PLIN15 (en 1,50 ml), hauteur 15 cm  
 PLIN20 (en 1,50 ml), hauteur 20,5 cm



Angles sortants :  
 PLIN10A (pour PLIN10)  
 PLIN12A (pour PLIN12)  
 PLIN15A (pour PLIN15)  
 PLINTA (pour PLINT)



PLINT (en 1,50 ml), hauteur 10 cm

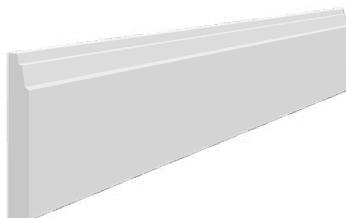

PLIN08M (en 1,50 ml), hauteur 8 cm  
 PLIN10M (en 1,50 ml), hauteur 10 cm



# LES COLONNES



40.06  
24 x 24 x H 11 cm  
40.60, 1/2 chapiteau



40.07  
24 x 24 x H 13 cm  
40.70, 1/2 chapiteau



40.03  
Ø 29,5 cm - H 13 cm  
40.30, 1/2 chapiteau



40.08  
29 x 29 x H 24 cm  
40.80, 1/2 chapiteau



40.09  
24 x 24 x H 8 cm  
40.90, 1/2 chapiteau



40.01  
46 x 46 x H 40 cm  
40.10, 1/2 chapiteau



40.04  
30 x 30 x H 10 cm  
40.40, 1/2 chapiteau



40.07A  
29 x 29 x H 13 cm  
40.70A, 1/2 chapiteau



20.05  
H 205 cm  
Ø haut 14 cm  
sous collerette  
Ø base / 19 cm

20.55  
1/2 col.  
H 205 cm

Socle :  
25 x 25 x 30 cm



20.04  
H 205 cm  
Ø haut 14 cm  
sous collerette  
Ø base / 19 cm

20.54  
1/2 col.  
H 205 cm

Socle :  
25 x 25 x 30 cm



20.02  
H 220 cm  
Ø haut 20 cm  
sous collerette  
Ø base / 26 cm

20.52  
1/2 col.  
H 220 cm

Socle :  
35 x 35 x 50 cm

*Les dimensions de nos fûts vous sont données hors socle.*



## Mise en oeuvre

- Pour habiller un poteau nos colonnes sont livrées par deux 1/2 colonnes à assembler
- L'ajustement de la colonne à la hauteur désirée se fait par réduction de la hauteur du socle ou encore de son fût.



40.02  
41 x 41 x H 16,5 cm  
40.20, 1/2 chapiteau



40.01  
46 x 46 x H 40 cm  
40.10, 1/2 chapiteau



40.05  
34 x 34 x H 10 cm  
40.50, 1/2 chapiteau

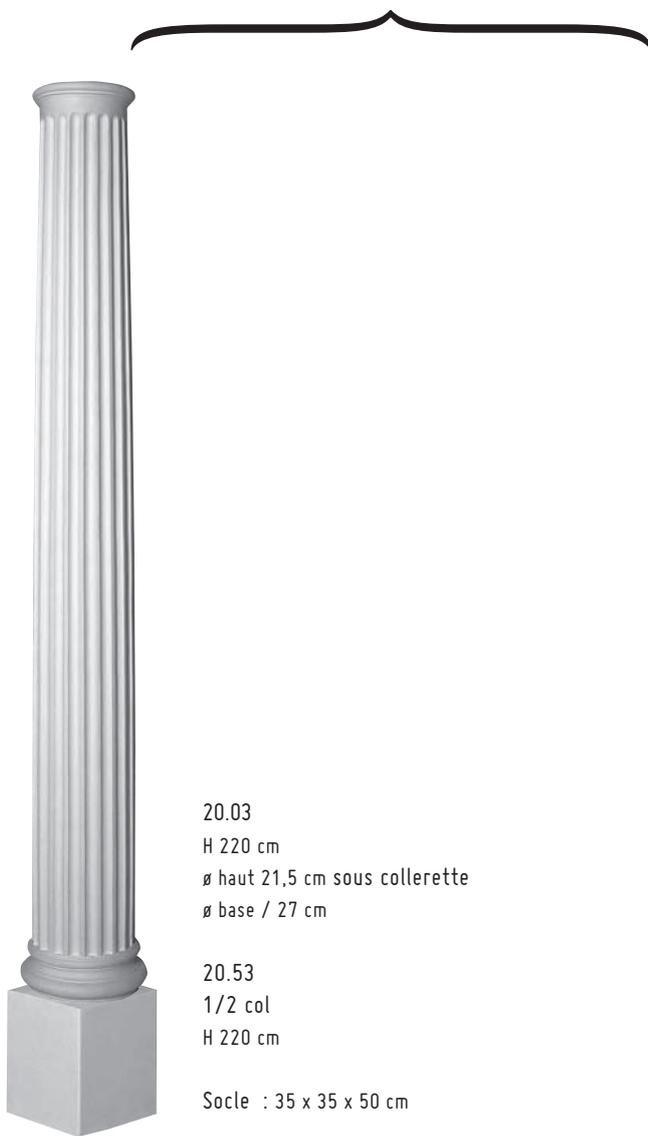

20.03  
H 220 cm  
ø haut 21,5 cm sous collerette  
ø base / 27 cm

20.53  
1/2 col  
H 220 cm

Socle : 35 x 35 x 50 cm



20.01  
H 220 cm  
ø 25 cm

20.51  
1/2 col.  
H 220 cm

Socle : 35 x 35 x 50 cm

*Les dimensions de nos fûts vous sont données hors socle.*

# Composez vos colonnes !

A l'aide de notre tableau de correspondances, choisissez les éléments qui s'adapteront à votre intérieur !

	DIAMETRE	DIMENSIONS colonne entière H x L x l	LISSES			HAUTEUR (en cm)	CANNELEES					
			½	ENTIERE			½	ENTIERE				
<b>CHAPITEAUX</b> 	Ø 15	11x24x24	40.60	40.06	<b>CHAPITEAUX</b> 		40.60	40.06				
	Ø 20	10x30x30	40.40	40.04			40.40	40.04				
	Ø 25	10x34x34	40.50	40.05			40.50	40.05				
	Ø 30	11,5x40x40	41.51	41.01			41.51	41.01				
	Ø 35	12,5x46x46	41.55	Nous consulter			41.55	Nous consulter				
	Ø 40	11x52x52	41.52	41.02			41.52	41.02				
	Ø 50	13x63x63	41.53	41.03			41.53	41.03				
<b>FÛTS LISSES</b> 	Ø 10	250	20.58	20.08	<b>FÛTS CANNELES</b> 	250	20.56	20.06				
	Ø 15	300	30.52	30.02		250	31.51	31.01				
	Ø 20	300	30.53	30.03		300	31.52	31.02				
	Ø 25	300	30.54	30.04		300	31.53	31.03				
	Ø 30	300	30.55	30.05		300	31.54	31.04				
	Ø 35	300	30.56	30.06		300	-	-				
	Ø 40	300	30.57	30.07		300	-	-				
	Ø 50	300	30.58	30.08		300	-	-				
	Ø 60	300	30.59	30.09		300	-	-				
	Ø 70	300	30.60	30.10		300	-	-				
	Ø 75	300	30.61	30.11		300	-	-				
	Ø 80	300	30.62	30.12		300	-	-				
	Ø 90	300	30.63	-		300	-	-				
<b>SOCLES &amp; COLLERETTES</b> 		DIM. ENTIER	COLLERETTE	SOCLE	COLLERETTE	SOCLE	<b>SOCLES &amp; COLLERETTES</b> 	Hauteur	COLLERETTE	SOCLE	COLLERETTE	SOCLE
	Ø 10	14,5x14x14	20.56B	20.56S	20.06B	20.06S		14,5	20.56B	20.56S	20.06B	20.06S
	Ø 15	39x25x25	45.51			45.01		39	45.51			45.01
	Ø 20	31x32x32	45.52			45.02		31	45.52			45.02
	Ø 25	61x35x35	45.53			45.03		61	45.53			45.03
	Ø 30	41x42x42	45.54			45.04		41	45.54			45.04
	Ø 35	Nous consulter	45.55			45.05		Nous consulter	45.55			45.05
	Ø 40		45.56			45.06			45.56			45.06
Ø 50		45.57			45.07		45.57			45.07		

Dimensions en cm



Les socles peuvent être coupés en hauteur.

# 10 showrooms en France pour répondre à vos besoins !

CAEN  
Z.I. EST - Rue de Bellevue  
14650 CARPIQUET  
Tél. 02 31 26 27 60  
Fax. 02 31 26 27 66  
email : ag14@staffdecor.fr

MANUFACTURE ET SIÈGE SOCIAL  
Z.A. de l'Hermitière, Route de Nantes  
35230 Orgères (Sud de Rennes)  
Tél. 02 99 42 30 30 - Fax (33) 02 99 42 36 36  
email : info@staffdecor.fr

STRASBOURG  
Z.I. - 22, rue des Tuileries  
67460 SOUFFELWEYERSHEIM  
Tél. 03 90 20 37 73  
Fax. 03 90 20 39 11  
email : ag67@staffdecor.fr

VANNES  
Z.I. du Prat - 23, rue du Général Baron Fabre  
56000 VANNES  
Tél. 02 97 54 25 55  
Fax. 02 97 54 00 11  
email : ag56@staffdecor.fr

PARIS  
ZAC du Plateau - 18, rue des Marronniers  
94240 L'HAY-LES-ROSES  
Tél. 01 48 52 73 23 - Fax. 01 48 52 52 46  
email : ag94@staffdecor.fr

TOURS  
Z.I. N°2 - 18, rue Etienne Cosson  
37170 CHAMBRAY LES TOURS  
Tél. 02 47 28 59 66  
Fax. 02 47 27 99 84  
email : ag37@staffdecor.fr

BORDEAUX  
170, cours Médoc - Galerie Tatry  
33000 BORDEAUX  
Tél. 05 56 29 09 65  
Fax. 05 56 29 09 67  
email : ag33@staffdecor.fr

LYON  
9, boulevard Lucien Sampaix  
69190 SAINT-FONS  
Tél. 04 78 67 17 17  
Fax. 04 78 67 18 18  
email : ag69@staffdecor.fr

MARSEILLE  
240, av. de Coullins - P. d'activité  
13420 GEMENOS  
Tél. 04 42 32 32 11

NICE  
27, boulevard de Riquier  
06300 NICE  
Tél. 04 93 89 77 82  
Fax. 04 93 89 77 94  
email : ag60@staffdecor.fr



TRAX-MATTHIES / STAFF DECOR  
Schwarzer Weg 5 | 22309 Hamburg  
Öffnungszeiten: Mo - Fr. 9.00 - 15.00  
Fon. +49 (0) 40 630 70 26  
Mail. info@stuckhandel.de

# stuckhandel.de