

A-A' SECTION 1/50

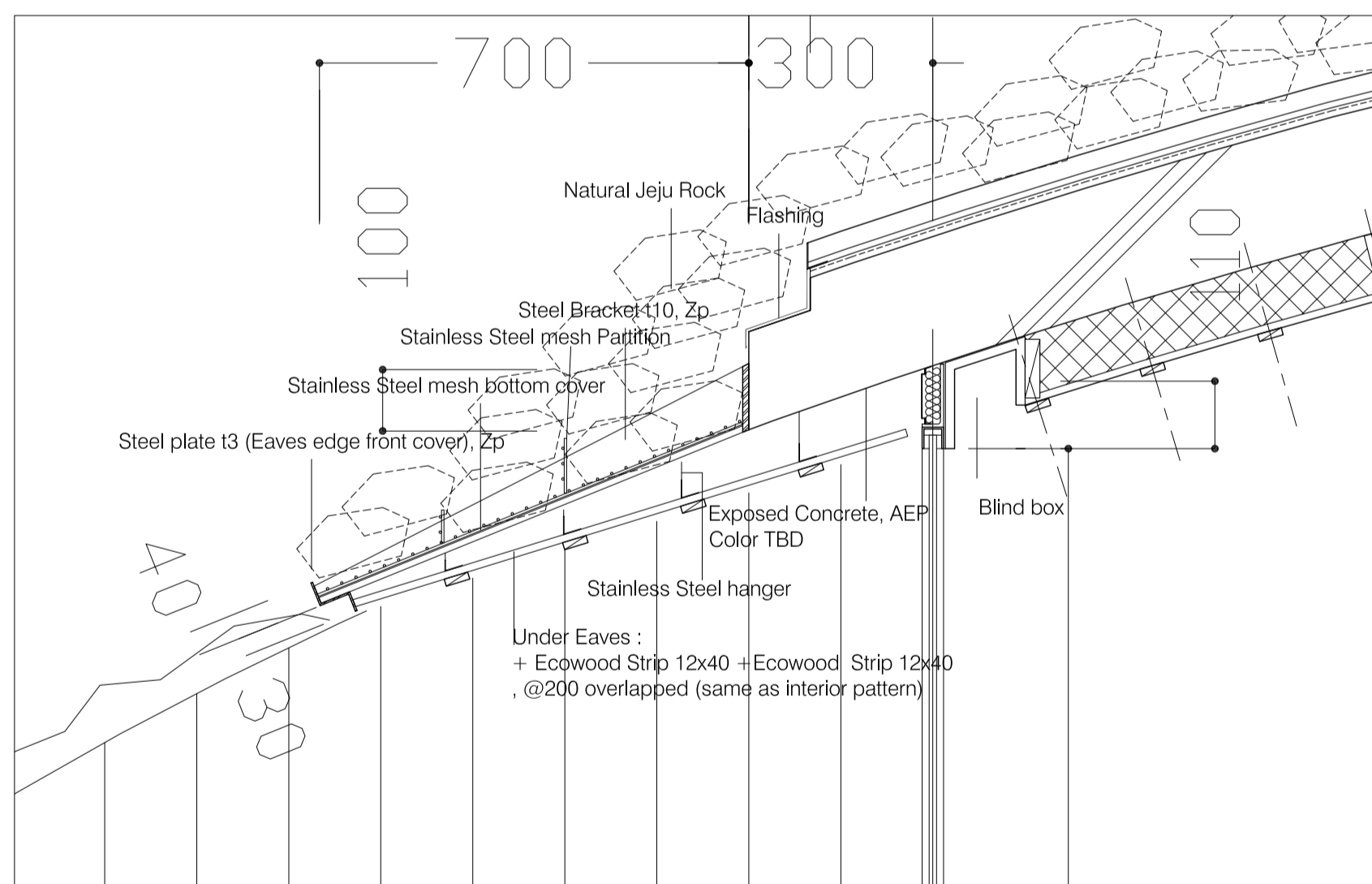

A-03 detail 1/10

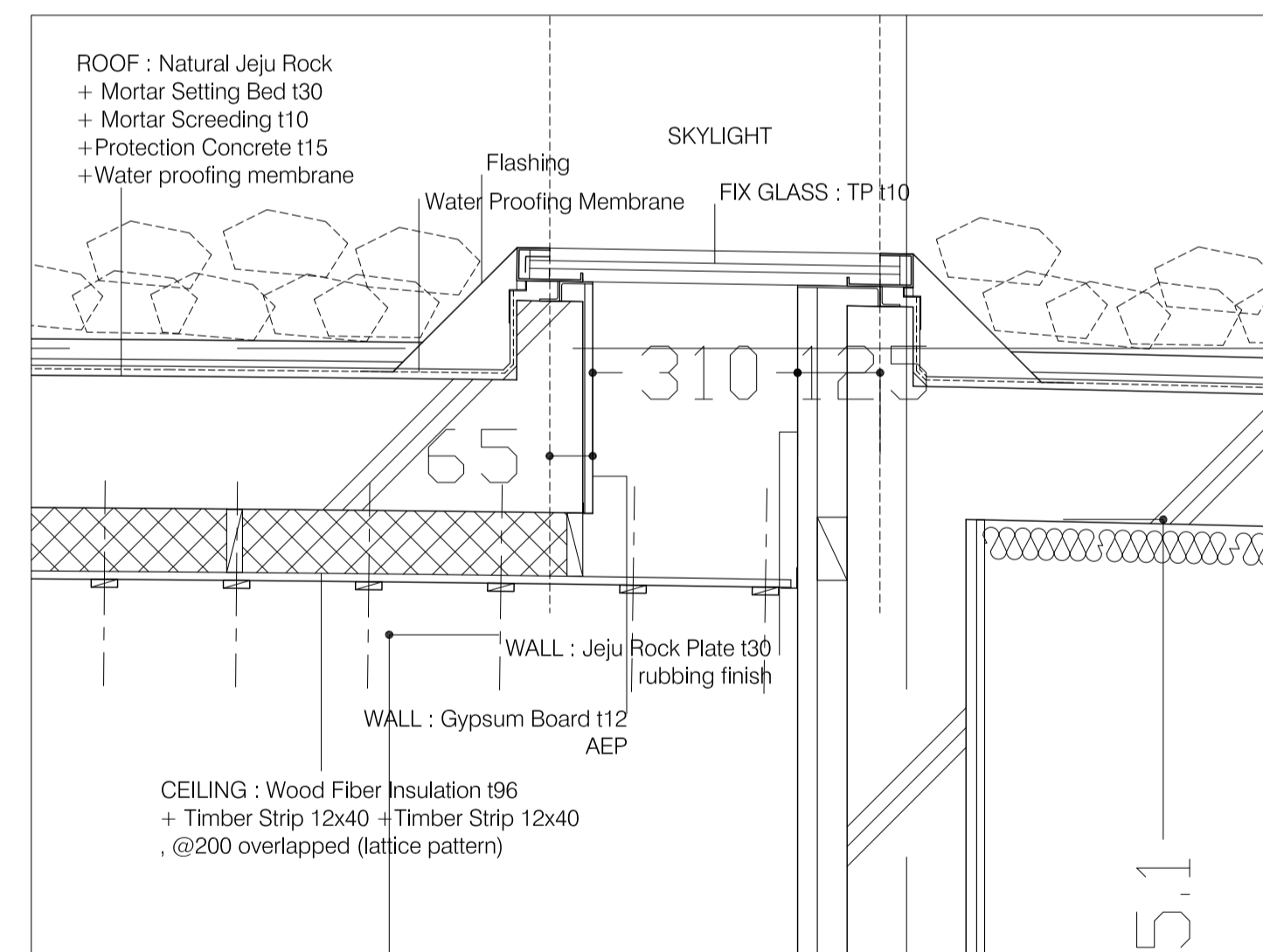

A-06 detail 1/10

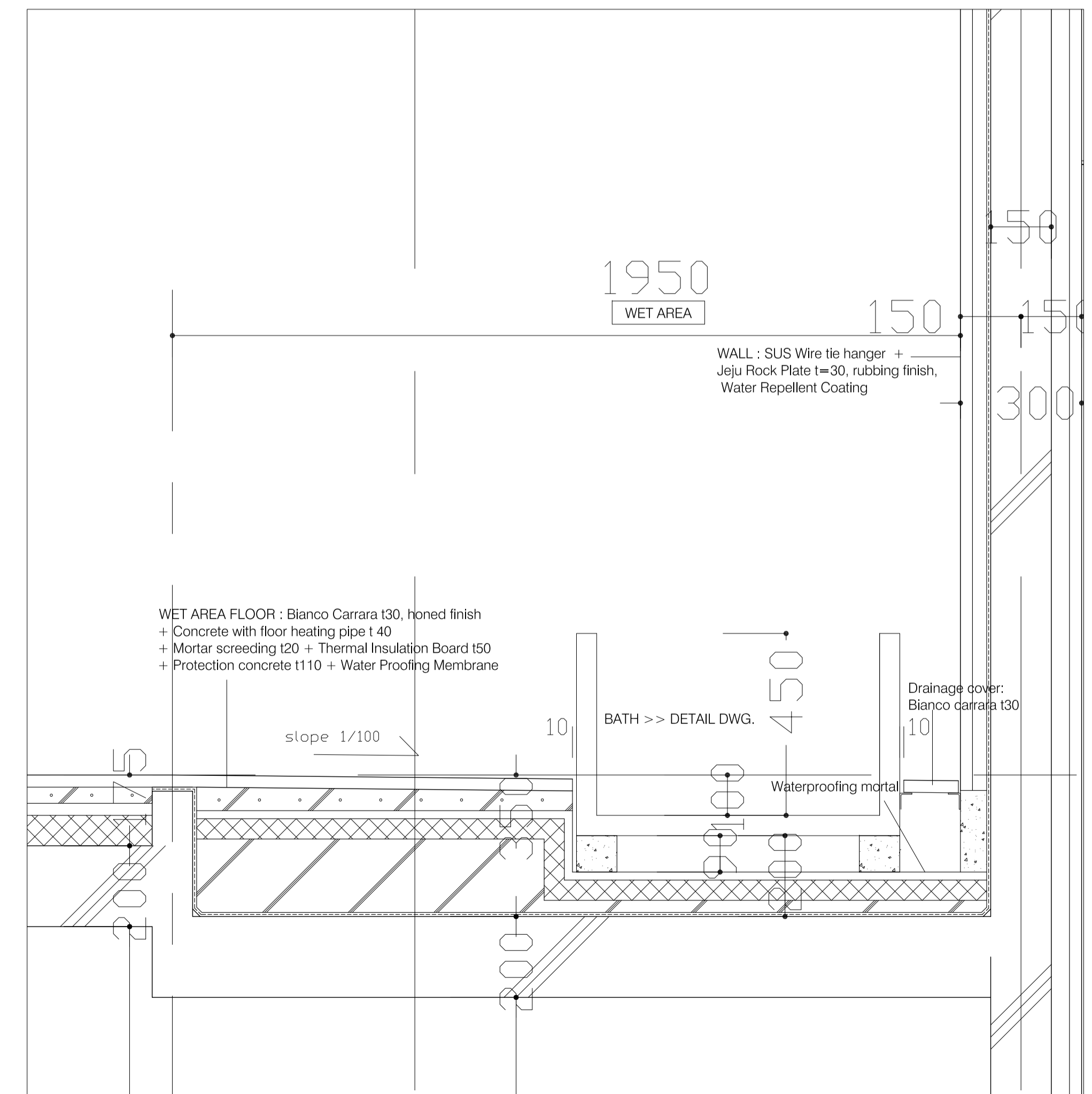

A-07 detail 1/10

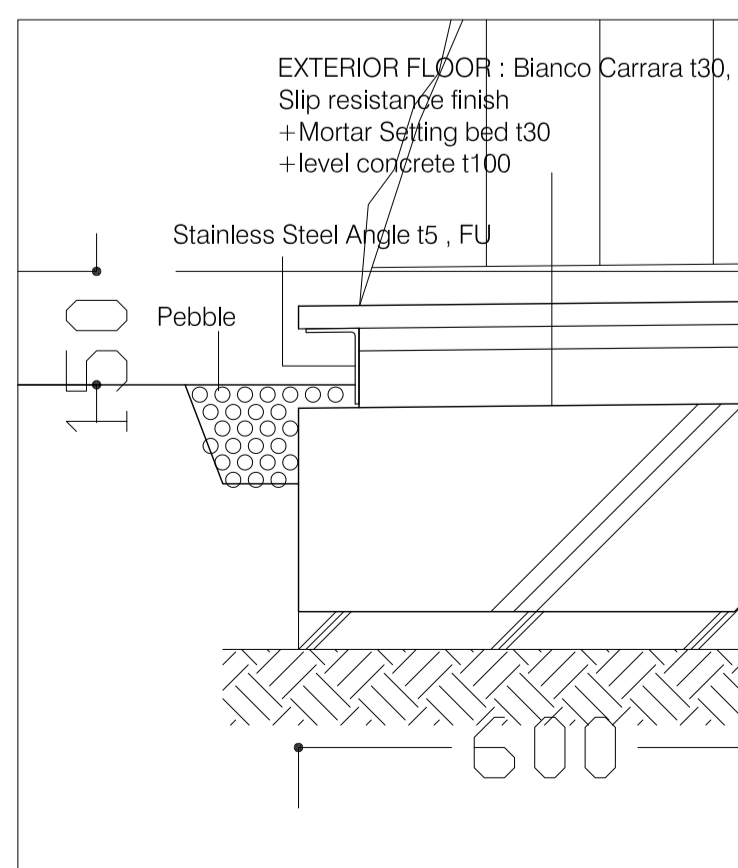

A-01 detail 1/10

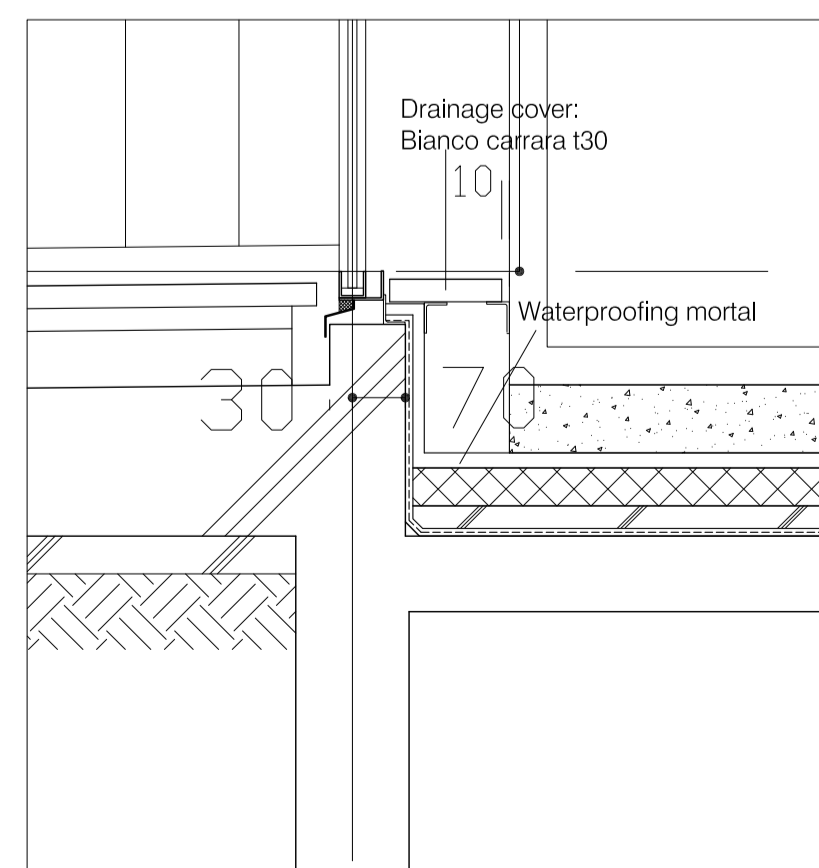

A-02 detail 1/10

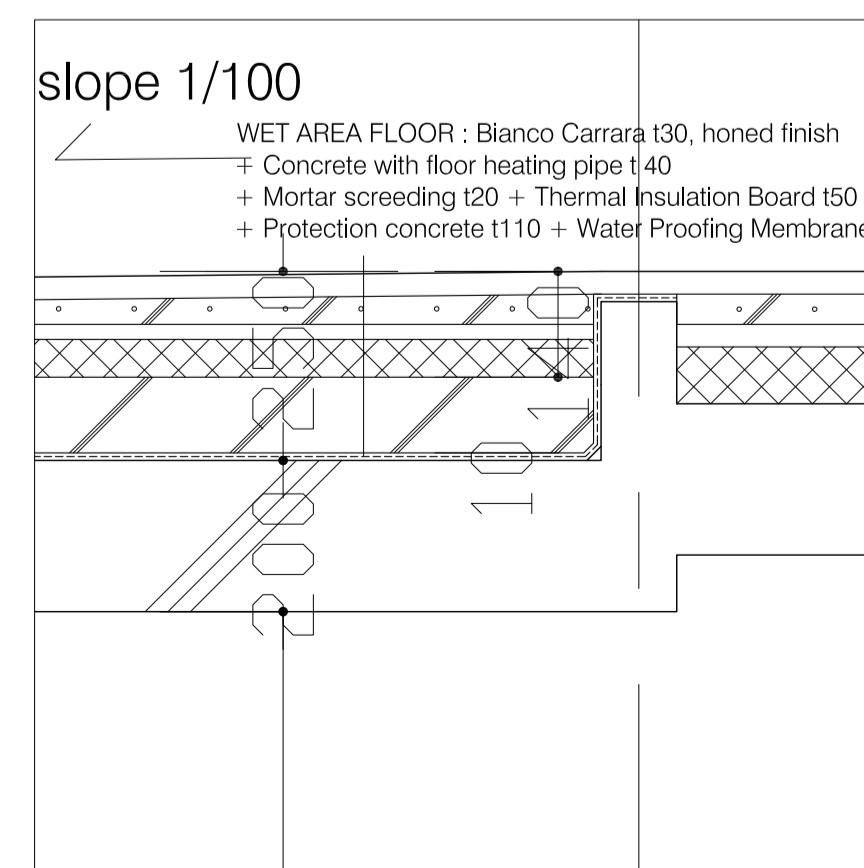

A-04 detail 1/10

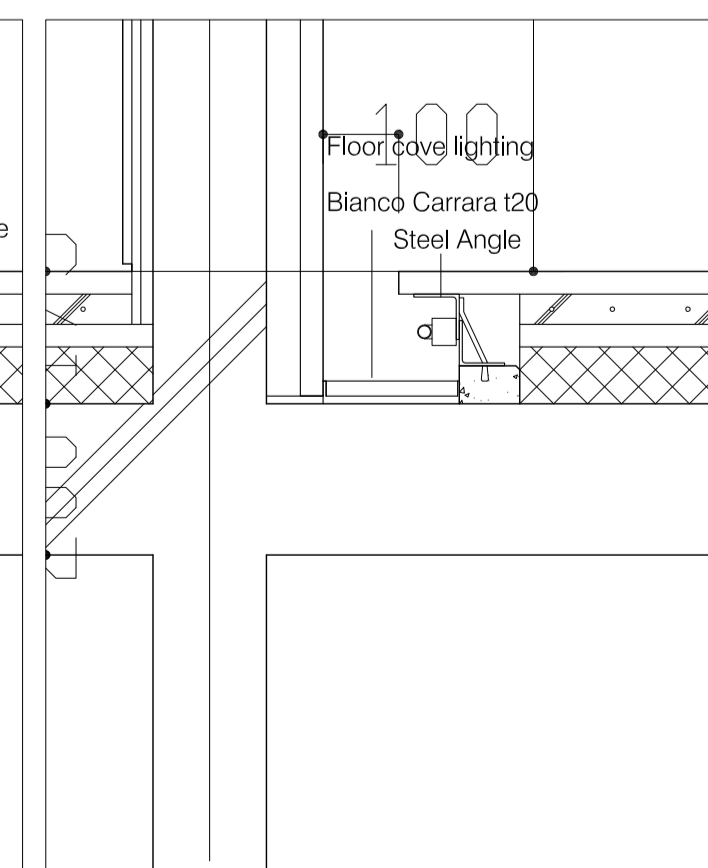

A-05 detail 1/10



