

1200

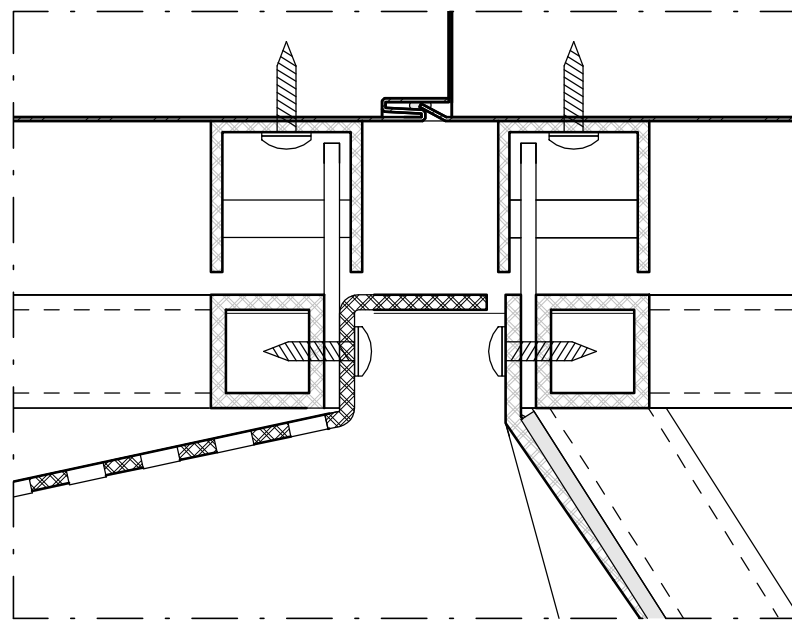

DT01  
1:2

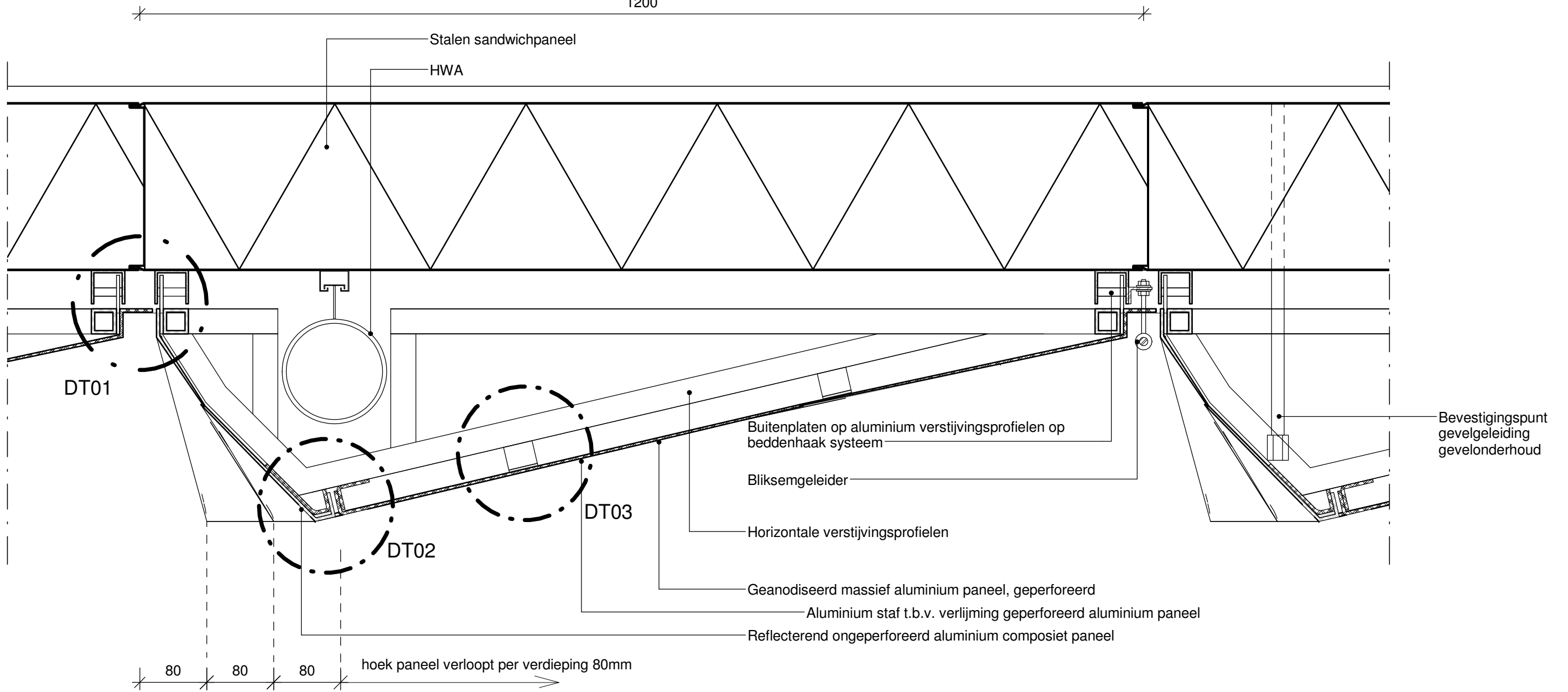
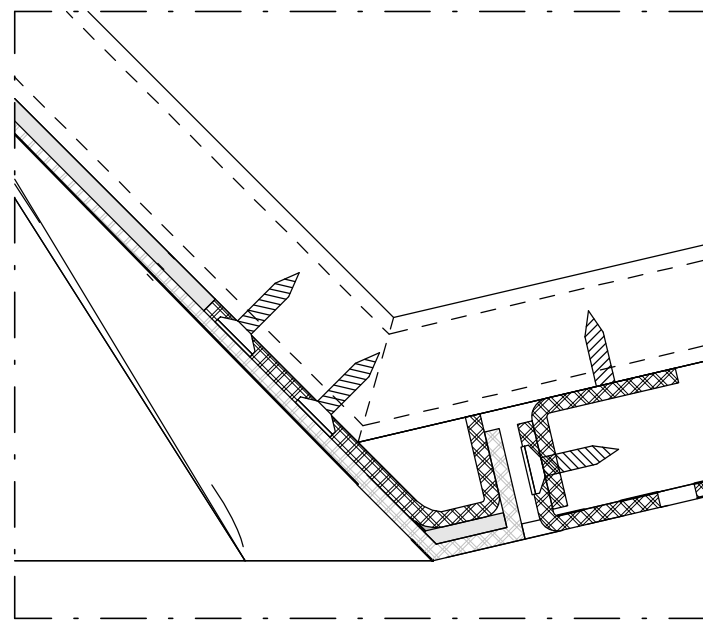

DT02  
1:2

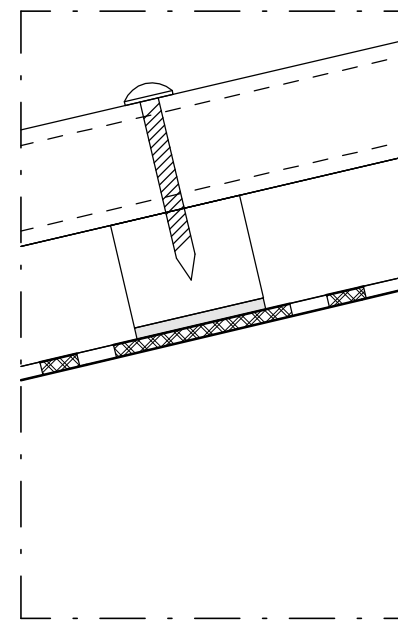

DT03  
1:2

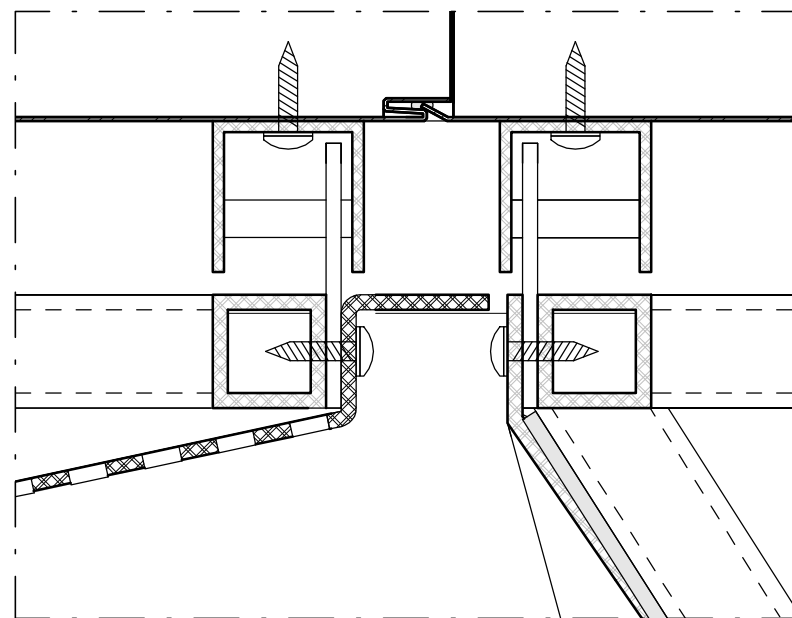
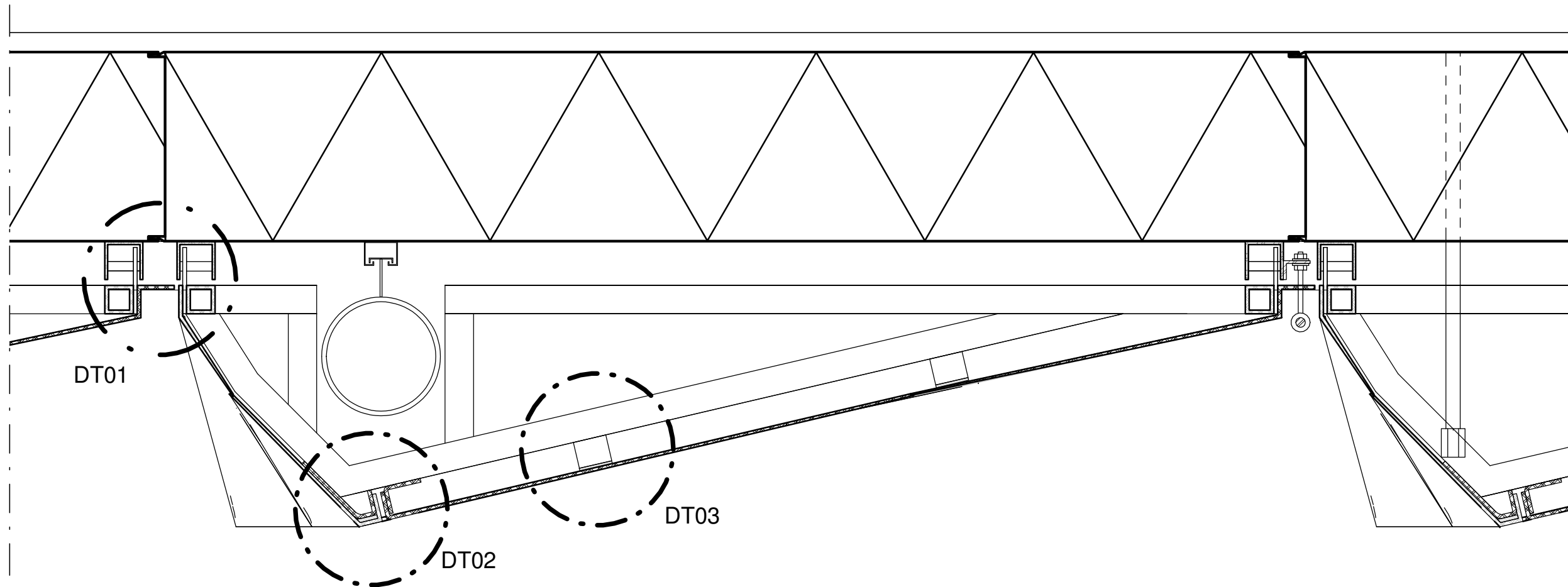

DT01  
1:2

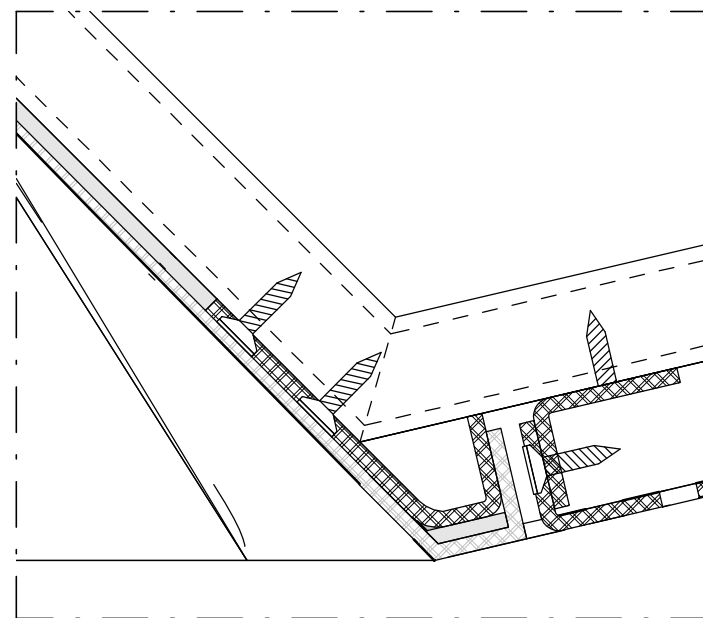

DT02  
1:2

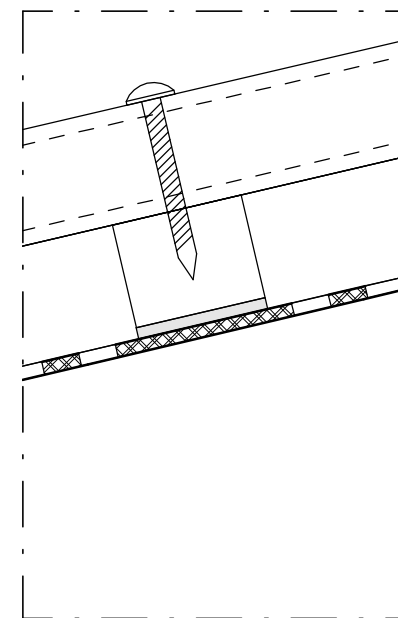

DT03  
1:2