

# INNENSTUCK KATALOG 2021/22

Stuck aus:  
Naturgips /  
Alabaster-Modellgips,  
glasfaserverstärkt,  
unbehandelt,  
Baustoffklasse  
A1, nicht brennbar.



[stuckhandel.de](https://stuckhandel.de)

# SOMMAIRE

<b>NOUVEAUTÉS</b>	<b>8</b>
<b>LE PLAFOND</b>	<b>12</b>
LES CORNICHES	16
LES MOULURES	38
LES ANGLES & DOUCINES DE MOULURES	44
LES ROSACES & CAISSONS DE PLAFOND	48
LA COLLECTION ORIENTALE	66
<b>LES MURS</b>	<b>70</b>
LES PANNEAUX 3D & PAREMENTS	74
L'HABILLAGE MURAL PAR LAMBRISSAGE	96
LES HABILLAGES DE PORTE	104
LES FRONTONS	106
LES COLONNES & LES PILASTRES	108
<b>LES AGENCEMENTS &amp; MOBILIER</b>	<b>118</b>
LES MODULOSTAFF & NICHES	120
LES TÊTES DE LIT	128
LES MEUBLES EN STAFF	130
LES PASSAGES & MEUBLES DE PASSAGE	136
LES CACHE-RADIATEURS	144
<b>LES CHEMINÉES</b>	<b>150</b>
<b>LES LUMINAIRES</b>	<b>154</b>
<b>LES PRODUITS TECHNIQUES</b>	<b>160</b>

# GAMME VARIANCE

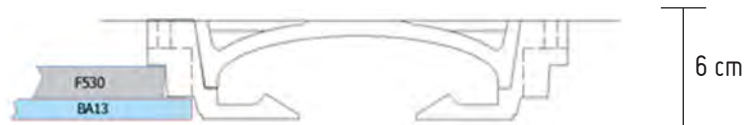
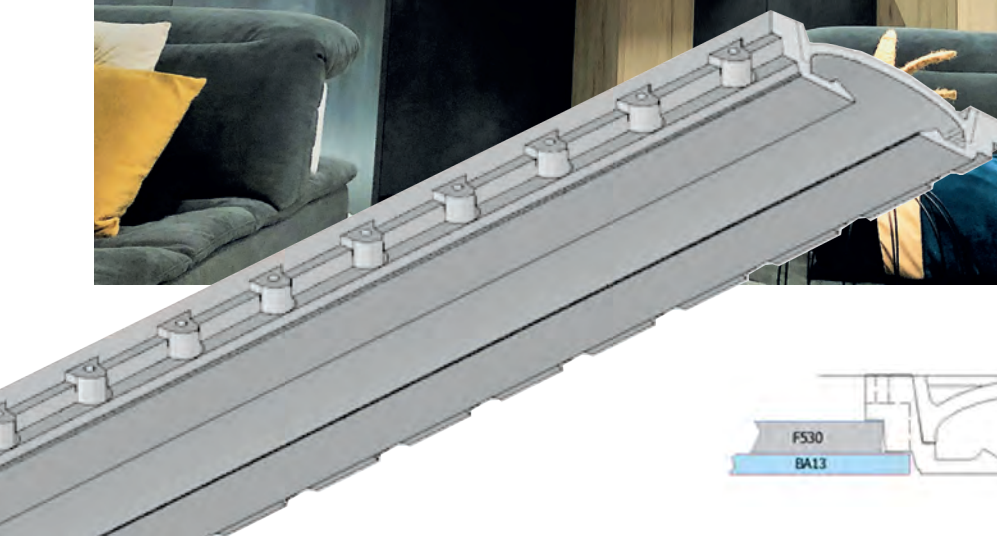

Depuis déjà plus de 10 ans, Staff Décor travaille sur l'éclairage indirect et toutes ses déclinaisons pour les murs et plafonds. Variance, notre nouvelle gamme est née de notre volonté de rendre simple et confortable la pose de nos produits. Sa mise en œuvre sans contraintes techniques, au mur ou au plafond, amène une subtilité de diffusion de l'éclairage inédite. Son principe est d'associer facilement la liaison entre les ossatures (type F530) et plaques de plâtre (13 mm).



## Avantages

- > Un nouveau système de pose simple et rapide, sa forme est spécialement étudiée pour une mise en place simplifiée.
- > Gamme évolutive permettant des solutions de décoration novatrices.
- > Design apportant finesse et élégance.
- > Eclairage indirect discret. Pas de nécessité de mettre systématiquement 2 rubans Led.



## Cas d'utilisation

- > **Neuf** : sur structure béton avant mise en œuvre des plaques de plâtre...
- > **Rénovation** : Création des volumes / reprise de plafond fissuré / intégration un plénum technique ...
- > **Agencement**.

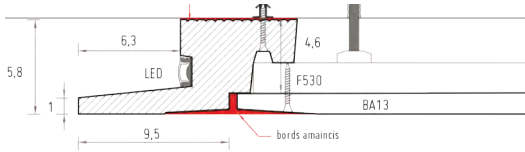
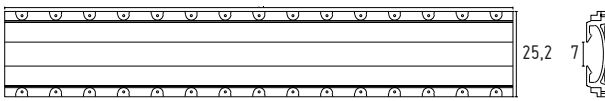
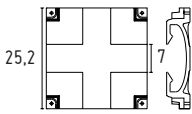
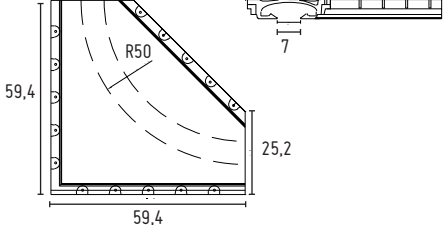
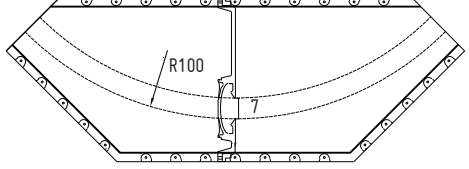
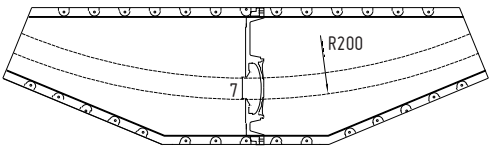
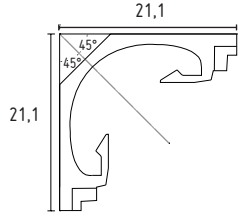
<p>D110 Profil pour création d'éclairage périphérique</p> <p>Utilisation mur et plafond</p> <p>Longueur 200 cm</p> <p>Hauteur 5,8 cm</p> <p>Largeur 13,5 cm</p>	
<p>X.L150 Élément droit double gorge</p> <p>Utilisation mur et plafond</p> <p>Longueur 150 cm</p> <p>Hauteur 6 cm</p> <p>Largeur 25,2 cm</p>	
<p>X.C090 Élément de raccord permettant la jonction de profil droit ou courbe</p> <p>Utilisation mur et plafond</p> <p>Longueur 25,2 cm</p> <p>Hauteur 6 cm</p> <p>Largeur 25,2 cm</p>	
<p>X.R050 Élément arrondi rayon de 50 cm</p> <p>Utilisation mur et plafond</p> <p>Longueur 81,2 cm</p> <p>Hauteur 6 cm</p> <p>Largeur 59,4 cm</p>	
<p>X.R100 Élément arrondi rayon de 100 cm</p> <p>Utilisation mur et plafond</p> <p>Longueur 156,6 cm</p> <p>Hauteur 6 cm</p> <p>Largeur 55 cm</p> <p>1/4 de cercle</p>	
<p>X.R200 Élément arrondi rayon de 200 cm</p> <p>Utilisation mur et plafond</p> <p>Longueur 160,7 cm</p> <p>Hauteur 6 cm</p> <p>Largeur 38,5 cm</p> <p>1/8 de cercle</p>	
<p>X.D150 Corniche « inversée »: Trou de lumière en lieu et place de la corniche</p> <p>Utilisation mur et plafond</p> <p>Longueur 150 cm</p> <p>Hauteur 6 cm</p> <p>Largeur 21,1 cm</p>	

1268 (en 1,82 ml)  
FRISE TAJ MAHAL  
27,2 cm de largeur



M423  
ROSACE  
89 x 89 cm



D632 & D633 (en 2ml)  
Corniche  
20 x 20 cm  
30 x 30 cm



D903 (en 2 ml)  
Corniche  
32 x 21 cm



M401P  
120 x 120 cm  
Stratistaff



DÉCLINAISON  
DE LA ROSACE  
M401 POUR UN  
ENCASTREMENT  
OPTIMAL !



M604

> Rosace Ø 162 cm  
Stratistaff

D658 (en 2 ml)  
Corniche  
19 x 38 cm



PL319  
Plafonnier



180 cm

80,5 cm

80,5 cm

81,2 cm

100 cm



D110  
PAGE 26

ROND LUMINEUX SUR-MESURE



ÉCOINÇON D880A  
PAGE 32

CORNICHE D880  
PAGE 32

ROSACE M405  
PAGE 57

# LE PLAFOND



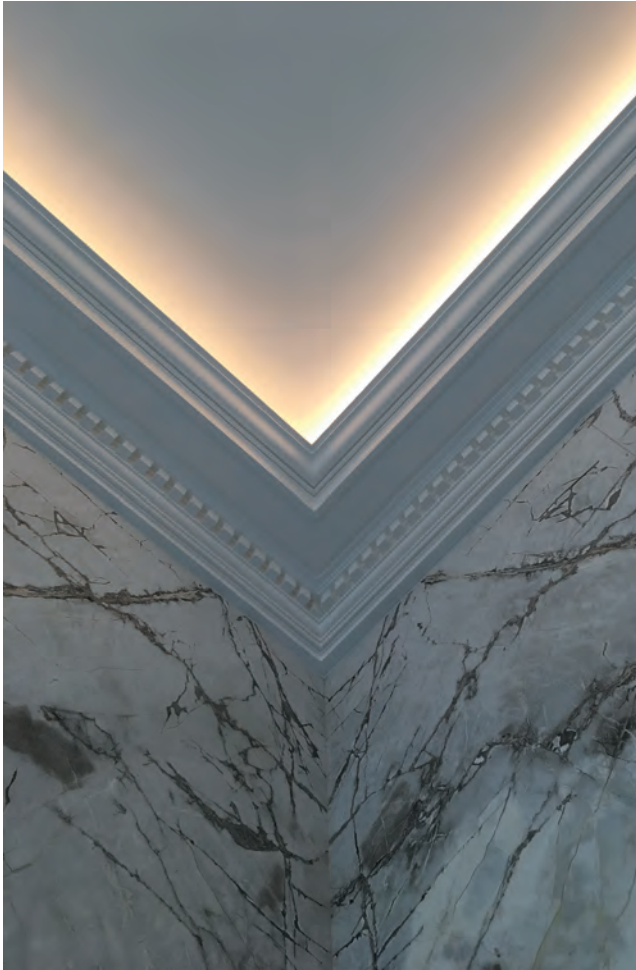

	<b>LES CORNICHES</b>	<b>16</b>
	LES CORNICHES CONTEMPORAINES	18
	LES CORNICHES À ÉCLAIRAGE INDIRECT	24
	LES CORNICHES CLASSIQUES	30
	LES CORNICHES ORNEMENTÉES	34
	<b>LES MOULURES</b>	<b>38</b>
	LES MOULURES LISSES	40
	LES MOULURES ORNEMENTÉES	42
	<b>LES ANGLES &amp; DOUCINES DE MOULURES</b>	<b>44</b>
	LES MOULURES & ANGLES DE MOULURES	46
	LES DOUCINES	47
	LES ANGELOTS	47
	<b>LES ROSACES &amp; LES CAISSONS DE PLAFOND</b>	<b>48</b>
	LES ROSETTES	50
	LES ROSACES ORNEMENTÉES	51
	LES ROSACES LISSES	63
	LES CAISSONS DE PLAFOND	64
	<b>LA COLLECTION ORIENTALE</b>	<b>66</b>
	LES MOULURES & FRISES	68
	LES ABAT-JOUR	68
	LES ROSACES	69
	LES FRONTONS & CHAPITEAUX	69



CORNICHES D105A ET D105B  
PAGE 25  
RBE

# LES CORNICHES

CORNICHE D716  
PAGE 36



CORNICHES CONTEMPORAINES

D568 (en 2 ml)

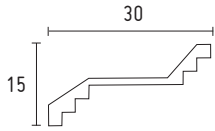

D891 (en 2 ml)

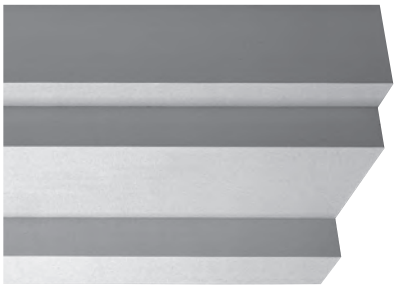
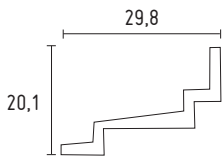

D564 (en 2 ml)

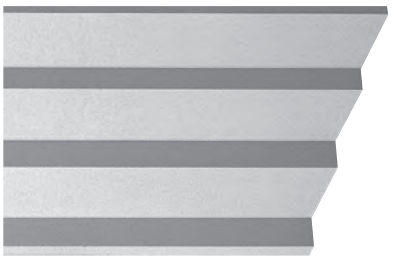
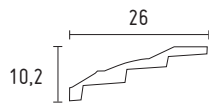

D567 (en 2 ml)

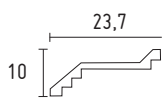

CORNICHE D575  
en 2 ml page 19

D577 (en 2 ml)

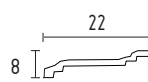

D579 (en 2 ml)

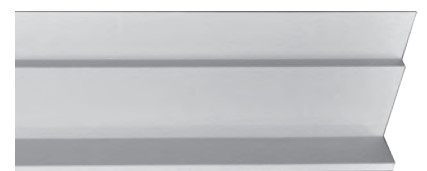

D901 (en 2 ml)

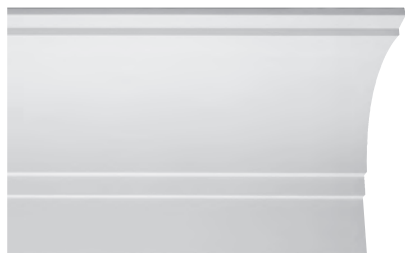
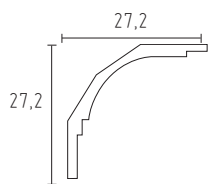

D576 (en 2 ml)



D563 (en 2 ml)



D565 (en 2 ml)



D580 (en 2 ml)

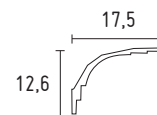

D720 (en 2 ml)

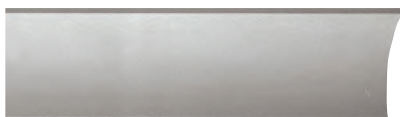
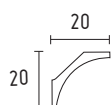

D562 (en 2 ml)

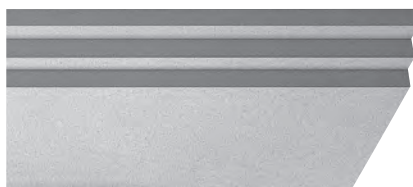
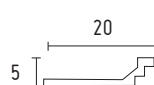

D575 (en 2 ml)



D718 (en 2 ml)

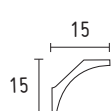

D578 (en 2 ml)

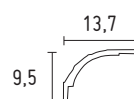

D620 (en 2 ml)

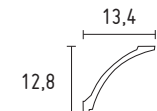

D631 (en 2 ml)

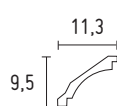

D621 (en 2 ml)

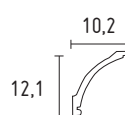

D705 (en 2 ml)

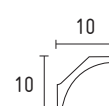

D706 (en 2 ml)

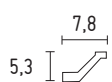

D561 (en 2 ml)

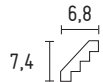

D555 (en 1,50 ml)





POSÉE EN PÉRIPHÉRIE DE LA PIÈCE,  
LA DEMI-VAGUE SERPENTE LE LONG DES  
PLAFONDS POUR EN ADOUCIR LES ANGLES.

## VAGUE DE SÉPARATION avec corniche D577 intégrée

Ce décor de plafond préfabriqué monobloc en forme permet de créer au sein d'une grande pièce deux espaces distincts. Par exemple, il assurera la séparation entre le coin séjour et le coin salon.

- > Largeur avec corniche : 104 cm
  - > Largeur de la plage : 60 cm
  - > Longueur sur mesure (possibilité jusqu'à 6 mètres, livrés en plusieurs éléments si nécessaire en fonction des contraintes d'accessibilité)
  - > La retombée de 8 cm permet de repenser l'éclairage de la pièce par l'installation de spots.
- Il est préférable de réaliser les trous de réservation pour les spots lors de la fabrication de l'élément.



Face intérieure du moulage faisant apparaître les renforts métalliques de type F530 qui pourront être utilisés pour la fixation au plafond de la vague.

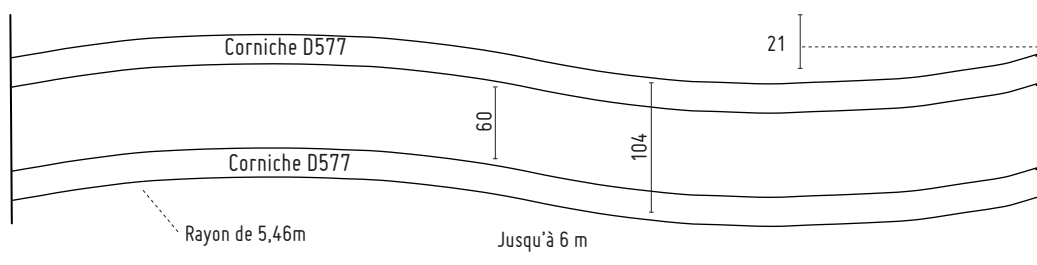
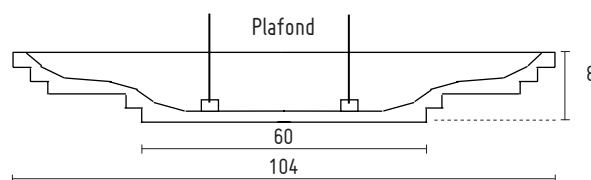

## CORNICHE EN VAGUE

Ce décor de plafond associe sur un même moulage une plage horizontale d'une largeur variable jusqu'à 67 cm pour la référence SV577 et 83 cm pour la SV748 et une corniche dont les ondulations régulières forment des vagues qui se propagent le long des murs.

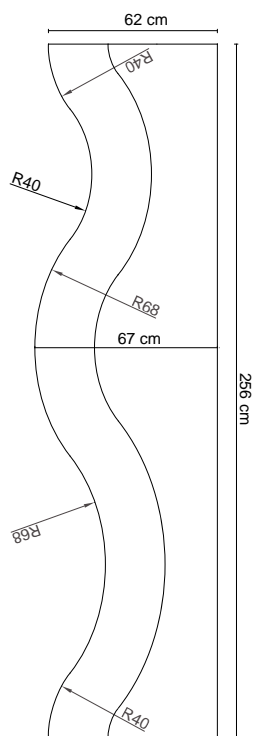

POSÉE DIRECTEMENT AU PLAFOND, LA VAGUE RÉF. SV577 PERMET D'INTÉGRER UN ÉCLAIRAGE PAR SPOTS DE LA PIÈCE.

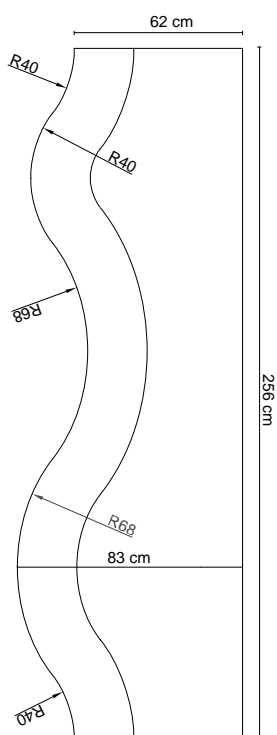

POSÉE À 10 CM ENVIRON DU PLAFOND, LA CORNICHE EN VAGUE RÉF. SV748 CONSTITUE ÉGALEMENT LE SUPPORT ORIGINAL D'UN ÉCLAIRAGE INDIRECT.



## LA CORNICHE S908

Le profil de cette corniche peut être fabriqué en un seul élément présentant une avancée sur le plafond de 90 cm et une longueur pouvant atteindre 290 cm. La réalisation de ce décor de plafond en staff traditionnel aurait conduit à poser, assembler et jointoyer sur le chantier deux corniches distinctes reliées entre elles par une plage horizontale de 51 cm en staff ou en plaque de plâtre. Ce profil S908 est fixé mécaniquement par vissage sur ossatures fixées sur le mur et sur le plafond, ce qui simplifie la mise en œuvre et en réduit substantiellement les délais d'exécution.

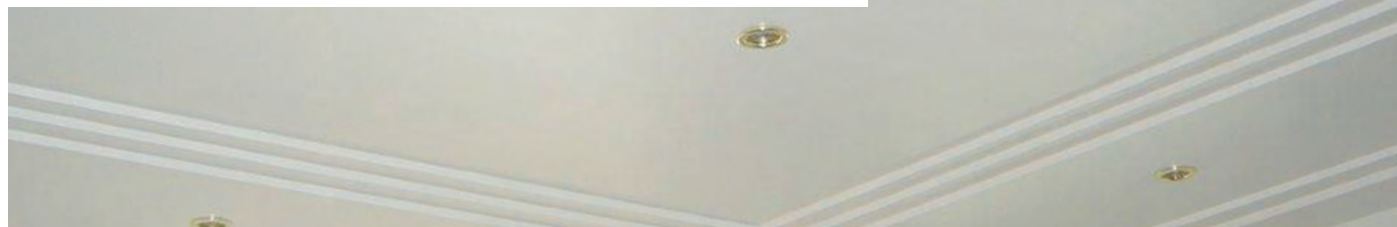

Pour composer ce plafond, il vous faudra intégrer deux éléments distincts :

> L'élément d'angle Réf S908A

> L'élément de côté Réf S908

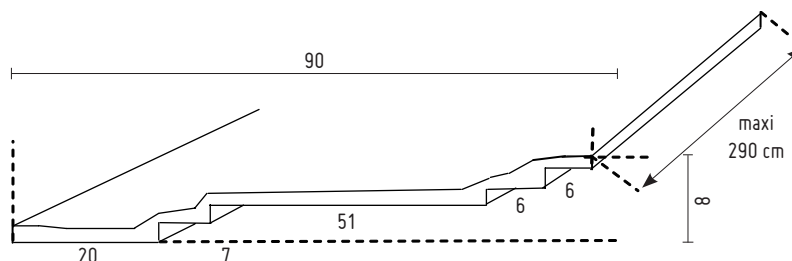
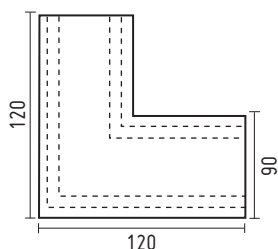

Les éléments de côté sont fabriqués selon un plan de calepinage établi sur la base des dimensions du plafond.  
Le poids de cet ensemble sera d'environ 9 à 10 kg/m<sup>2</sup>.

### LES AVANTAGES

- > Installation très rapide, les éléments s'emboîtent les uns dans les autres.
- > Conservation de la hauteur sous-plafond.
- > Possibilité d'installer un éclairage direct ou indirect.
- > Les moulages sont préparés pour faciliter leur montage.

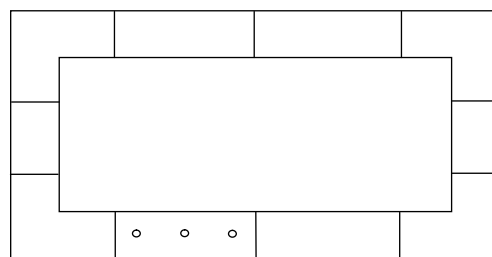

### Mise en œuvre simple par vissage

> Montage classique avec spot

> Montage en éclairage indirect (équerre en supplément)

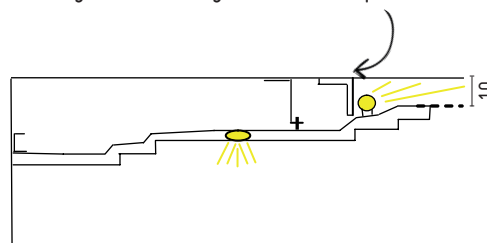
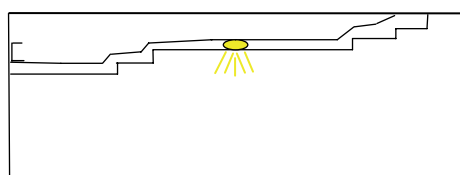

## DÉCORS DE PLAFOND EN «U»

Ce décor de plafond tout en sobriété est composé d'éléments en forme de «U» et de 2 ml de long. Disponible en 2 hauteurs (7 cm ou 10 cm) selon l'encombrement des luminaires à intégrer dans la partie centrale surépaissie. Il est mis en oeuvre par simple vissage sur tasseaux. Ces décors sont réalisés en Stratistaff (staff aminci). Vous pouvez retrouver l'ensemble de nos profils "U" en staff traditionnel à la page 160.

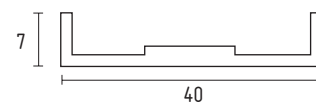

Réf. US0740 (en 2,50 ml)

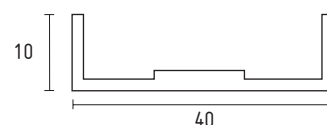

Réf. US1040 (en 2,50 ml)

Montée en soffite, cet élément décoratif redessine les espaces et permet l'installation de nouveaux éclairages tout en dissimulant le passage des gaines électriques.

## JOINTS CREUX

Les joints creux sont fournis en longueur de 2 ml.

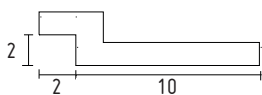

JC22.10

Joint creux 2 + 2 + 10 cm, ep. 1,5 cm

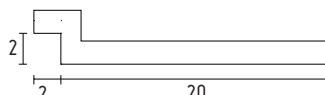

JC22.20

Joint creux 2 + 2 + 20 cm, ep. 1,5 cm

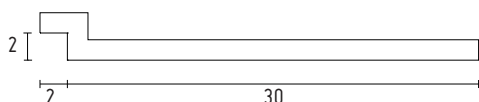

JC22.30

Joint creux 2 + 2 + 30 cm, ep. 1,5 cm

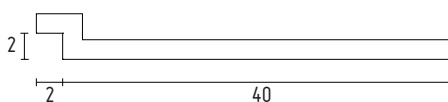

JC22.40

Joint creux 2 + 2 + 40 cm, ep. 1,5 cm

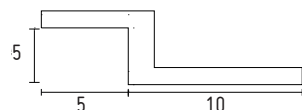

JC55.10

Joint creux 5 + 5 + 10 cm, ep. 1,5 cm

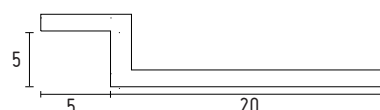

JC55.20

Joint creux 5 + 5 + 20 cm, ep. 1,5 cm



# CORNICHES À ÉCLAIRAGE INDIRECT

D708 (en 2 ml)

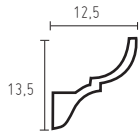

D749 (en 2 ml)

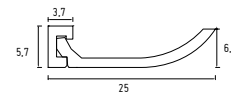

D709 (en 2 ml)

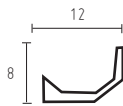

SDPA1 (en 1.20 ml)  
Vendus en carton de 2

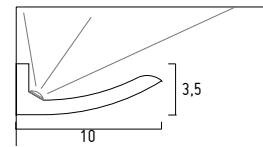

SCHEMA DE PRINCIPE D709

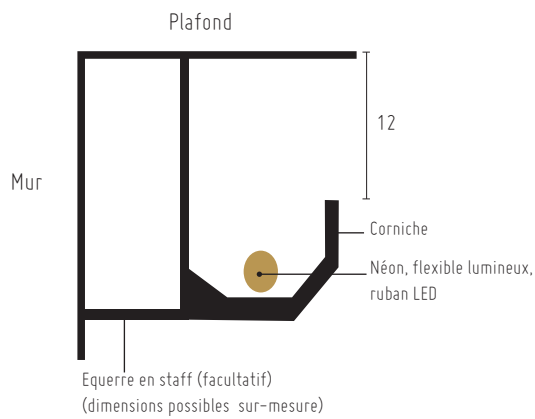

SDPA2 (en 1.20 ml)  
Vendus en carton de 2

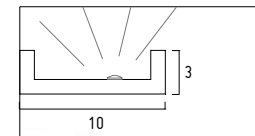

D710 (en 2 ml)



SDPA3 (en 1.20 ml)  
Vendus en carton de 2

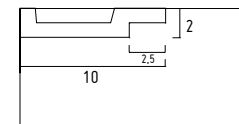

D748 (en 2 ml)

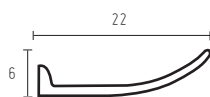

SDPA4 (en 1.20 ml)  
Vendus en carton de 2

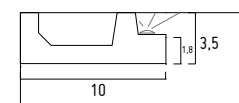

D101 (en 2 ml)

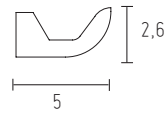

D102 (en 2 ml)

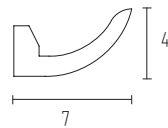

D103 (en 2 ml)

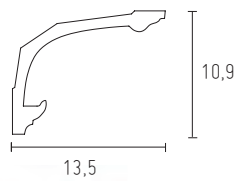

D104 (en 2 ml)

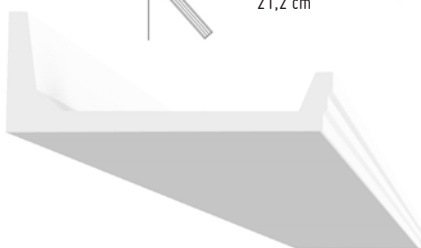
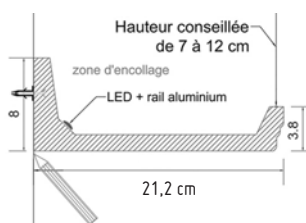

D105 A & B (en 2 ml)

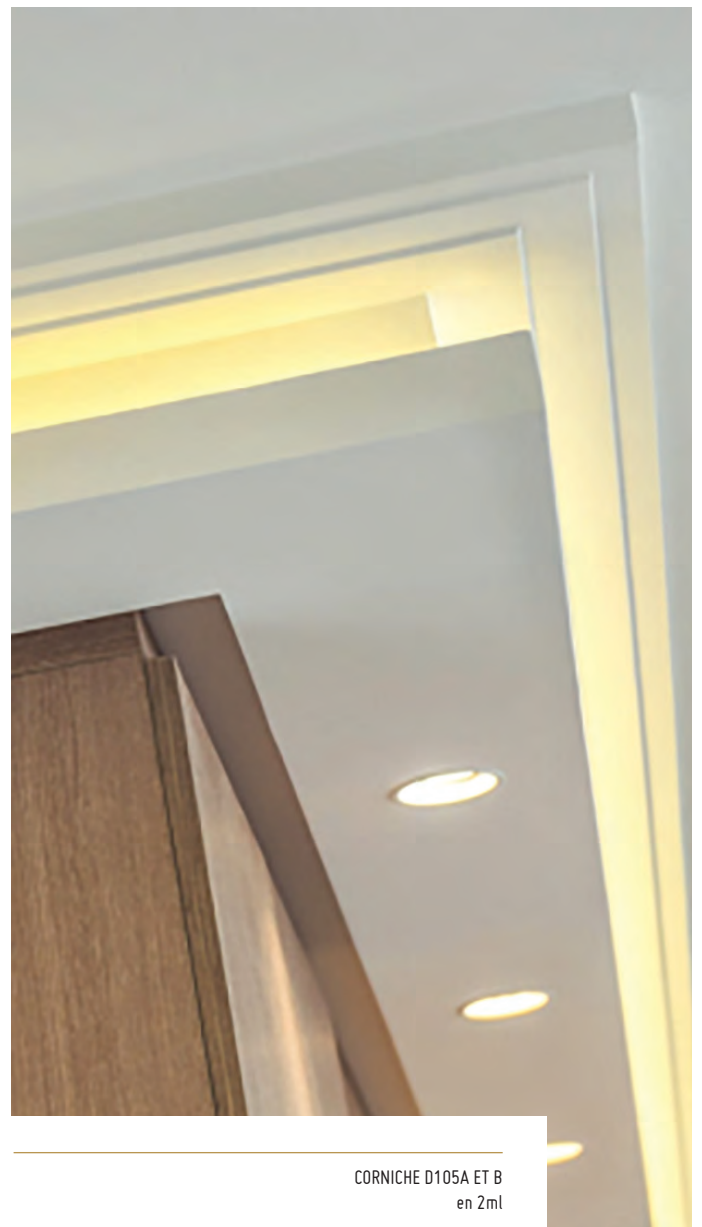
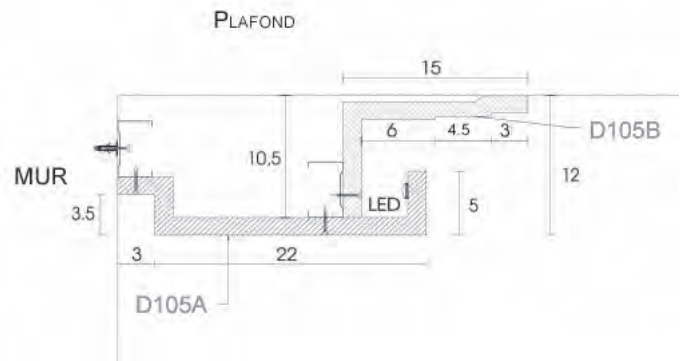

CORNICHE D105A ET B en 2ml

# CORNICHES À ÉCLAIRAGE INDIRECT

D106 (en 2 ml)

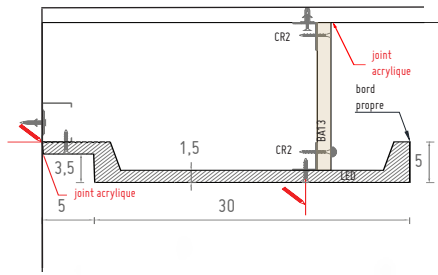

D107 (en 2 ml)

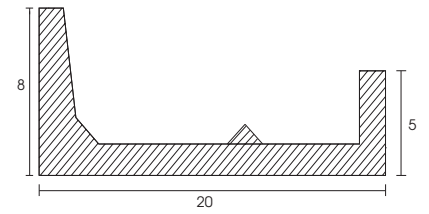

D108 (en 2 ml)

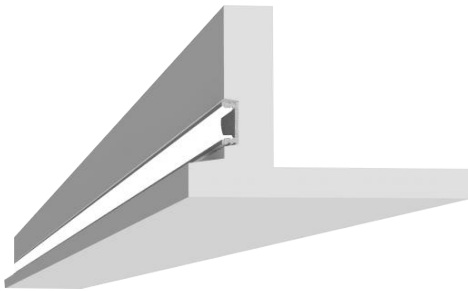
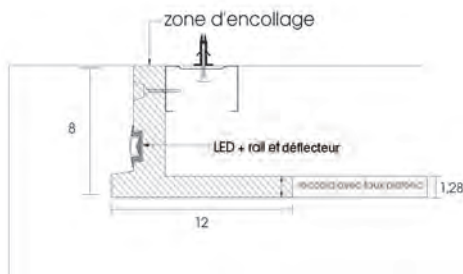

D110 (en 2 ml)

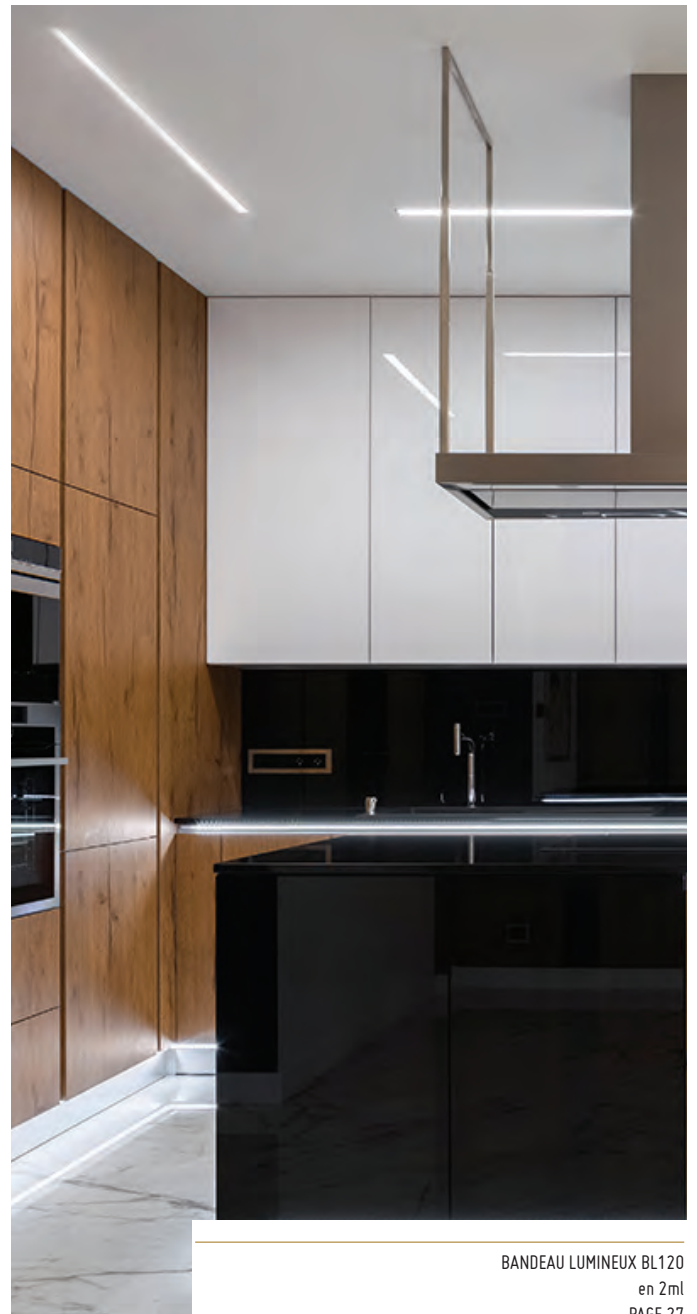
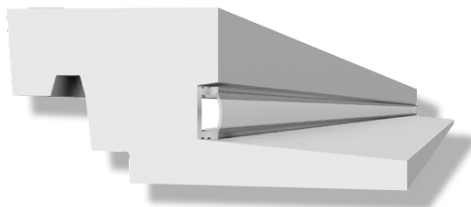
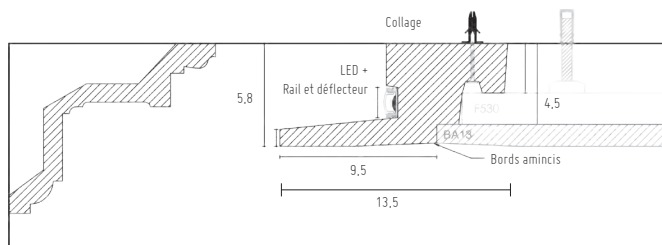

BANDEAU LUMINEUX BL120  
en 2ml  
PAGE 27

## PROFILS LUMINEUX COMPOSABLES

EMB95 (en 2 ml) > 9,7 x 4 cm  
 EBL0430 (en 2 ml) > 30 x 4 cm

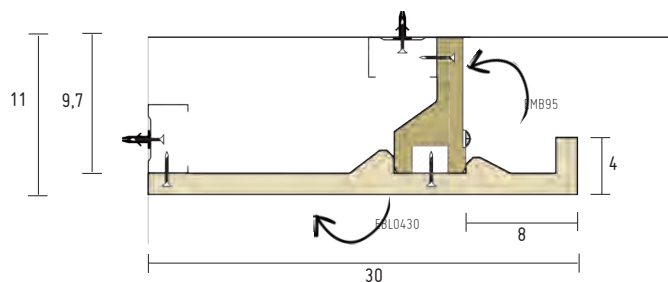

## BANDEAUX LUMINEUX COMPOSABLES

Les bandeaux lumineux sont des profils pouvant se poser en relief ou à fleur de vos murs et plafonds.

BL120 (en 2 ml)

Profil à associer à un rail en aluminium avec déflecteur en polycarbonate et un flexible LED.

12 x 2,5 cm | en 2 ml

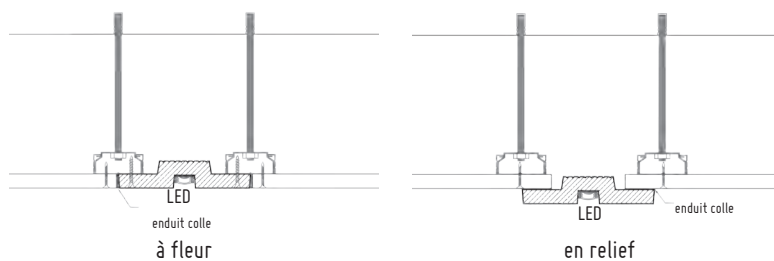
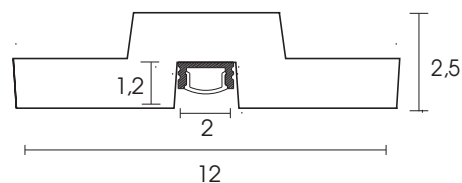

BL122 (en 2 ml)

12 x 2 cm | en 2 ml

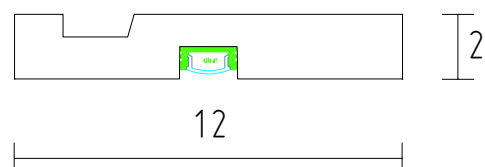

# CORNICHES À ÉCLAIRAGE INDIRECT

BL130 (en 2,6 ml)  
7 x 5 cm

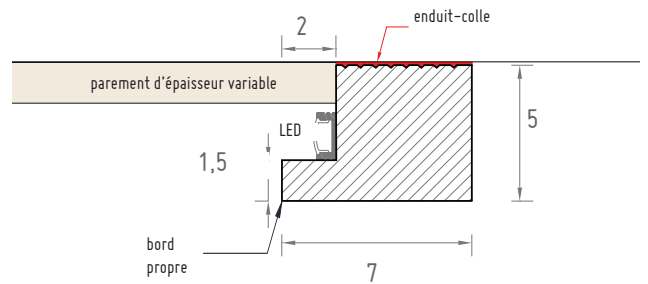

BL131 (en 2,5 ml)  
10 x 7 cm

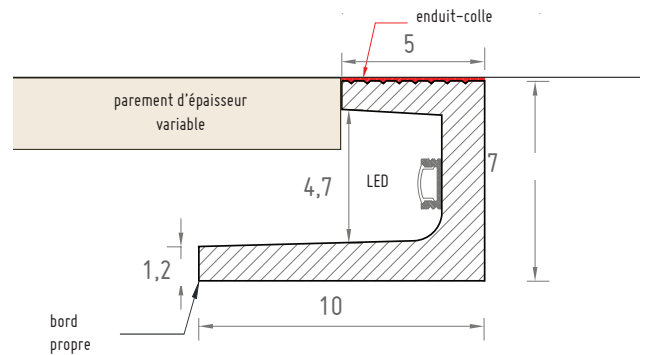
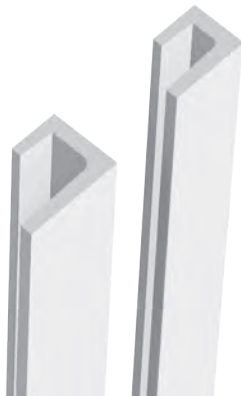

BL132 (en 2,5 ml)  
8 x 5,5 cm

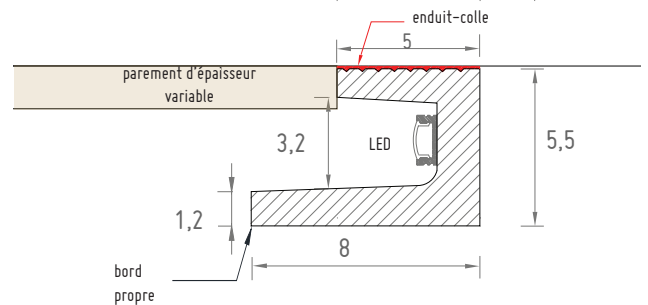
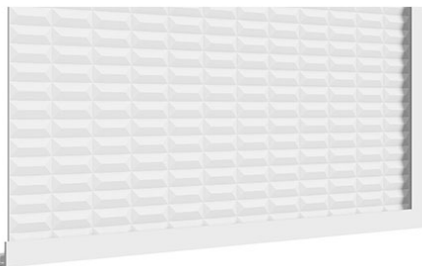

BL160 (en 2 ml)  
19 x 6 cm

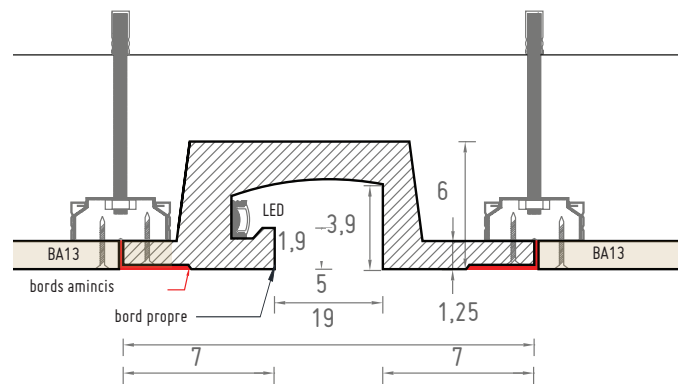

BL180 (en 2ml)  
27,1 x 6,6 cm | en 2 ml

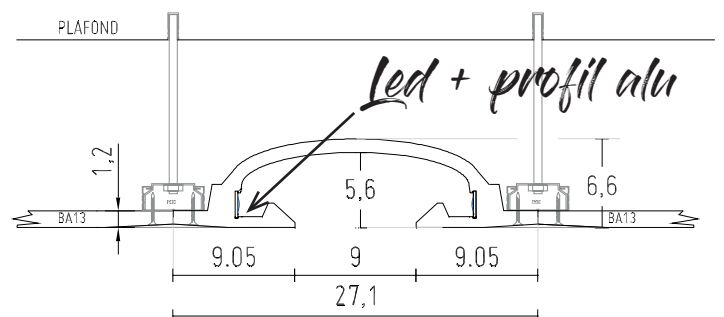
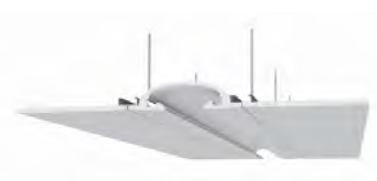

BL170 (en 2 ml)  
19,5 x 4,7 cm

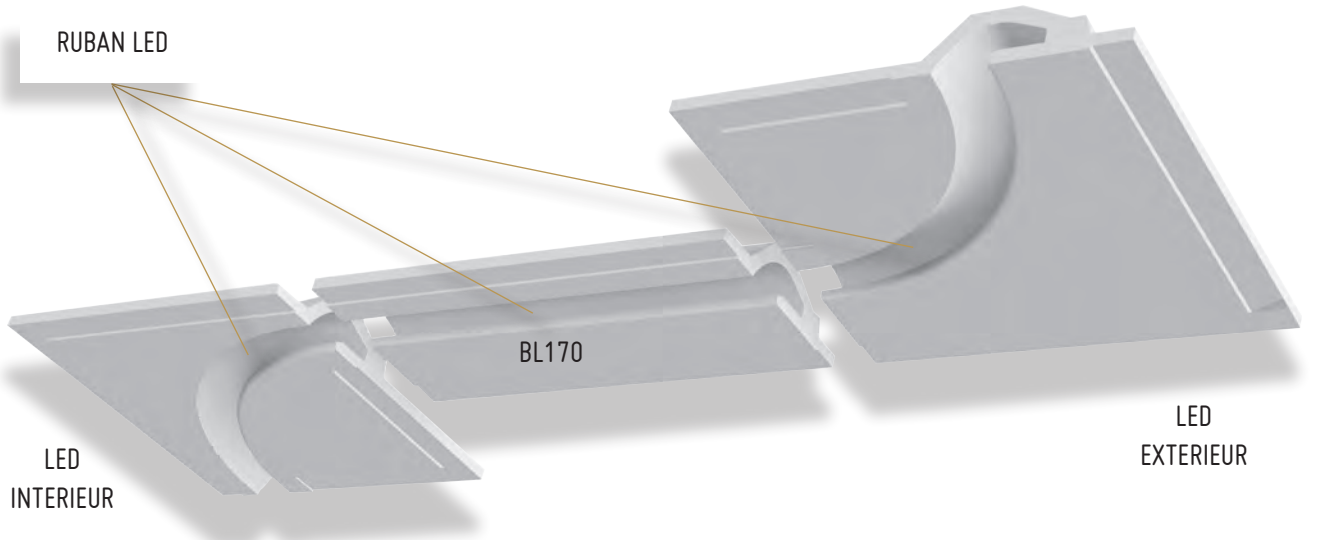
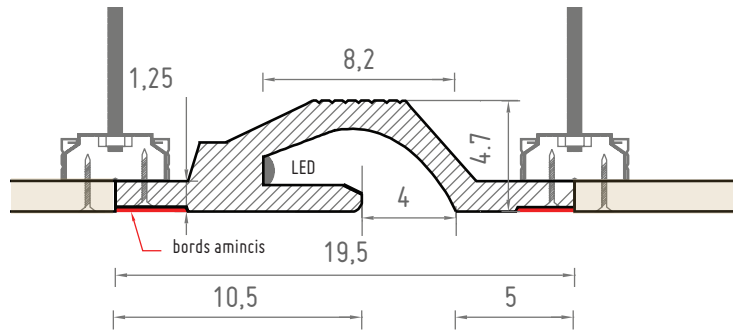

BL170R25I

Gorge lumineuse cintrée de  
25 cm de rayon Led Intérieur  
34 x 34 cm

BL170R25E

Gorge lumineuse cintrée de  
25 cm de rayon Led Extérieur  
35,5 x 35,5 cm

BL170R50I

Gorge lumineuse cintrée de  
50 cm de rayon Led Intérieur  
59 x 59 cm

BL170R50E

Gorge lumineuse cintrée de  
50 cm de rayon Led Extérieur  
60,5 x 60,5 cm

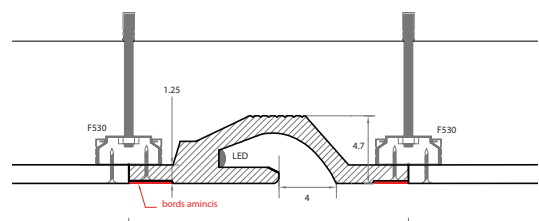

LED INTERIEUR

LED EXTERIEUR

BL170  
en 2 ml



D892 (en 2 ml)

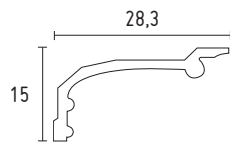

D560 (en 2 ml)

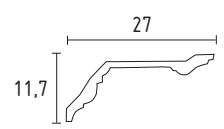

D900 (en 2 ml)

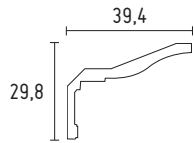

D802 (en 2 ml)

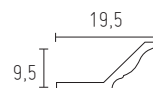

D601 (en 2 ml)

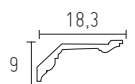

*Le savez-vous ?*

Toutes nos corniches contemporaines, classiques et ornementées peuvent être fabriquées sur-mesure !  
Renseignez-vous auprès de votre agence Staff Décor !



CORNICHE D801  
en 2 ml  
PAGE 33  
© Château Mader

D605 (en 2 ml)

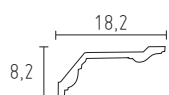

D609 (en 2 ml)

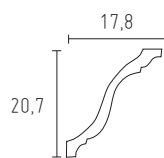

D626 (en 1,75 ml)

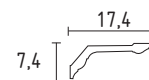

D574 (en 2 ml)

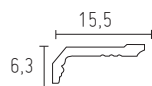

D608 (en 2 ml)

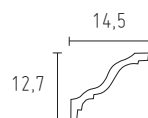

D830 (en 2 ml)

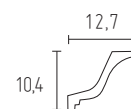

D611 (en 1,75 ml)

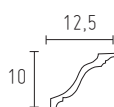

D604 (en 2 ml)

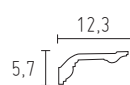

D545 (en 1,75 ml)

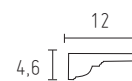

D612 (en 2 ml)



D614 (en 1,75 ml)

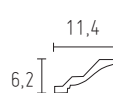

D625 (en 1,75 ml)

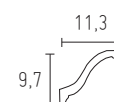

D610 (en 1,75 ml)

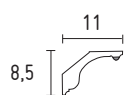

D707 (en 2 ml)

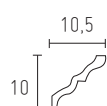

D630 (en 1,75 ml)



D704 (en 2 ml)



D520 (en 1,75 ml)



D703 (en 1,75 ml)



# CORNICHES CLASSIQUES

## ÉCOINÇON DE CORNICHE D880A

Angle : 80 x 80 cm

Hauteur : 18 cm

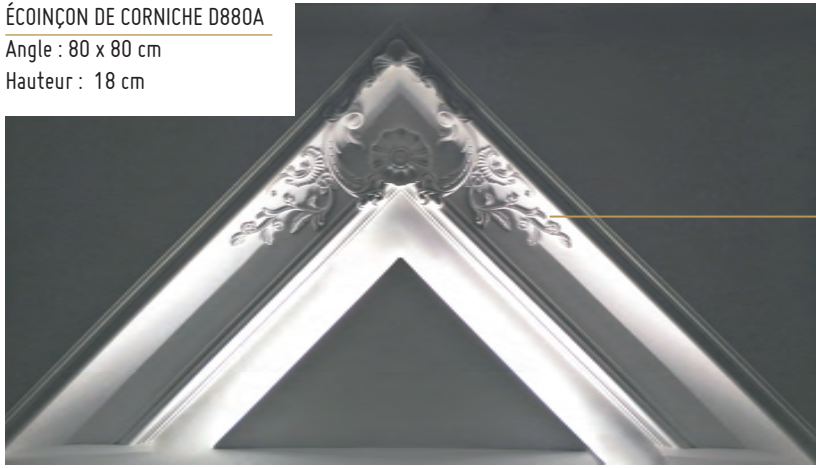

D880 (en 2 ml)

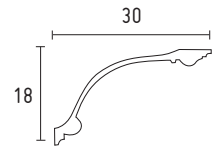

D654 (en 2 ml)

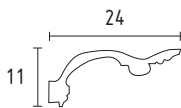

D651 (en 2 ml)

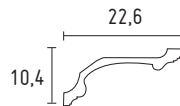

D652 (en 2 ml)

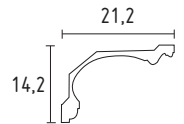

D650 (en 2 ml)

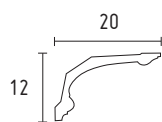

D606 (en 2 ml)

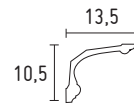

D624 (en 1,75 ml)



D616 (en 1,75 ml)

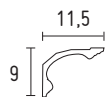

D607 (en 2 ml)

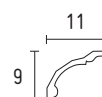

D702 (en 1,75 ml)

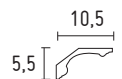

D623 (en 1,75 ml)



D622 (en 1,75 ml)

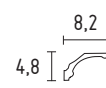

Pour les corniches D601, D606, D611, D616, D702, D707, vous pouvez leur associer un angle rentrant et sortant (par exemple, R601 et S601 pour la corniche D601...).

Angle rentrant  
R702

Angle sortant  
S702



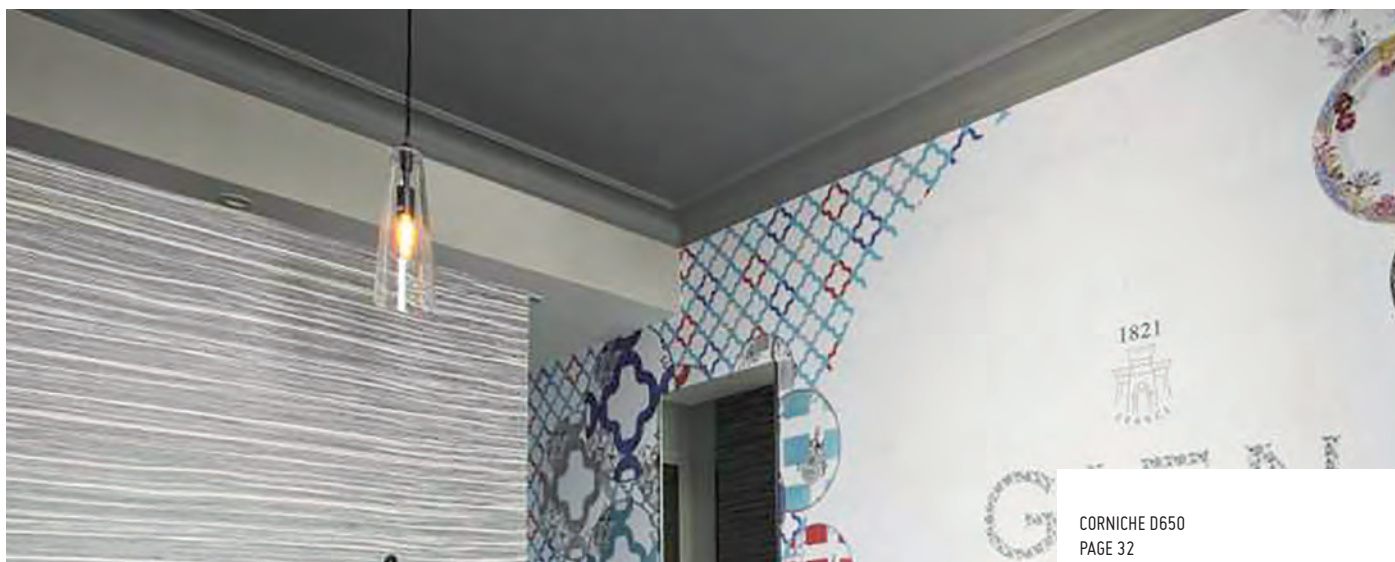

CORNICHE D650  
PAGE 32

D886 (en 2 ml)

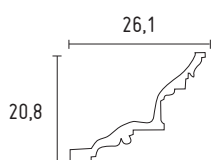

D896 (en 2 ml)

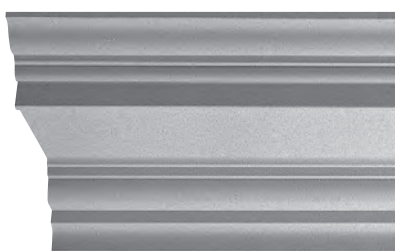
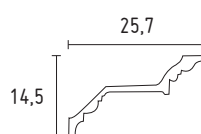

D653 (en 2 ml)

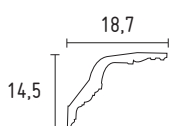

D888 (en 2 ml)

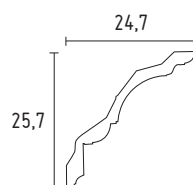

*Corniches pour  
grande  
hauteur  
sous plafond !*

D801 (en 2 ml)

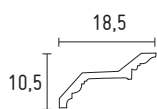

D657 (en 2 ml)



D820 (en 2 ml)

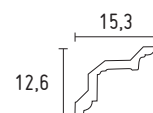

D656 (en 2 ml)



D717 (en 2 ml)

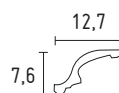

D713 (en 2 ml)

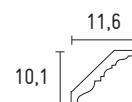

# CORNICHES ORNEMENTÉES

D899 (en 2 ml)

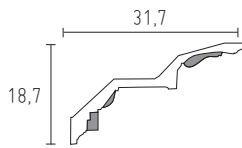

D898 (en 2 ml)

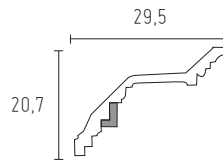

D889 (en 2 ml)

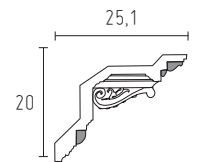

D815 (en 2 ml)

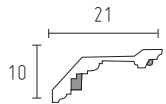

D814 (en 2 ml)

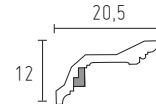

D569 (en 2 ml)

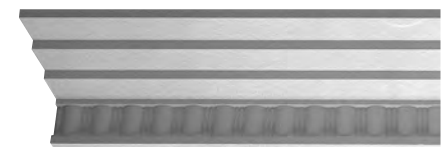
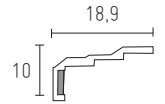

D810  
(en 2 ml)

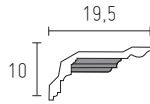

D515 (en 2 ml)

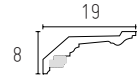

D902 (en 2 ml)

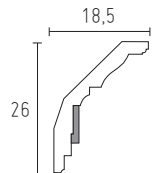

D628 (en 2 ml)

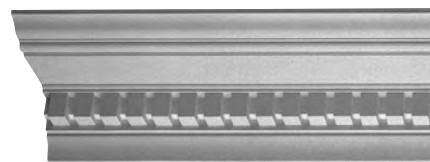
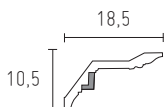

D629 (en 2 ml)

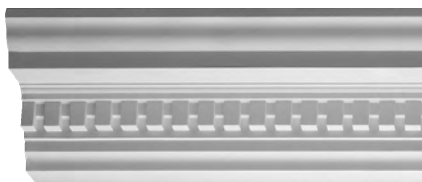

D531 (en 2 ml)

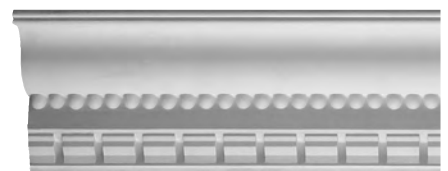
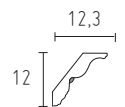

D840 (en 2 ml)

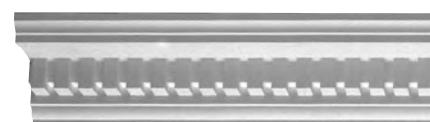
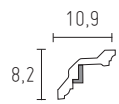

D715 (en 1,75 ml)

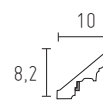

D617 (en 1,75 ml)

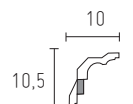

D897 (en 2 ml)

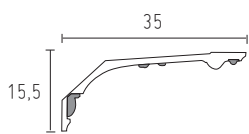

D895  
(en 2 ml)

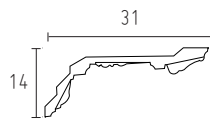

D885 (en 2 ml)

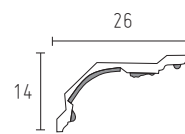

D894 (en 2 ml)

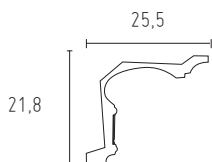

D893  
(en 2 ml)

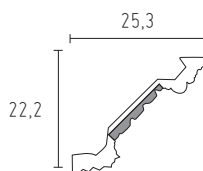

D884  
(en 2 ml)

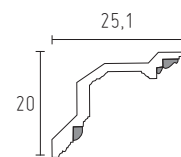

D844 (en 2 ml)

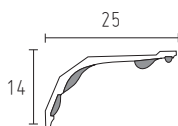

D570 (en 2 ml)

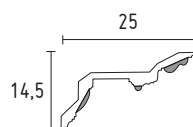

D566 (en 2 ml)

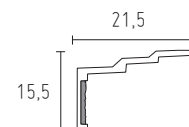

D843 (en 2 ml)

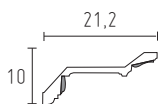

D813 (en 2 ml)

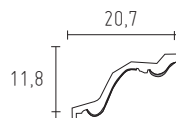

D510 (en 2 ml)

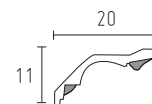

D812 (en 2 ml)

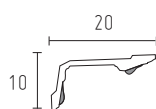

D505 (en 2 ml)

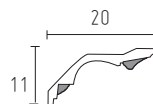

D845 (en 2 ml)

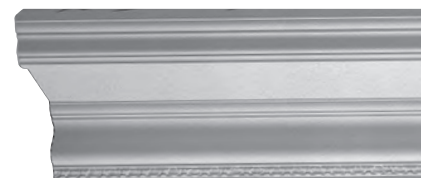
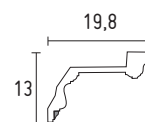

# CORNICHES ORNEMENTÉES

D846 (en 2 ml)

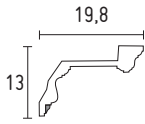

D627 (en 2 ml)

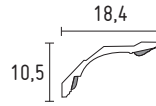

D716 (en 2 ml)

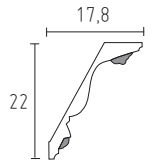

D835 (en 2 ml)

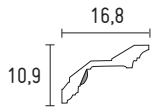

D818 (en 2 ml)

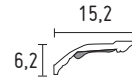

D712 (en 2 ml)

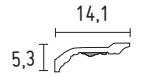

D615 (en 1,75 ml)

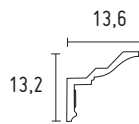

D655 (en 2 ml)

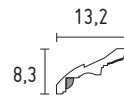

D530 (en 2 ml)

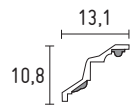

D513 (en 1,75 ml)

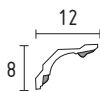

D525 (en 1,75 ml)



D535 (en 1,75 ml)



D711 (en 2 ml)

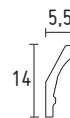

D540 (en 1,75 ml)



D550 (en 1,50 ml)



D890 (en 2 ml)

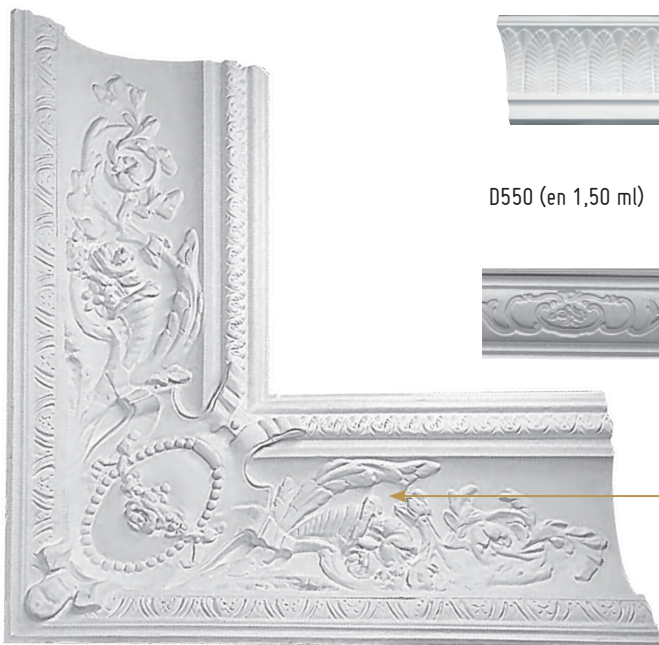
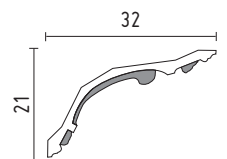

ÉCOINÇON DE CORNICHE D890A

Angle : 80 x 80 cm  
Hauteur : 21cm



### Feuilles d'angle pour corniches

(Pour réf. D505, D510, D601)



R561



S562

## PLAQUES COFFRE

Vendues en longueur de 1,5 m /  
Épaisseur 15 mm

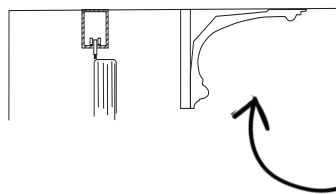

### Les petits + de nos plaques coffre :

- X Pour les finitions impeccables de vos coffres à rideaux associés à une corniche.
- X Pour que vos corniches courent idéalement sur les trémies de vos escaliers.
- X Pour faciliter la pose de vos parements !

- C080  
Plaque coffre haut.80 mm
- C090  
Plaque coffre haut.90 mm
- C0100  
Plaque coffre haut.100 mm
- C0105  
Plaque coffre haut.105 mm
- C0110  
Plaque coffre haut.110 mm
- C0120  
Plaque coffre haut.120 mm



Nos plaques coffre peuvent également être réalisées sur mesure dans nos ateliers (hauteur variable).





MOULURES 1104  
ANGLES DE MOULURES 1104B ET 1104H  
PAGE 42 ET 46

# LES MOULURES

MOULURES 1104  
ANGLES DE MOULURES 1104B ET  
1104H  
PAGE 42 ET 46



# MOULURES LISSES

1365 (en 1,75 ml)



1103 (en 1,50 ml)



1344 (en 1,50 ml)



1364 (en 2,15 ml)



1209 (en 1,75 ml)



1156 (en 1,50 ml)



1367 (en 2,15 ml)



1108 (en 2,15 ml)



1345 (en 2 ml)



1324 (en 2 ml)



1130 (en 2,15 ml)



1125 (en 2,15 ml)



1366 (en 2,15 ml)



1202 (en 1,50 ml)



1155 (en 1,50 ml)



1201 (en 1,50 ml)



1120 (en 2,15 ml)



1343 (en 1,50 ml)



1101 (en 1,50 ml)



1124 (en 2,15 ml)



1107 (en 1,50 ml)



1102 (en 1,50 ml)



1121 (en 2,15 ml)



1207 (en 1,50 ml)



1206 (en 1,50 ml)



1210 (en 1,75 ml)



1220 (en 2,50 ml)



1200 (en 1,50 ml)



1166 (en 1,50 ml)



1221 (en 2,50 ml)



1380 (en 1,50 ml)



 Retrouvez nos moulures de 2,15 ml (couvre-joints) page 106 !



### *Le saviez-vous ?*



Toutes nos moulures contemporaines, classiques et ornementées peuvent être cintrées ! Confiez-nous vos plans et gabarits. Renseignez-vous auprès de votre agence Staff Décor et réalisons vos projets !



# MOULURES ORNEMENTÉES

1208 (en 1,50 ml)



1110 (en 1,25 ml)



1111 (en 1,35 ml)



1112 (en 1,15 ml)



1113 (en 1,65 ml)



1205 (en 1,25 ml)



1104 (en 1,50 ml)



1105 (en 1,50 ml)



1106 (en 1,50 ml)



1109 (en 1,50 ml)



1114D ou 1114G (en 1,50 ml)



1204 (en 1,50 ml)



1157 (en 1,50 ml)



1150 (en 1,55 ml)



1151 (en 1,65 ml)

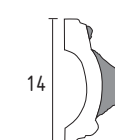

1301 (en 1,50 ml)

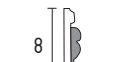
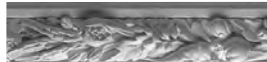

1302 (en 1,50 ml)



1303 (en 1,50 ml)



1304 (en 1,50 ml)

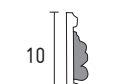

1305 (en 1,50 ml)



1306 (en 1,50 ml)

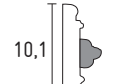

1310 (en 1,50 ml)



1321 (en 1,50 ml)



1322 (en 1,50 ml)



1323 (en 1,50 ml)



1325 (en 1,50 ml)



1326 (en 1,50 ml)

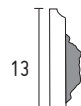

1327 (en 2,00 ml)



1328 (en 1,75 ml)



1329 (en 1,50 ml)



1330 (en 1,50 ml)



1331 (en 1,50 ml)



1332 (en 1,70 ml)

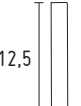

1333 (en 1,50 ml)

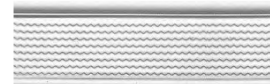

1340 (en 1,80 ml)



1374 (en 1,25 ml)

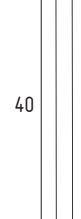

Références 1330, 1331, 1332, 1333 et 1347 : créations Maurice CABROL.

1341 (en 1,50 ml)



1342 (en 1,80 ml)

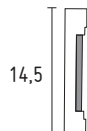

1346 (en 1,50 ml)



1347 (en 1,50 ml)



1348 (en 1,50 ml)



1349 (en 1,50 ml)



1203 (en 2 ml)



1334 (en 2 ml)



1335 (en 2 ml)

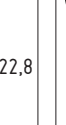

1371 (en 1,80 ml)



1320 (en 1,50 ml)



1373 (en 1,70 ml)



1372 (en 1,70 ml)



MOULURES 1101/1107  
PAGE 40



MOULURE 1101  
ANGLES DE MOULURES 1101H, 1101D ET 1101P  
PAGES 40 ET 47

# ANGLES & DOUCINES DE MOULURES

MOULURE 1151-ANGLE 1151BH  
ÉCOINÇON 1153  
PAGES 42 ET 46

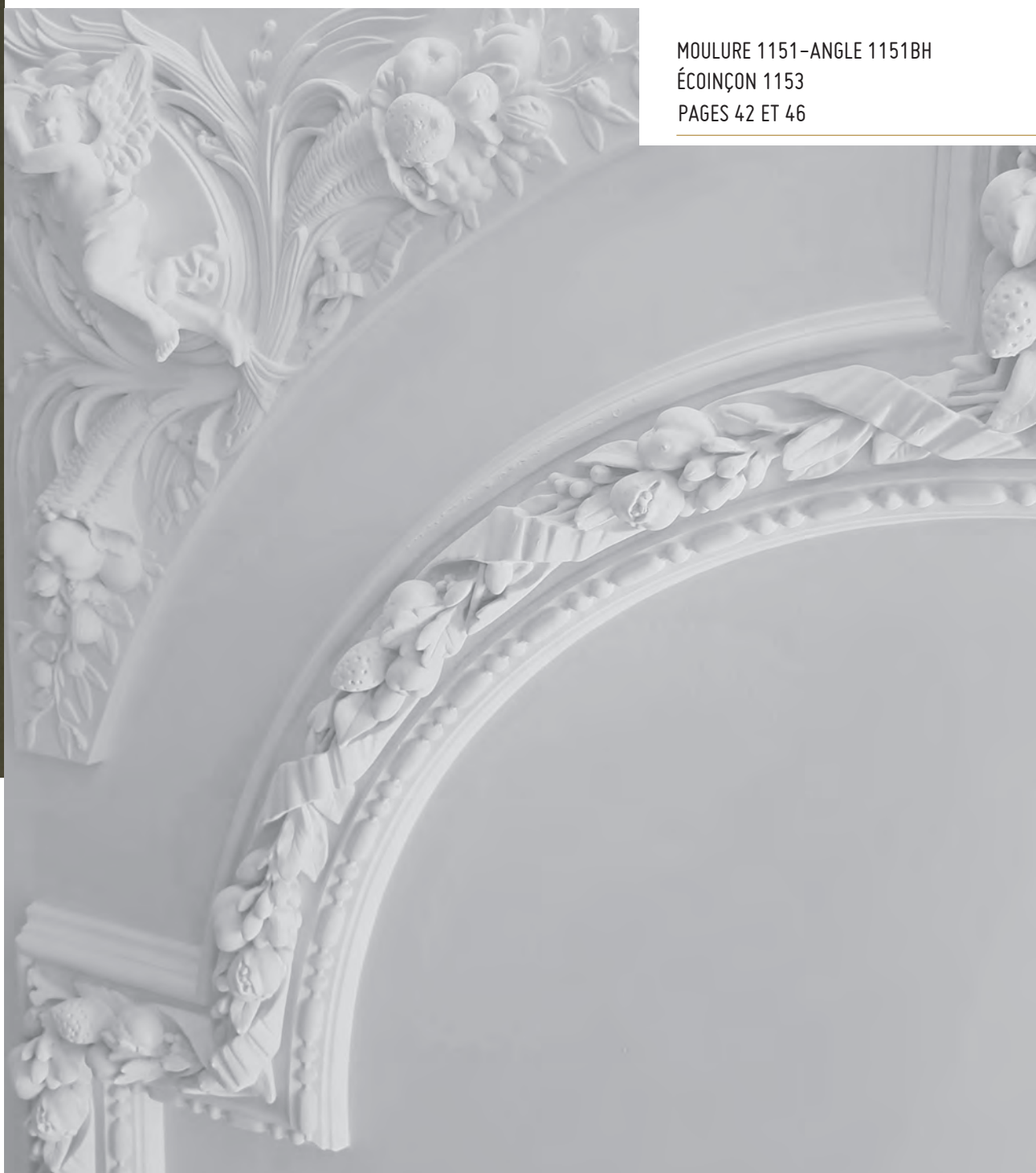



ANGLES & DOUCINES DE MOULURES

1150 (en 1,55 ml)



1104 (en 1,50 ml)

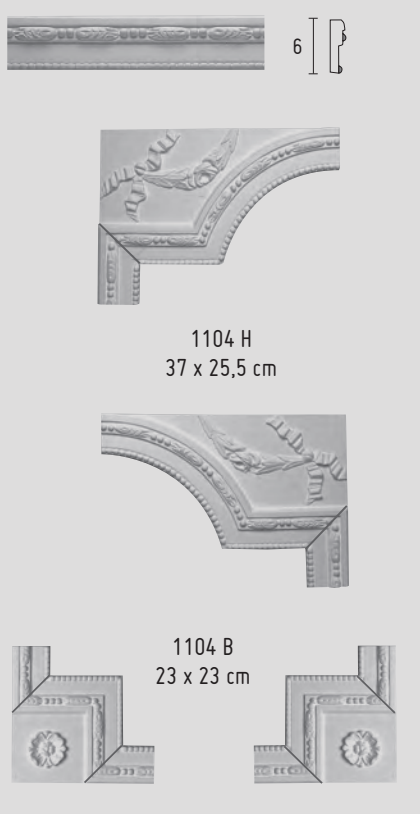

1103 (en 1,50 ml)

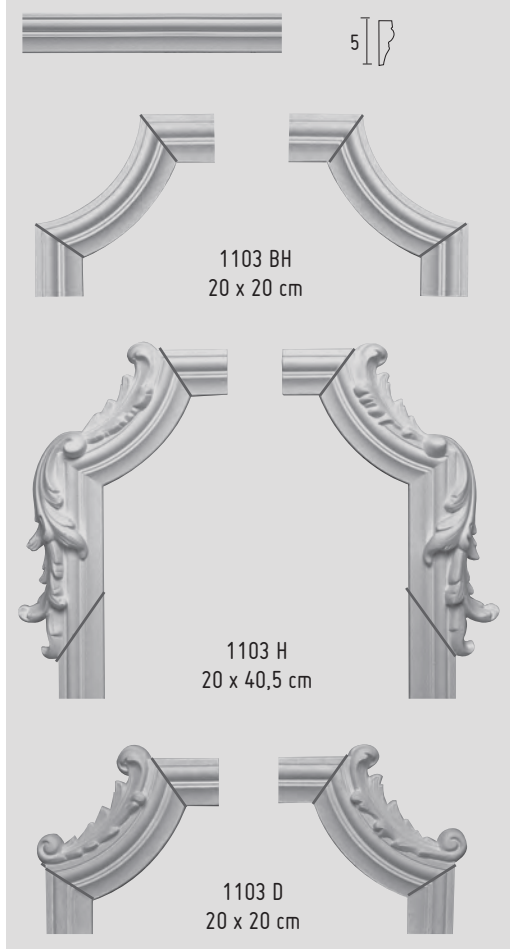

1151 (en 1,65 ml)

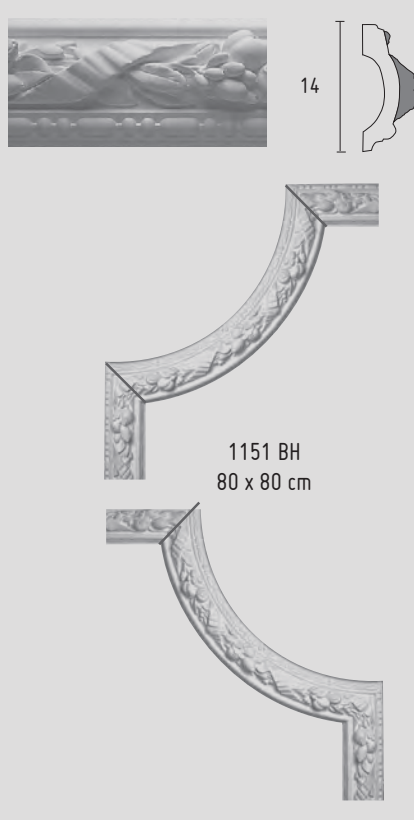

1105 (en 1,50 ml)

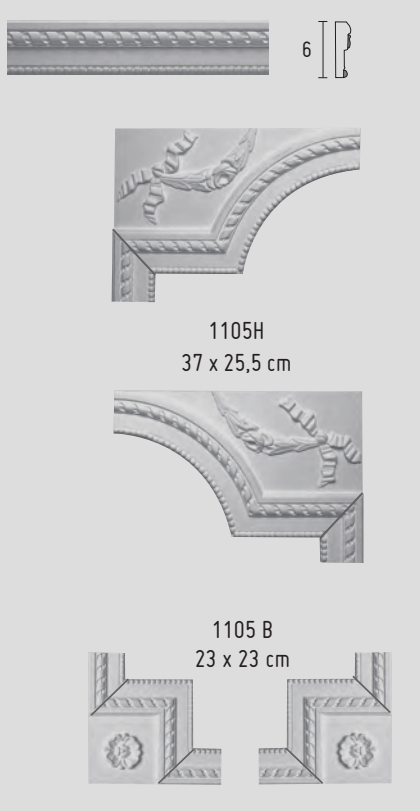

1210 (en 1,75 ml)

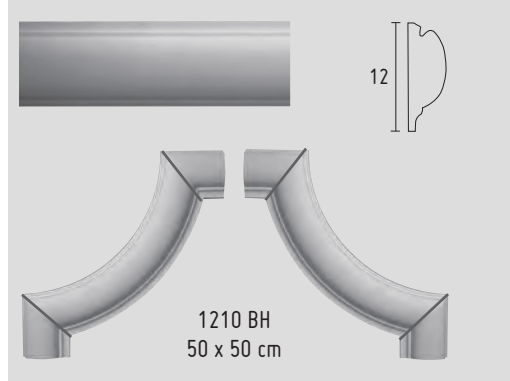

1200 (en 1,50 ml)

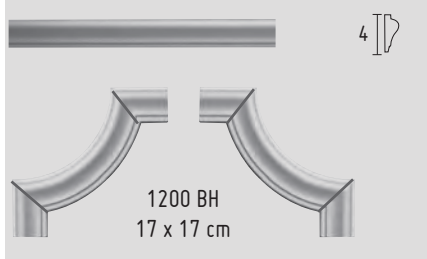

1206 (en 1,50 ml)

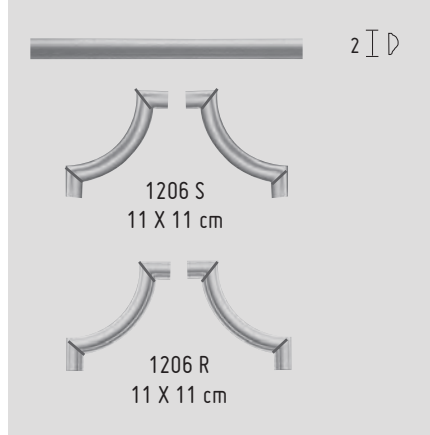

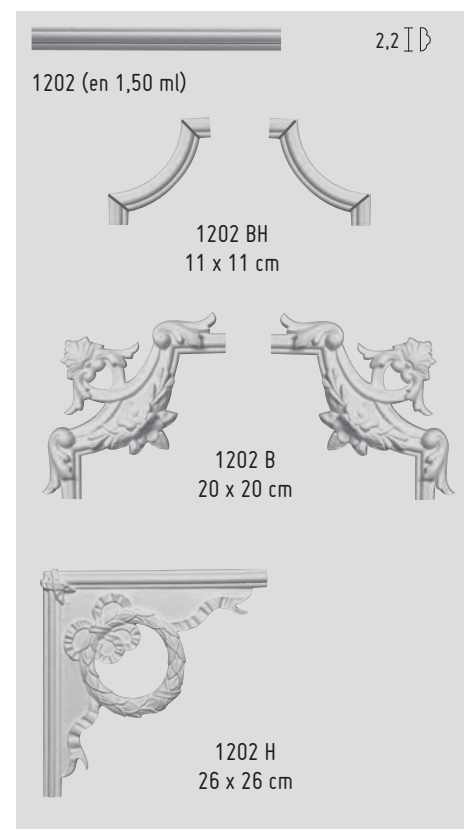
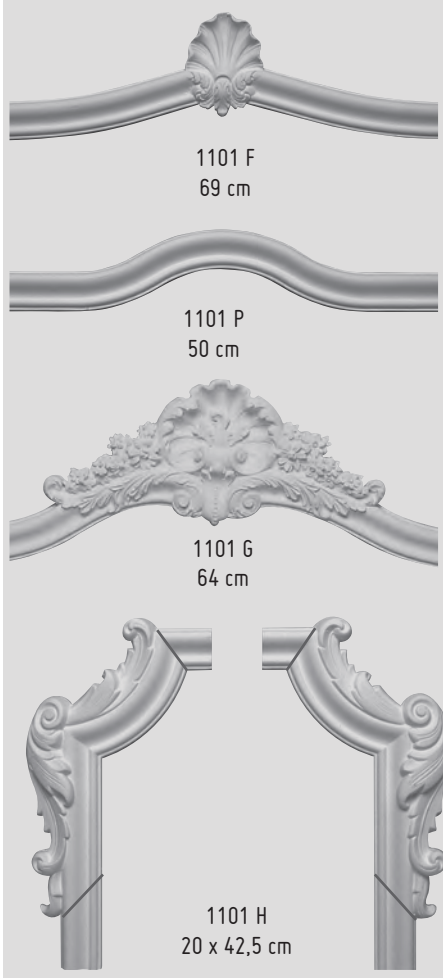
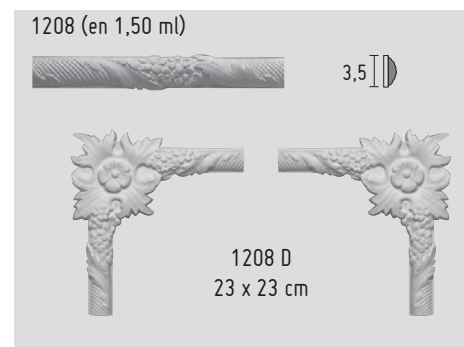
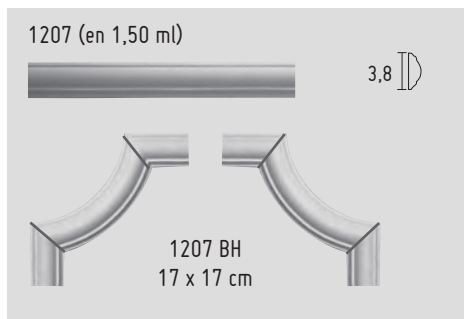
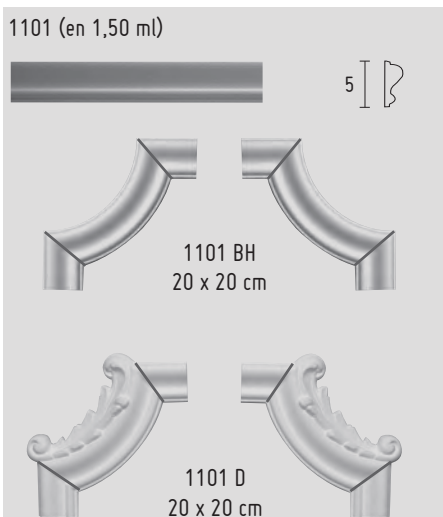
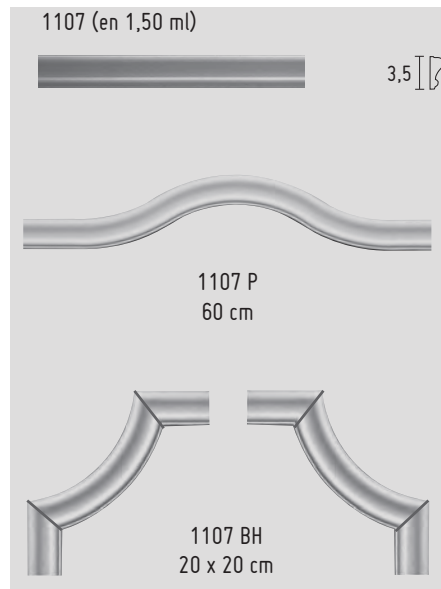
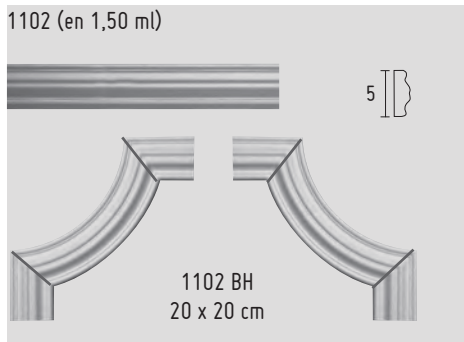
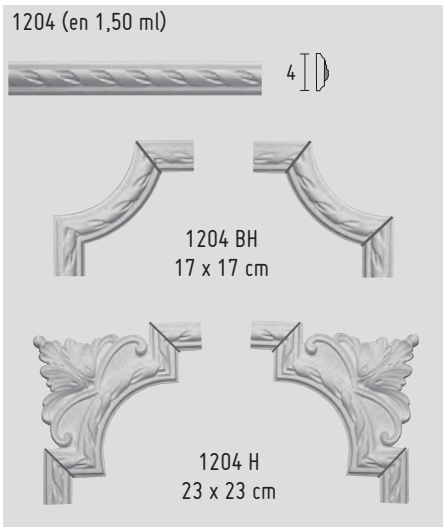

Mise en oeuvre

Pour la pose des angles, coupez les amorces comme indiqué ci-dessus par le trait gris.



ROSACE M250  
PAGE 63

## GUIDE LÉGENDE



Rosace à encastrer ou pouvant être encastrée

# LES ROSACES & LES CAISSONS

ROSACE M405  
PAGE 57



# LES ROSETTES

---



1401 - ø 5,5 cm



1403 - ø 6 cm



1400 - ø 6 cm



M049 - ø 6 cm



1402 - ø 6,5 cm



1415 - ø 7 cm



1416 - ø 8 cm



1413 - 9 x 7 cm



1404 - ø 8,5 cm



1405 - ø 9 cm



M050 - ø 10 cm



1407 - 10,5 x 10,5 cm



1412 - ø 11,5 cm



1406 - ø 12 cm



1408 - ø 14 cm



M038 - ø 16 cm



1414 - ø 19 cm



M043 - ø 29 cm



M047 - ø 32 cm



M041 - ø 32 cm



M058 - ø 32,5 cm



M042 - ø 33 cm



M102 - ø 36 cm



M100 - ø 39 cm



M101 - ø 39 cm



M044 - ø 40 cm



M040 - ø 30 cm



M211 - ø 43,5 cm

ROSACES



M205 - ø 45 cm



M202 - ø 49 cm



M059 - ø 44 cm



M057 - ø 49 cm



M204 - ø 49 cm



M073 - ø 50 cm



M051 - ø 49,5 cm



M072 - ø 51 cm



M061 - ø 52 cm



M056 - ø 51,5 cm



M201 - ø 52 cm



M053 - ø 52 cm



M055 - 65 x 32 cm



M045 - 41 x 30 cm



M213 - ø 46 cm



M206 - ø 57 cm



M046 - 42 x 32 cm



M207 - 53 x 44 cm





M297 - ø 58 cm



M300 - ø 60 cm



M301 - ø 60 cm



M299 - ø 60 cm



M254 - ø 60 cm



M070 - ø 64 cm



M302 - ø 70 cm



M303 - ø 70 cm



M304 - ø 70 cm



M052 - ø 72,5 cm



 M401 - ø 90 cm



 M402 - ø 90 cm



 M403 - ø 87 cm





 M405 - ø 96 cm



ROSACE M405  
© Charles Cameron



ROSACE M400



 M400 - 100 x 70 cm





M209 - 64 x 48 cm



M071 - 88 x 74 cm



M210 - 60 x 41 cm



M068 - 55 x 39 cm



M039 - 59 x 38 cm



M069 - 72 x 42 cm



M203 - ø 50 cm



M048 - 57 x 32 cm



M208 - 51 x 40 cm



 M404 - ø 104 cm



 M067 - 91,5 x 46 cm



 M390 - 105 x 83 cm



 M255 - ø 84 cm



M296 - ø 63 cm



 M407 - 124 x 80 cm



M406 - 84 x 44 cm





M054 - 76 x 61 cm



M306 - ø 80 cm



M298 - 59 x 47 cm



M066 - ø 50 cm



M212 - ø 49 cm



M502 - 88,4 x 95,7 cm  
Livrée avec 3 hexagones en staff, M502H.  
Peut être vendu séparément.





M253 - ø 46 cm



M252 - ø 56 cm



M060 - ø 62 cm



M251 - ø 66 cm



M250 - ø 77 cm



ROSACE M501 - 80 x 80 cm  
© Hôtel Victor Hugo, Pontorson.

CARACTÉRISTIQUES  
TECHNIQUES

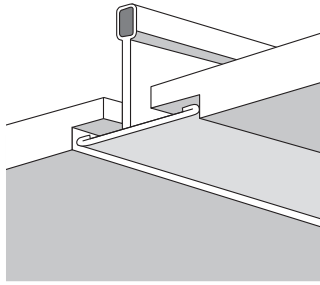

- > Composition : Plâtre armé de fibre de verre.  
Matériau naturel ne contenant aucune substance toxique.
- > Poids : Selon les modèles,  
compris entre 9 et 10 et 22 Kg/m<sup>2</sup>.
- > Réaction au feu : classement M0 et A1  
Non Combustible.
- > Type de montage : Sur ossature semi-cachée  
selon schéma ci-contre ou  
scellement traditionnel.



CAISSON 50.NIAG  
60 x 60 cm  
© The White House, Cannes

50.NIAG  
60 x 60 cm  
Niagara - H 10 cm - 7,7 kg.



50.SIER  
60 x 60 cm  
Sierra - H 9 cm - 7,9 kg.



50.050  
60 x 60 cm  
H 2 cm - 2,7 kg.



50.ATLA  
60 x 60 cm  
Atlas - H 3 cm - 5,4kg.



STAFF DÉCOR peut également réaliser à la demande, tout modèle spécifique de caisson de plafond.



FRONTON B700  
PAGE 69

# COLLECTION ORIENTALE

MOULURE 1250G  
en 2 ml  
PAGE 68

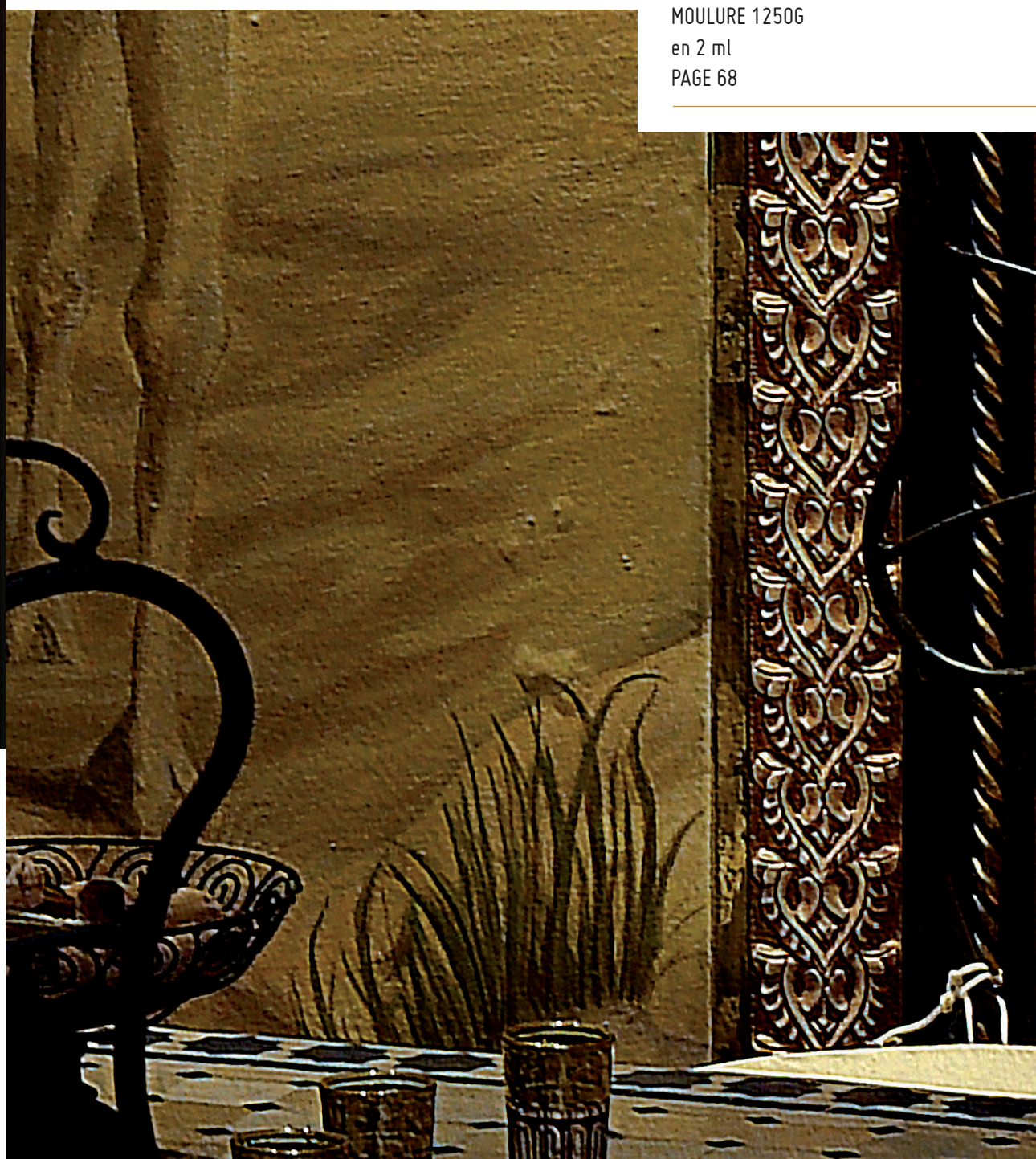

# MOULURES ET FRISES



1250G ou D  
L 200 cm x H 15 cm



1253  
L 210 cm x H 39 cm



1254  
L 215 cm x H 26 cm



1252  
L 187 cm x H 63 cm



1251  
L 209 cm x H 35 cm



1271  
22 x 19 cm

Les écoinçons sont livrés séparément. Ils sont destinés à faciliter les raccords et les arrêts de la frise.

## ABAT-JOUR



1275  
L 150 cm x H 45 cm



Abat-jour 201

# ROSACES



M421  
ø 83 cm



M422  
ø 100 cm



M420  
153 x 81 cm

# FRONTONS & CHAPITEAUX



B700  
Fronton 100 cm x 70 cm  
Flèche : 37 cm - corde : 71 cm



B702  
Fronton 166,5 cm x 68 cm  
Flèche : 52 cm - corde : 167 cm

1/2 chapiteau  
40.61  
22 cm x 11 cm x H 11 cm



B701  
Fronton 125 cm x 83 cm  
Flèche : 57 cm - corde : 95 cm

Demi-fût torsadé  
32.51  
ø 15 cm, H 200 cm



1/2 collerette basse  
45.51C



B703  
79 cm x 20,5 cm



The image shows a corner of a room with dark green walls. The ceiling features a decorative white crown molding with intricate scrollwork. A large, white, ornate mirror frame is mounted on the left wall. To the right, a doorway is framed with a white, arched pediment and a decorative door frame. The lower portion of the walls is covered in white wainscoting with a classic panel design. A small potted plant sits on a white surface in the bottom left corner. Two white text boxes with orange arrows point to specific moldings: one points to the door frame and the other points to the wainscoting.

CÔTÉ DE PASSAGE 2024  
PAGE 140

CIMAISE 1101C  
PAGE 103



FRONTON 3900  
PAGE 106





TÊTE DE PILASTRE 0802  
PAGE 116

PILASTRE 0800  
PAGE 116

PAREMENTS  
PAGE 74

# MURS



	<b>LES PAREMENTS</b>	<b>74</b>
	PIERRES ET BRIQUETTES	76
	COLLECTION BOIS	80
	COLLECTION CONTEMPORAINE	81
	PANNEAUX DE GRANDES DIMENSIONS	92
	<b>L'HABILLAGE MURAL PAR LAMBRISSAGE</b>	<b>96</b>
	PLATE BANDE, ANGLES DE PLATE BANDE & CIMAISES	98
	LAMBRIS DÉCAISSÉS	99
	TÊTES POUR PILASTRES	100
	INTERCALAIRES, STYLOBATES	
	ÉLÉMENTS DE CIMAISES, PLINTHES	101
	AUTRES SOLUTIONS POUR VOS SOUBASSEMENTS	102
	<b>LES HABILLAGES DE PORTE</b>	<b>104</b>
	LE CONTEMPORAIN	104
	LES CLASSIQUES	105
	LES COUVRE-JOINTS	106
	LES TALONS DE PORTE	106
	<b>LES FRONTONS</b>	<b>106</b>
	FRONTONS RECTANGULAIRES	106
	FRONTONS ORNEMENTÉS	107
	<b>LES COLONNES &amp; PILASTRES</b>	<b>108</b>
	LES COLONNES	108
	LES PILASTRES	113
	LES BALUSTRES	117



PAREMENT FACET  
CL31  
PAGE 86

# LES PANNEAUX 3D & PAREMENTS

PAREMENT RR COLLECTION  
7063  
PAGE 91

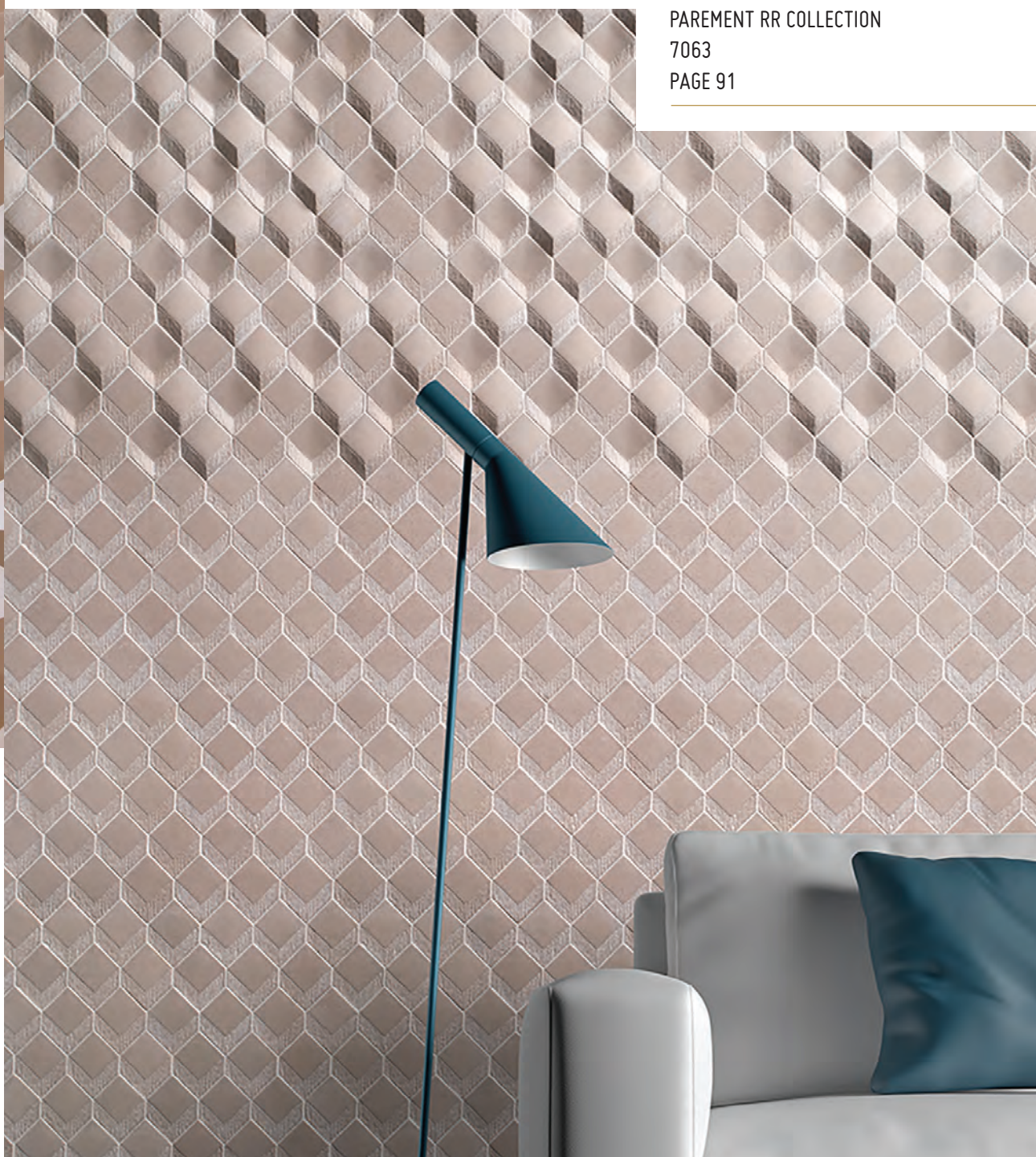

## PIERRES & BRIQUETTES



7060 Bruges  
87 x 60 cm  
Épaisseur : 1,5 cm  
Poids unitaire : 6,5 kg  
Conditionnement à l'unité  
avec briquettes de liaison



7061 New-York  
93 x 54 cm  
Épaisseur : 1,5 cm  
Poids unitaire : 6,5 kg  
Conditionnement à l'unité



SD7054  
Brooklyn  
48,6 x 12,1 x 1,3 cm / unité  
Conditionnement : carton de 20 unités  
Vendu en carton de 0,92 m<sup>2</sup>  
Poids au m<sup>2</sup> : 13 kg



SD7047  
Soho  
9,8 x 50,8 x 1,5 cm / unité  
Conditionnement : carton de 25 unités  
Vendu en carton de 1 m<sup>2</sup>  
Poids au m<sup>2</sup> : 13,5 kg



SD7056  
Queens  
99,5 x 19 x 1,4 cm / unité  
Conditionnement : carton de 5 unités et  
10 briquettes de liaison  
Vendu en carton de 0,94 m<sup>2</sup>  
Poids au m<sup>2</sup> : 13 kg



SD7042  
Harlem  
100x20x1,5cm/unité  
Conditionnement : carton de 5 unités  
Vendu en carton de 1 m<sup>2</sup>  
Poids au m<sup>2</sup> : 13 kg



7038  
Tétris  
100 x 84 cm  
Épaisseur : 2 cm  
Poids unitaire : 10 kg  
Surface : 0,71 m<sup>2</sup>



7040  
Pierre joint sec GM  
100 x 72,5 cm  
Épaisseur : 2 cm  
Poids unitaire : 8,5 kg  
Conditionnement à l'unité  
Surface : 0,56 m<sup>2</sup>



7041  
Pierre joint sec PM  
95 x 72cm  
Poids unitaire : 12,5 kg  
Conditionnement à l'unité  
Surface utile : 0,61 m<sup>2</sup>



7048

Pierre de parement blanche

7049

Pierre de parement teintée

La finition blanche donne l'effet calcaire de la pierre du Gard. La finition teintée dans la masse rappelle la pierre du Tuffeau.

Aucun raccord apparent, les joints sont pré-moulés sur deux côtés du parement (joint vertical et horizontal).

Livrées par carton de 1 m<sup>2</sup> comprenant

- 1 élément 70 x 35 cm / épaisseur : 1,4 cm
- 1 élément 60 x 35 cm / épaisseur : 1,4 cm
- 1 élément 50 x 35 cm / épaisseur : 1,4 cm
- 2 éléments 40 x 35 cm / épaisseur : 1,4 cm
- 3 éléments 12 x 35 cm / épaisseur : 1,4 cm

Poids du carton : 14 kg

Pour les finitions :



7051 (en 1,50 ml) Moulure pierre teintée

7053 (en 1,50 ml) Moulure pierre blanche

Talon TALP  
épaisseur 4 cm

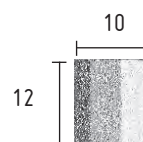

PAREMENTS 7041  
PAGE 76



## COMMENT UTILISER NOS PAREMENTS ?

POUR CLOISONNER OU SÉPARER...



PAREMENT 7073  
PAGE 82

POUR VOS FINITIONS....  
DESSINEZ UN BAR OU UN COMPTOIR...

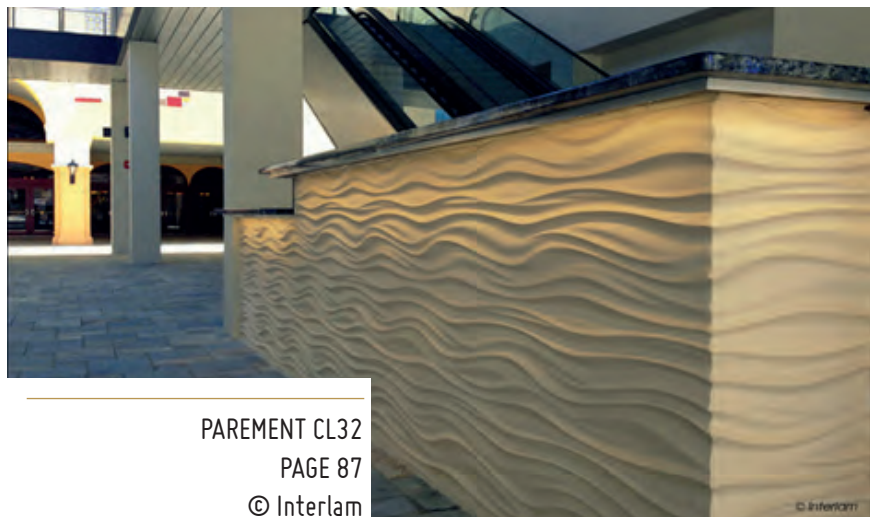

PAREMENT CL32  
PAGE 87  
© Interlam

## POUR UNE TÊTE DE LIT..

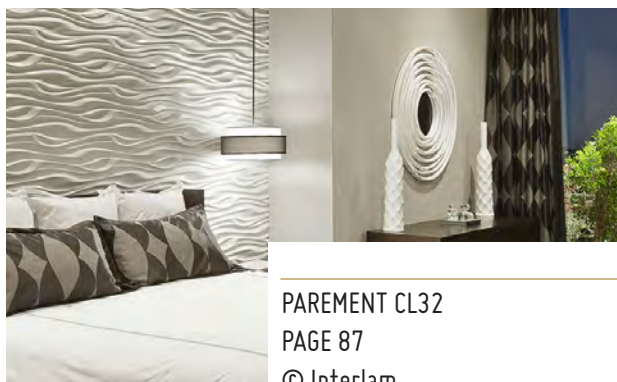

PAREMENT CL32  
PAGE 87  
© Interlam



PAREMENT SD7500  
PAGE 81

## POUR REMPLACER UN TABLEAU...

PAREMENT SD7055  
PAGE 84



### CONSEIL DE POSE :

Pose par collage avec enduit cellulosique de type "Staff Décor"

Les finitions de nos produits sont en plâtre brut et prêts à peindre.

## POUR HABILLER VOS CHEMINÉES...

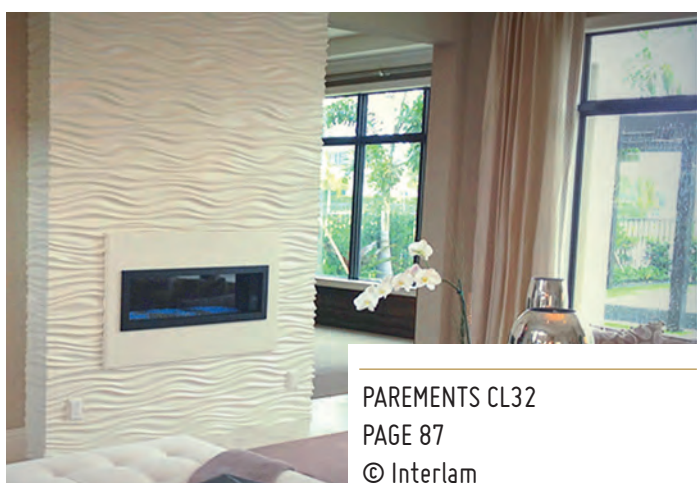

PAREMENTS CL32  
PAGE 87  
© Interlam

DIY ?

Scannez &  
suivez notre tutoriel !



# LES BOIS



PAREMENT SD7043



SD7043  
Forest Hill (Brique)te)  
100 x 20,8 x 1,8 cm / unité  
Conditionnement : carton de 5 unités  
Vendu en carton de 0,94 m<sup>2</sup>  
Poids au m<sup>2</sup> : 15 kg

SD7044  
Forest Hill (Lame)  
100 x 10 x 1,3 cm / unité  
Conditionnement : carton de 10 unités  
Vendu en carton de 1m<sup>2</sup>  
Poids au m<sup>2</sup> : 13,6 kg



SD7052  
Greenwich  
99 x 19,2 x 1,4 cm / unité  
Conditionnement : carton de 5 unités  
et 10 briquettes de liaison  
Vendu en carton de 0,94 m<sup>2</sup>  
Poids au m<sup>2</sup> : 13 kg

SD7057  
120 x 25 x 1,4 cm / unité  
Conditionnement : carton de 2 unités  
Vendu en carton de 0,6 m<sup>2</sup>  
Poids au m<sup>2</sup> : 15 kg

# COLLECTION CONTEMPORAINE



SD7500  
Key West



SD7501  
Daytona



SD7502  
Square Garden

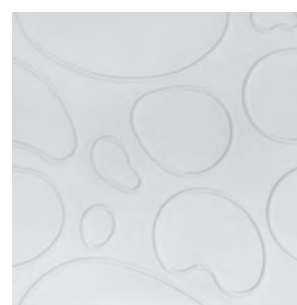

SD7503  
Everglades

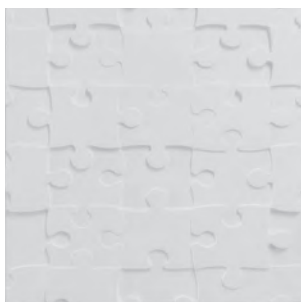

SD7504  
Orlando

## GAMME « JOINTS CREUX »

Caractéristiques techniques communes à l'ensemble de la gamme :

60 x 60 cm / unité

Conditionnement : carton de 2 éléments

Poids du carton : 13 kg sauf SD7500 à 12 kg

Vendu en carton de 0,72 m<sup>2</sup>

Pose par collage avec enduit cellulosique "Staff Décor"

Finition : plâtre brut

Le produit est prêt à peindre.



PAREMENT SD7503

## PAREMENTS

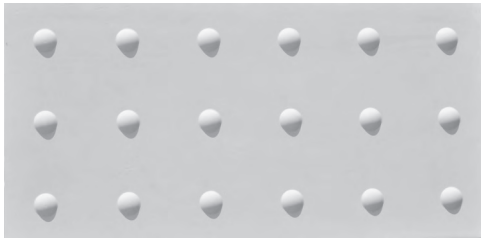

**7070**  
Panneau Bulles  
120 x 60 cm  
Epaisseur : 1,25 cm min / 2,3 cm max  
Poids unitaire : 9,5 kg  
Conditionnement à l'unité  
© Design by Lionel Brehelin



**7071**  
Panneau Golf  
120 x 60 cm  
Epaisseur : 1,25 cm  
Poids unitaire : 9,1 kg  
Conditionnement à l'unité  
© Design by Lionel Brehelin

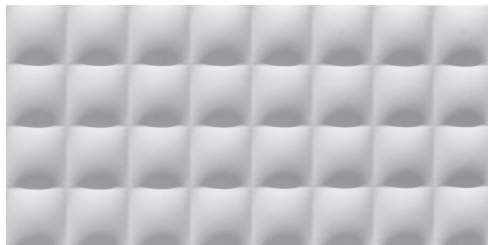

**7072**  
Panneau Capitons  
120 x 60 cm  
Epaisseur : 1,25 cm min / 2,3 cm max  
Poids unitaire : 13,5 kg  
Conditionnement à l'unité  
© Design by Lionel Brehelin



**7073**  
Panneau Macarons  
120 x 60 cm  
Epaisseur : 1,25 cm  
Poids unitaire : 9,2 kg  
Conditionnement à l'unité  
© Design by Lionel Brehelin



**7074**  
Panneau Virgules  
120 x 60 cm  
Epaisseur : 1,25 cm  
Poids unitaire : 9,3 kg  
Conditionnement à l'unité  
© Design by Lionel Brehelin



**7075**  
Panneau Caro  
120 x 60 cm  
Epaisseur : 1,25 cm  
Poids unitaire : 9,2 kg  
Conditionnement à l'unité  
© Design by Lionel Brehelin



PAREMENT 7072

PAGE 82

© Design by Lionel Brehelin



*Besoin de conseils pour le choix de vos parements ? Découvrez notre article et inspirez-vous !*



**50.LET1**  
Dalle palmier droite  
40 x 40 cm  
Epaisseur : 1,5 cm  
Conditionnement à l'unité  
Poids unitaire : 3kg  
© Design by Patrick le Tuault



**50.LET2**  
Dalle palmier gauche  
40 x 40 cm  
Epaisseur : 1,5 cm  
Conditionnement à l'unité  
Poids unitaire : 3kg  
© Design by Patrick le Tuault



**50.LET3**  
Dalle palmier  
40 x 40 cm  
Epaisseur : 1,5 cm  
Conditionnement à l'unité  
Poids unitaire : 3kg  
© Design by Patrick le Tuault



**SD7045**  
Luna Park (Lame)  
100 x 20 x 1,3 cm / unité  
Conditionnement : carton de 5 unités  
Vendu en carton de 1 m<sup>2</sup>  
Poids au m<sup>2</sup> : 13 kg



**SD7055**  
Broadway  
40 x 40 x 2 cm / unité  
Conditionnement : carton de 6 unités  
Vendu en carton de 0,96 m<sup>2</sup>  
Poids au m<sup>2</sup> : 12 kg

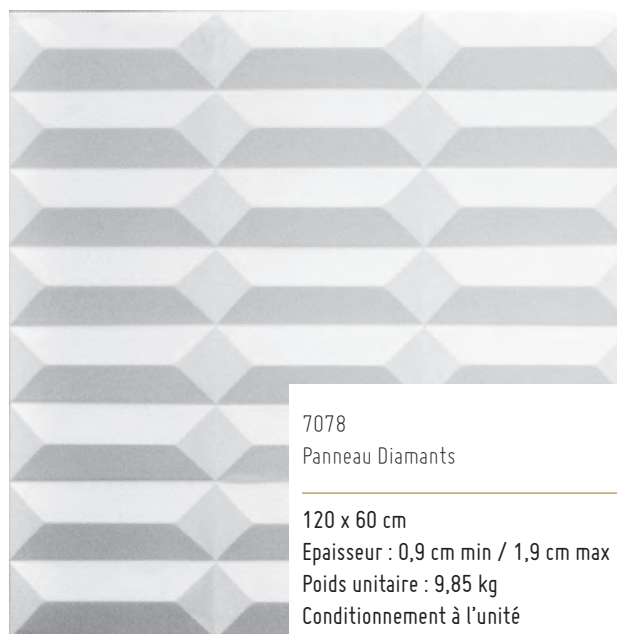

**7078**  
Panneau Diamants  

---

120 x 60 cm  
Epaisseur : 0,9 cm min / 1,9 cm max  
Poids unitaire : 9,85 kg  
Conditionnement à l'unité



SD7046  
 V<sup>è</sup>me avenue  
 40 x 40 x 1,5 cm / unité  
 Conditionnement : carton de 6 unités  
 Vendu en carton de 0,96 m<sup>2</sup>  
 Poids au m<sup>2</sup> : 13 kg

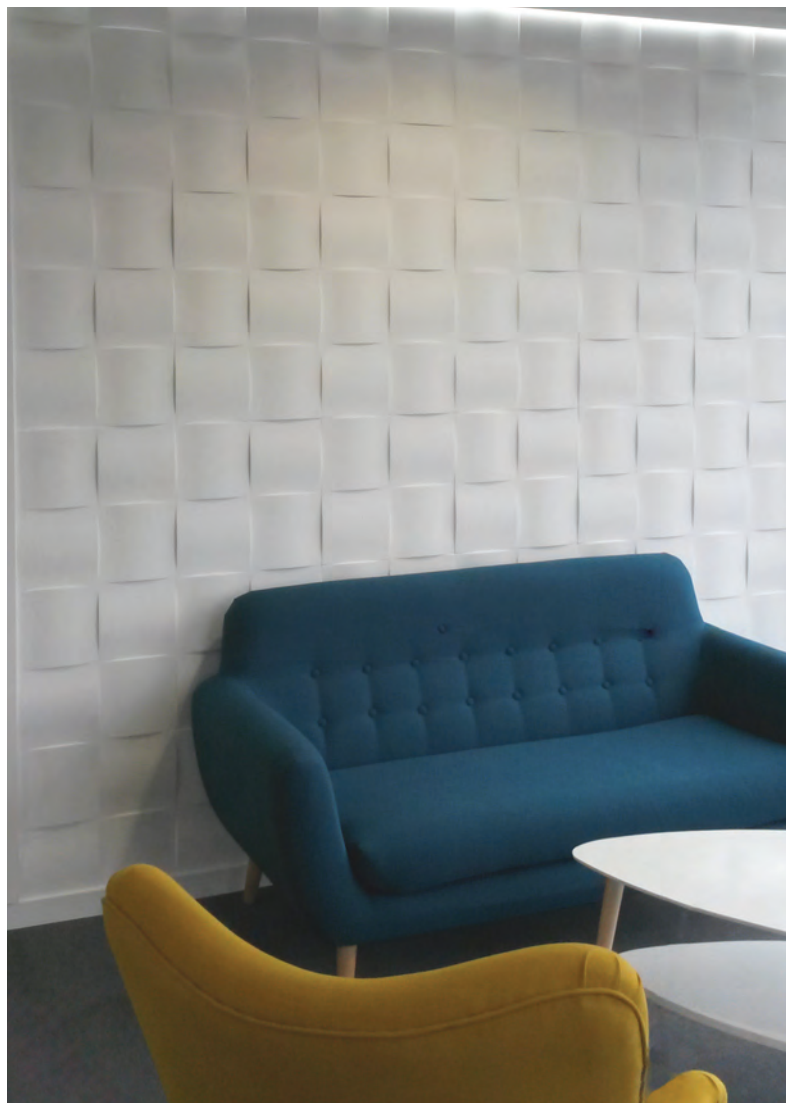

7080  
 Squadra  
 40 x 40 x 1,5 cm / unité  
 Conditionnement : carton de 6 unités  
 Vendu en carton de 0,96 m<sup>2</sup>  
 Poids au m<sup>2</sup> : 13 kg

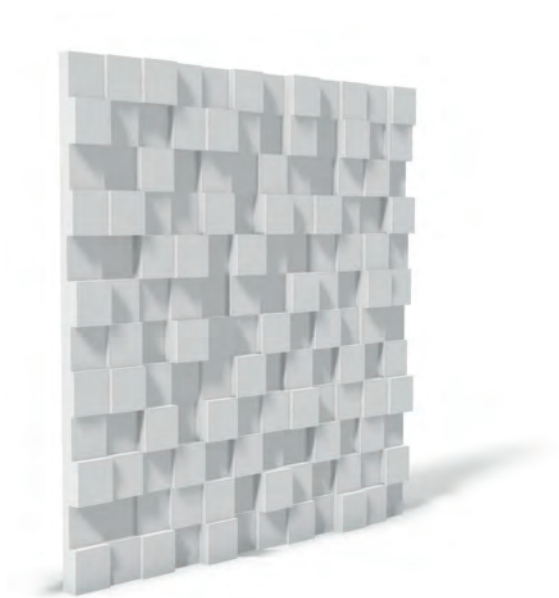

PAREMENTS 7080  
 Squadra



# Nos best-off

Peut être  
raccordé.



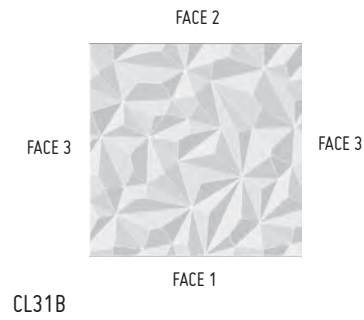
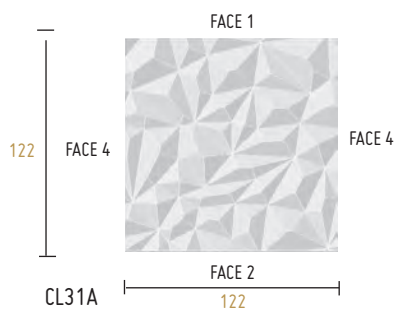

CL31A et B  
Facet  
122 x 122 cm  
Conditionnement à l'unité  
Epaisseur : 2 cm  
Surface : 1,49 m<sup>2</sup> / plaque  
Poids unitaire : 23 kg  
© Design by Interlam



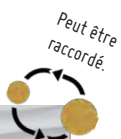

PAREMENT CL32  
© Interlam



Peut être  
raccordé.



CL32  
Vague relief  
122 x 122 cm  
Conditionnement à l'unité  
Epaisseur : 1,6 à 3,5 cm  
Surface : 1,49 m<sup>2</sup> / plaque  
Poids unitaire : 16 kg  
© Design by Interlam

CL33  
Cloud  
122 x 122 cm  
Conditionnement à l'unité  
Epaisseur : 1,2 à 3 cm  
Surface : 1,49 m<sup>2</sup> / plaque  
Poids unitaire : 16 kg  
© Design by Interlam

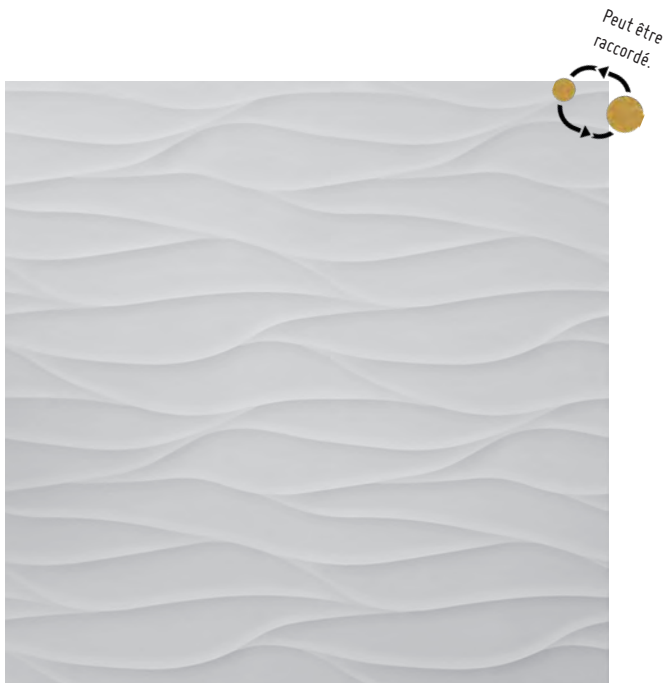

CL34  
Bio  
122 x 122 cm  
Conditionnement à l'unité  
Épaisseur : 3 à 3,7 cm  
Surface : 1,49 m<sup>2</sup> / plaque  
Poids unitaire : 18 kg  
© Design by Interlam



CL35  
Crystal  
122 x 122 cm  
Conditionnement à l'unité  
Épaisseur : 3 à 3,7 cm  
Surface : 1,49 m<sup>2</sup> / plaque  
Poids unitaire : 18 kg  
© Design by Interlam



CL36  
Prisme  
122 x 122 cm  
Conditionnement à l'unité  
Épaisseur : 3,2 cm  
Surface : 1,49 m<sup>2</sup> / plaque  
Poids unitaire : 18 kg



PAREMENTS 7035

Labrys

Plaque de 30,4 x 48,15 cm  
Conditionnement à l'unité  
Épaisseur : 3,6 cm  
Surface : 0,09 m<sup>2</sup>  
Poid unitaire : 3,2 kg/plaque  
© Design by Interlam

# SOLUTION D'HABILLAGES CLÉ EN MAIN

*Une plaque  
de parement*



7036  
Multiface  
Plaque de 8 carreaux de 106,6 x 47,9 cm  
Conditionnement à l'unité  
Épaisseur : 3,7 cm  
Surface : 0,4 m<sup>2</sup>  
Poids unitaire : 9,6 kg  
© Design by Interlam

*des pièces  
individuelles*

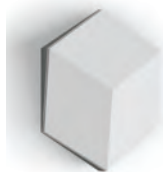

7036U  
1 carreau de 23,6 x 27,4 cm  
Conditionnement à l'unité  
Épaisseur : 3,7 cm  
Surface : 0,05 m<sup>2</sup>  
Poids unitaire : 1,2 kg  
© Design by Interlam

*Une plinthe  
mise en forme*



7036PLIN  
Plinthe de 1,42 ml  
Conditionnement à l'unité  
Hauteur : 16,9 cm  
Épaisseur : 2,2 cm  
Surface : 0,19 m<sup>2</sup>  
Poids unitaire : 2,8 kg  
© Design by Interlam

PAREMENT 7036  
Multiface  
© Interlam



## LES PAREMENTS SIGNÉS GIOVANNI BARBIERI



7039A

44 x 44 cm - épaisseur : 3,5 cm environ

Conditionnement à l'unité

Surface : 0,12 m<sup>2</sup>

Poids unitaire : 2,7 kg soit 22,5 kg/m<sup>2</sup> environ

© Barbieri

7039B

44 x 44 cm - épaisseur : 3,5 cm environ

Conditionnement à l'unité

Surface : 0,12 m<sup>2</sup>

Poids unitaire : 2,7 kg soit 22,5 kg/m<sup>2</sup> environ

© Barbieri

*Composez en fonction de vos envies !*

PAREMENTS 7039A & 7039B  
FLOWER

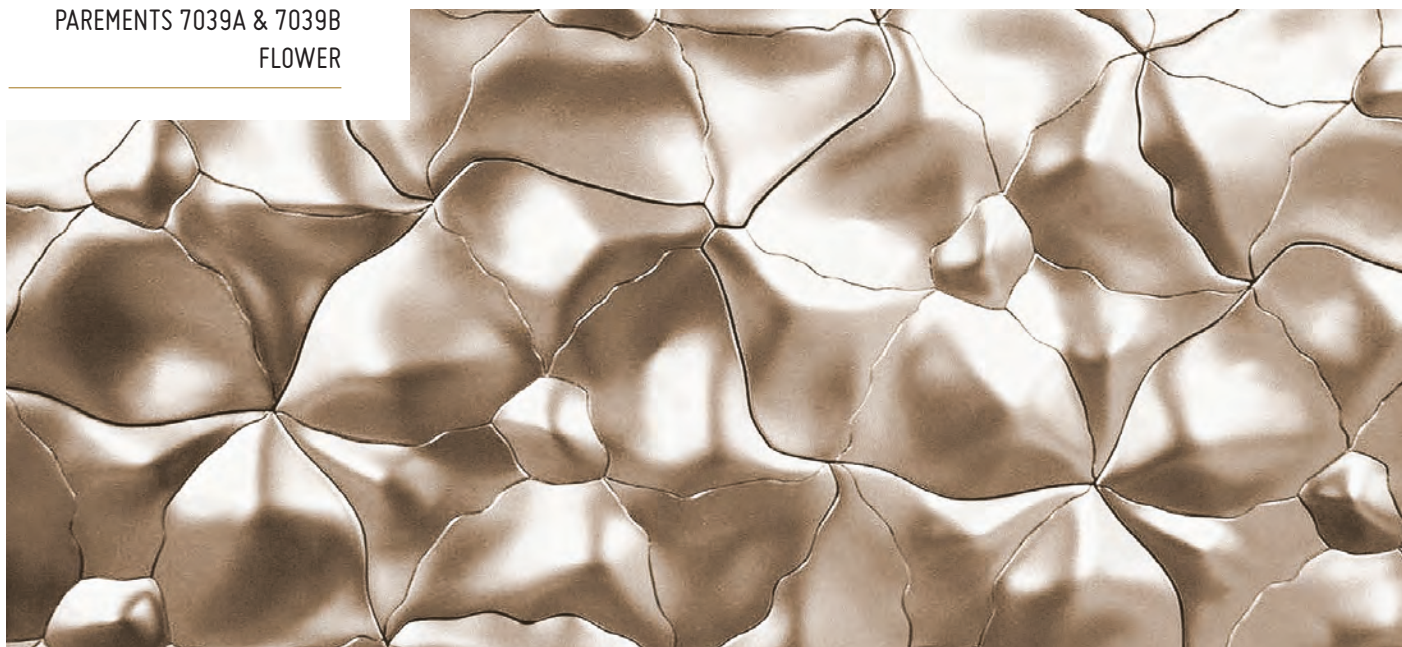

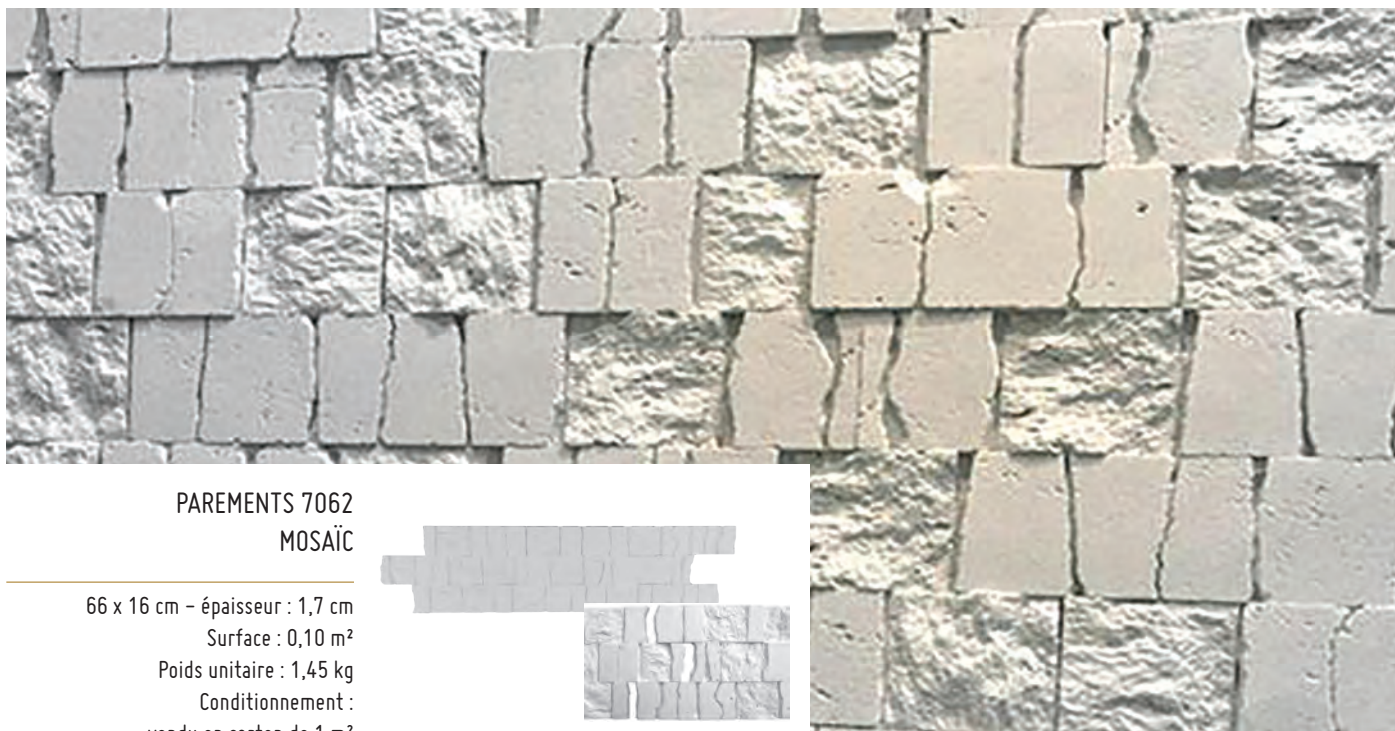

### PAREMENTS 7062 MOSAÏC

66 x 16 cm – épaisseur : 1,7 cm  
 Surface : 0,10 m<sup>2</sup>  
 Poids unitaire : 1,45 kg  
 Conditionnement :  
 vendu en carton de 1 m<sup>2</sup>  
 © Barbieri



Détail du raccord

*Scannez pour découvrir nos  
solutions de calepinage !*



À partir de 4 matrices différentes, composez vous-même un  
habillage mural à votre image !

### PAREMENTS 7063 RR COLLECTION

40,5 x 29,4 cm  
 Epaisseur variable en fonction du motif. Entre 1,3 cm et 2,5 cm.  
 Poids unitaire : 1,45 kg  
 7063-1 : Motifs plats  
 7063-2 : Motifs plats et incurvés  
 7063-3 : Motifs incurvés et bombés  
 7063-4 : Motifs bombés  
 Conditionnement :  
 Les éléments peuvent être vendus à l'unité.

© Barbieri



## LES PANNEAUX GRANDES DIMENSIONS

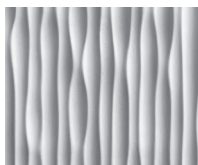
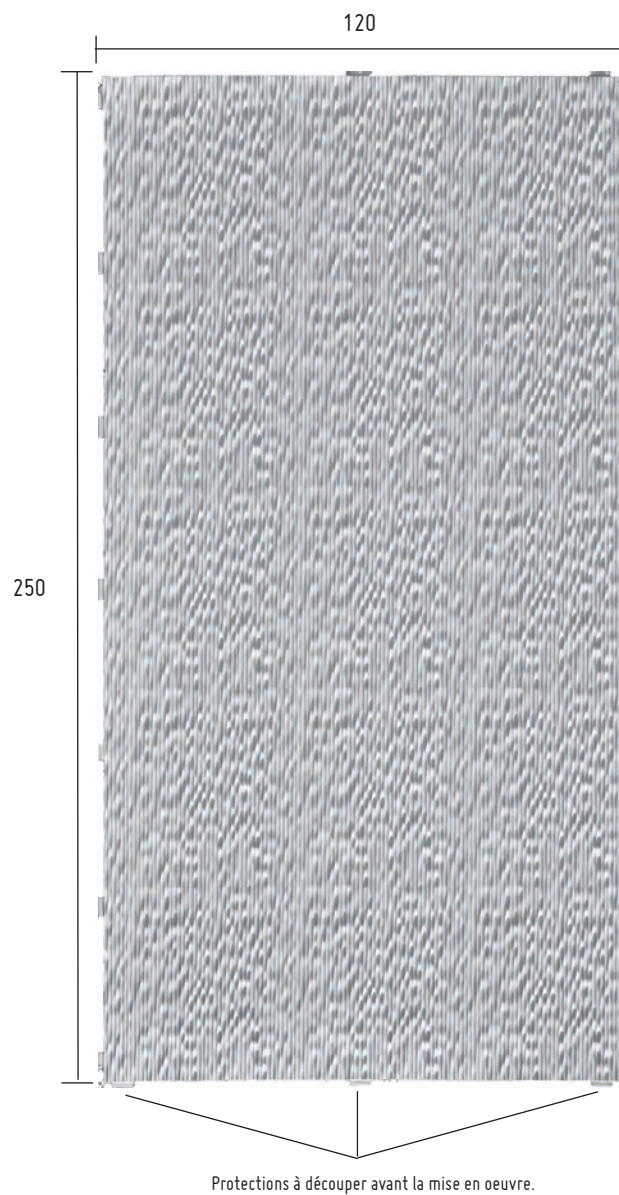

**CL10**  
Motif vertical  
Dimensions : 120 x 250 cm  
Conditionnement à l'unité  
Surface : 3 m<sup>2</sup>  
Poids unitaire : 18 kg.

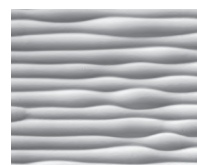

**CL11**  
Motif horizontal  
Dimensions : 120 x 250 cm  
Conditionnement à l'unité  
Surface : 3 m<sup>2</sup>  
Poids unitaire : 18 kg.



### Mise en oeuvre :

Collage des panneaux à l'enduit STAFF DECOR (seau de 10 kg, référence 0010) sur les supports courants (plâtre, béton, plaque de plâtre ...).

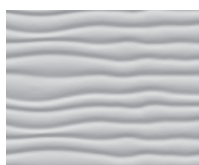
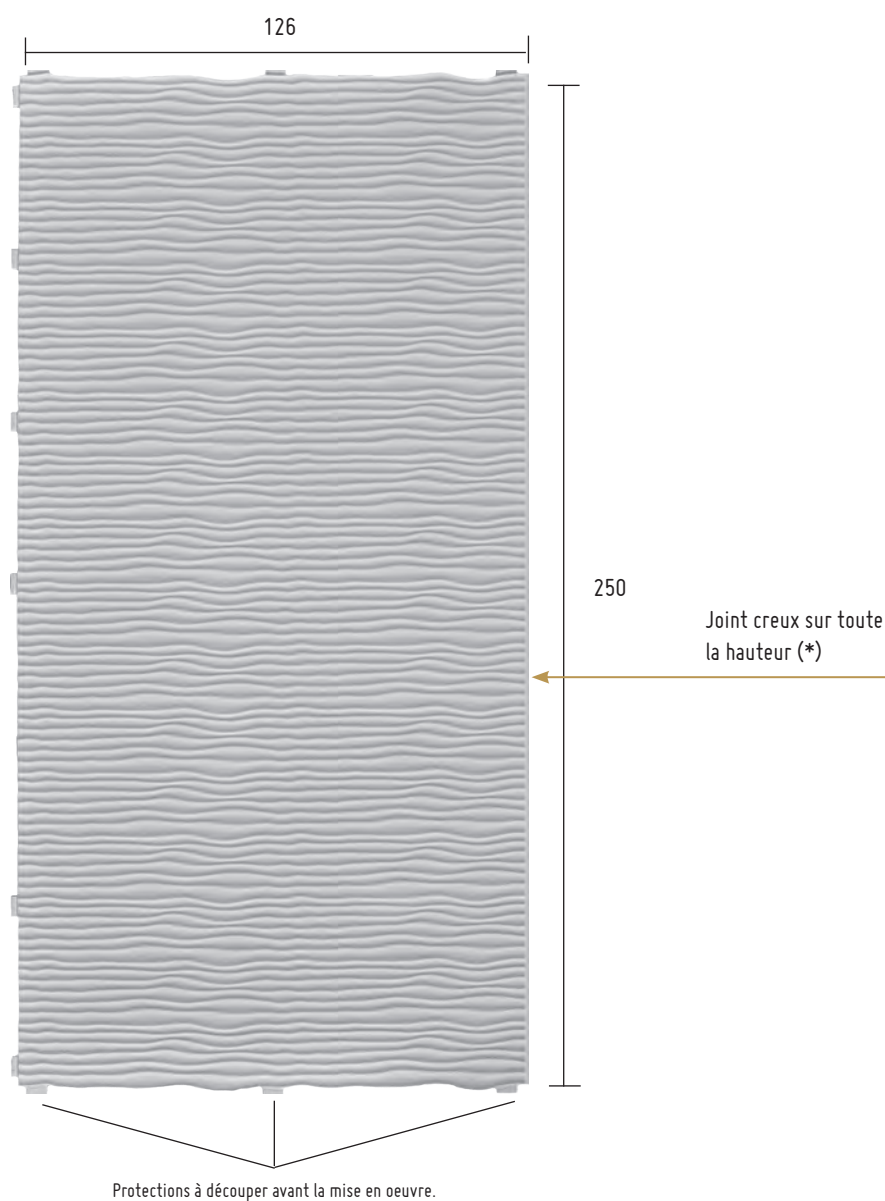

CL1374

Dimensions :

126 x 250 cm

Conditionnement à l'unité

Surface : 3,15 m<sup>2</sup>

Poids unitaire : 18 kg.



Zoom

sur le joint creux.

\*Le panneau référence CL1374 présente un joint creux d'une largeur de 1 cm sur un côté. Pour un résultat sans raccord apparent (bord à bord), ce joint doit être découpé.

Pensez à composer :

Découvrez la moulure **1374** afin d'accompagner votre parement!

(page 42 de notre catalogue)





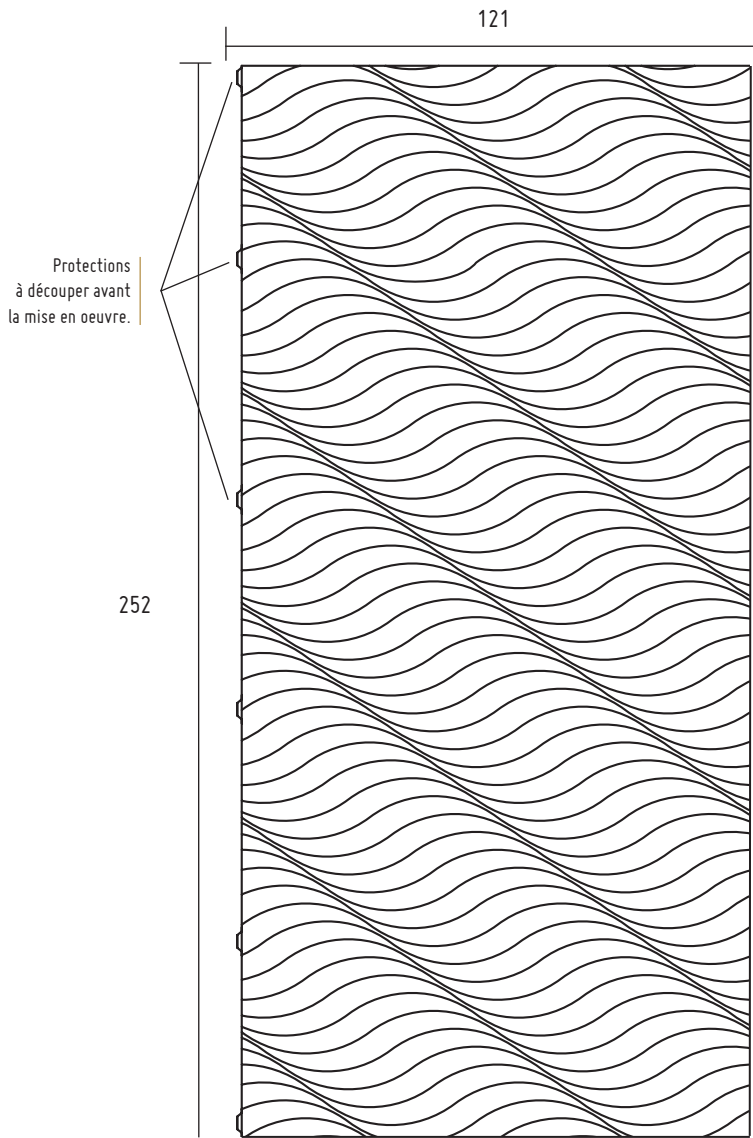

CL12 Ondes  
 Dimensions : 121 x 252 cm  
 Conditionnement à l'unité  
 Surface : 3,05 m<sup>2</sup>  
 Poids unitaire : 18 kg.

Joint creux sur toute la hauteur (\*)

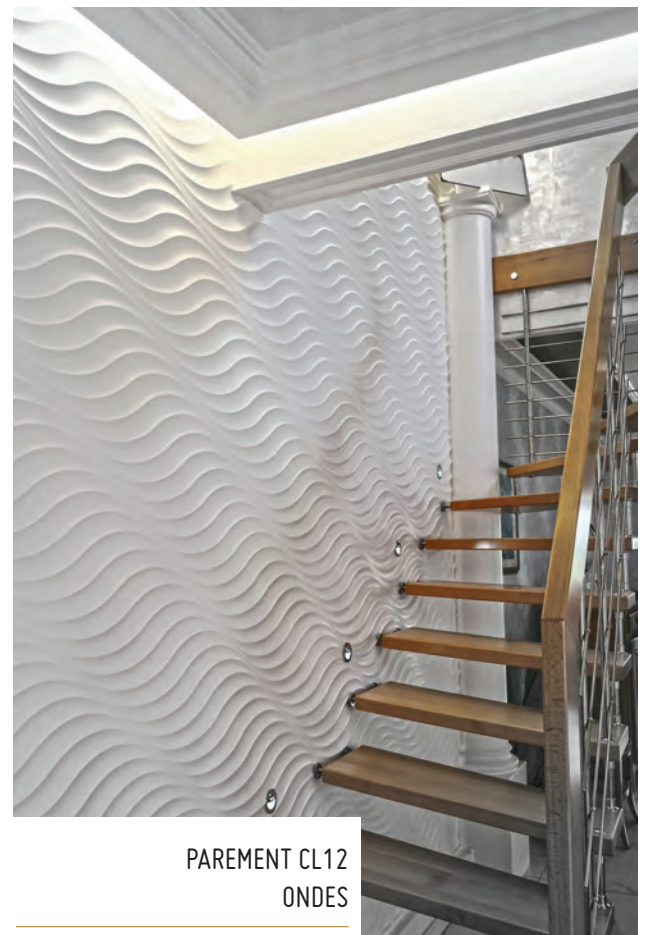
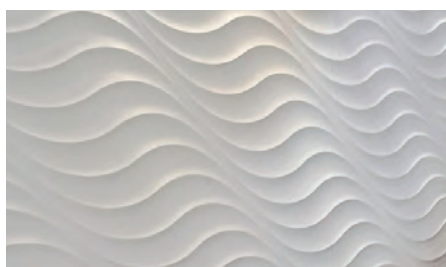

PAREMENT CL12  
 ONDES



\*Le panneau référence CL12 présente un joint creux d'une largeur de 1 cm sur un côté. Pour un résultat sans raccord apparent (bord à bord), ce joint doit être découpé.



CL37  
 Le Flore  
 260 x 123 cm  
 Conditionnement à l'unité.



SOUBASSEMENTS MOULURÉS

# L'HABILLAGE MURAL PAR LAMBRISSAGE

SOUBASSEMENTS MOULURÉS





COMPRENDRE NOS PRODUITS DE SOUBASSEMENTS & ENCADREMENTS MURAUX AFIN DE CHOISIR CELUI QU'IL VOUS FAUT

- 1 - Lambris décaissé
- 2 - Cimaïse
- 3 - Plinthe
- 4 - Intercalaire
- 5 - Plate bande simple côté
- 6 - Plate bande double côté
- 7 - Angle de plate bande
- 8 - Tête de pilastre
- 9 - Pilastre
- 10 - Cimaïse de stylobate
- 11 - Stylobate

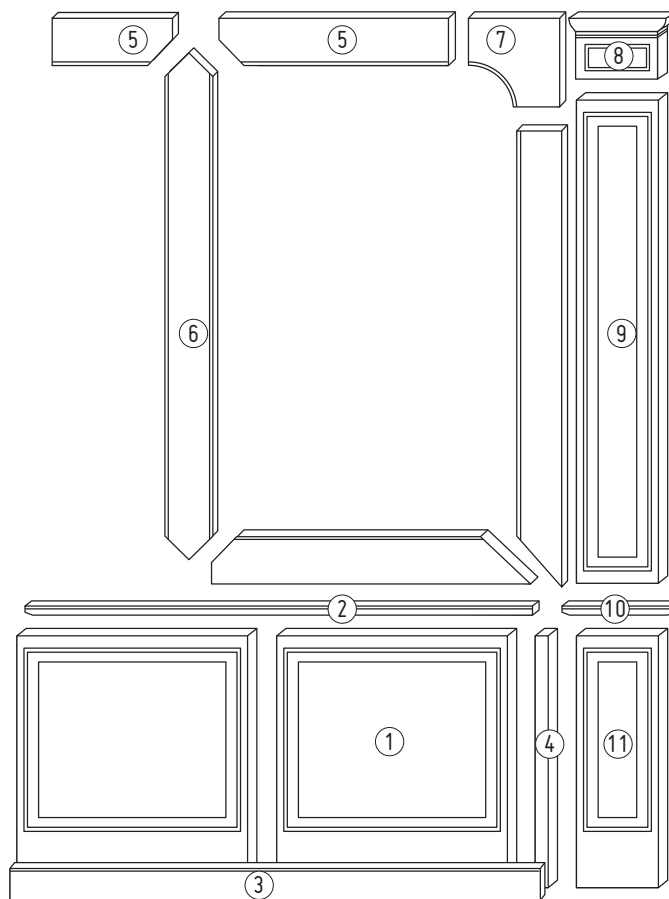

## PLATE BANDE, ANGLES DE PLATE BANDE & CIMAISES

Épaisseur : 1,5 cm

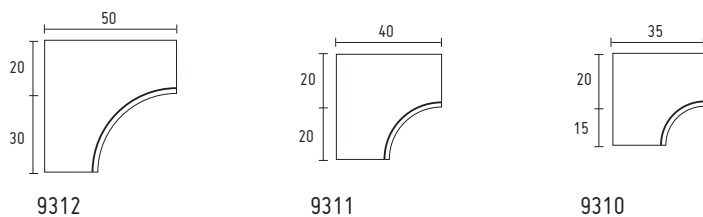

Épaisseur : 1,5 cm

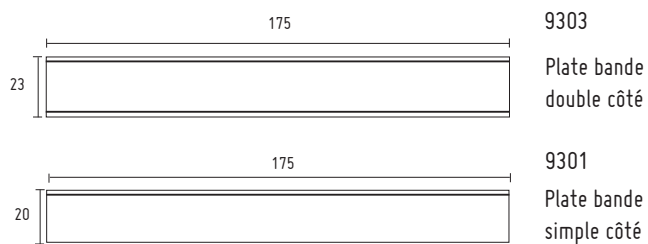

Existe en Plate bande simple étroite 9302

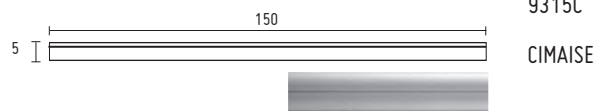

# LAMBRIS DÉCAISSÉS

SOUBASSEMENT 9222



3 Hauteurs disponibles : 55, 75 et 85 cm  
 (Hauteur du lambris sans cimaise)  
 Épaisseur : 2,3 cm

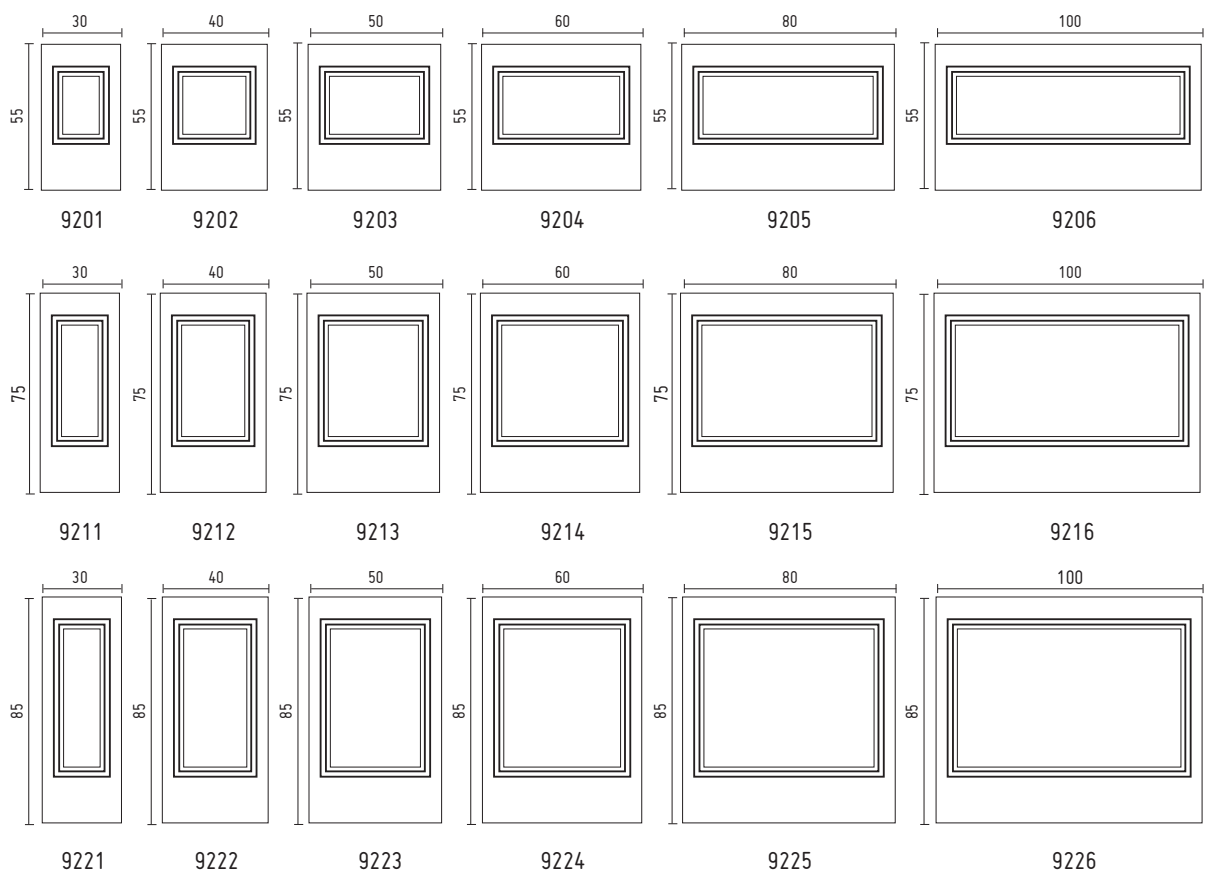

# TÊTES POUR PILASTRES

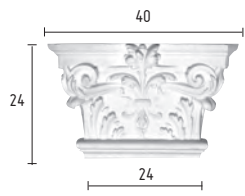

1003

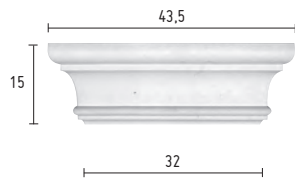

2004

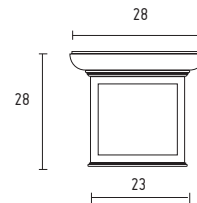

9460

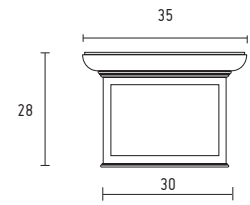

9461

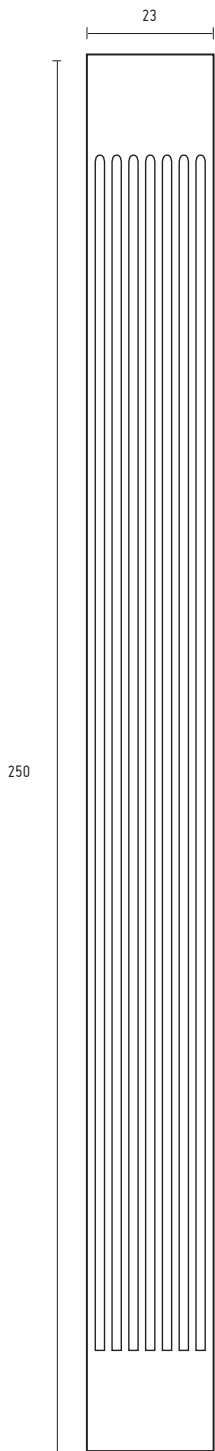

1000

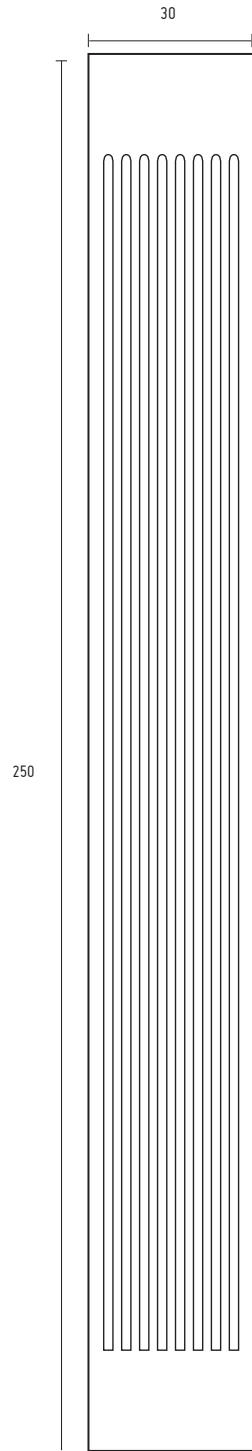

2000

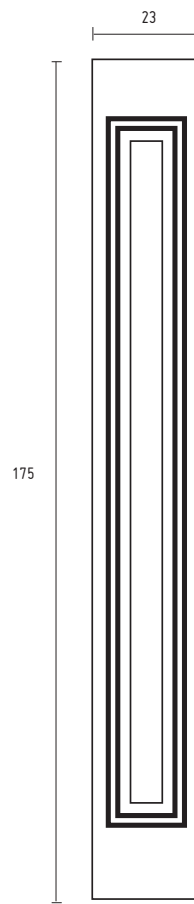

9450

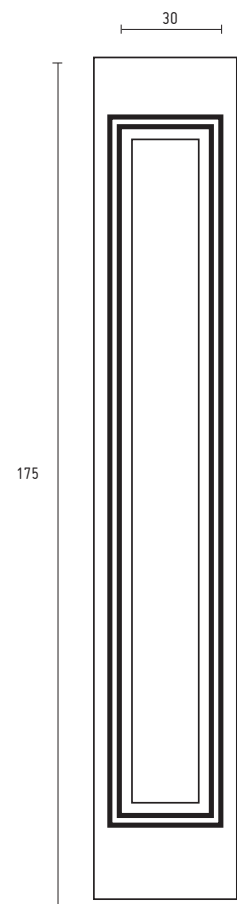

9451



*Retrouvez toutes nos têtes de pilastres, pilastres et socles à la page 113 !*

# INTERCALAIRES, STYLOBATES ÉLÉMENTS DE CIMAISES, PLINTHES

Épaisseur : 7 cm  
Éléments de cimaise

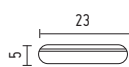

9315.23

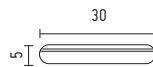

9315.30

Épaisseur : 2 cm  
Intercalaire

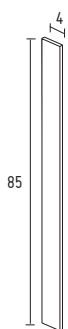

9280

Épaisseur : 4,5 cm  
Stylobates

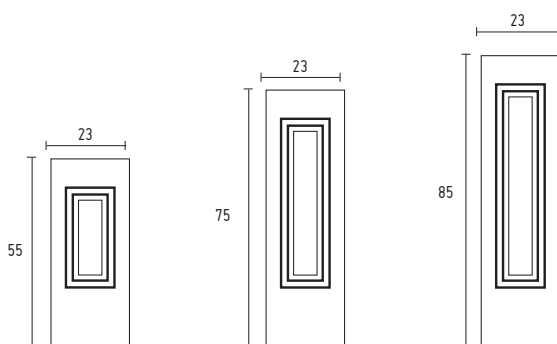

9401

9402

9403

Épaisseur : 4,5 cm  
Stylobates

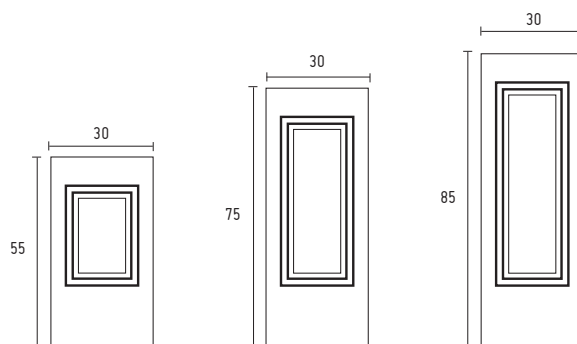

9411

9412

9413



Pensez à composer :  
Découvrez tous nos modèles de plinthes à la page 103  
de notre catalogue !





# NOS AUTRES SOLUTIONS POUR VOS SOUBASSEMENTS

*Une cimaise*



*un panneau*



*une plinthe*



1140C (en 1,50 ml)



1141C (en 1,50 ml)



9315C (en 1,50 ml)



9020 - H 118 x L 70 cm



9021 - H 86 x L 70 cm



9211 - H 75 x L 30 cm



9025 - H 120 x L 32 cm

## Nos autres modèles de cimaises



1101C (en 1,50 ml)

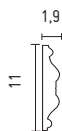

1103C (en 1,50 ml)

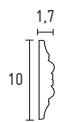

1145C (en 1,50 ml)

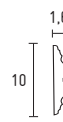

Nos cimaises sont vendues avec des bouts pour des finitions impeccables. Il vous suffit de les couper pour assembler les éléments entre eux !



SDC1 (en 1,20 ml)

Conditionnement en carton de 4 éléments



SDC2 (en 1,20 ml)

Conditionnement en carton de 4 éléments



*Sélectionnez votre profil & choisissez la dimension de votre panneau !*

Profil n°1



Profil n°2



Profil n°3



RÉFÉRENCE DES PANNEAUX			
Dimensions en cm	80x50	55x50	20x50
Profil n°1	9001	9003	9002
Profil n°2	9011	9013	9012
Profil n°3	9031 (83x50)	9033	9032

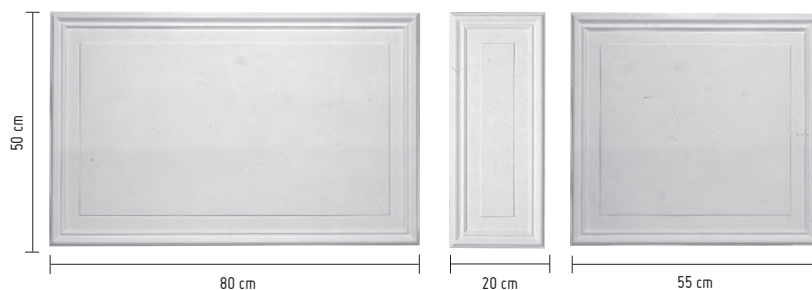

## Nos autres modèles de plinthes

PLIN08 (en 1,50 ml), hauteur 8 cm  
 PLIN10 (en 1,50 ml), hauteur 10 cm  
 PLIN12 (en 1,50 ml), hauteur 12 cm  
 PLIN15 (en 1,50 ml), hauteur 15 cm  
 PLIN20 (en 1,50 ml), hauteur 20,5 cm



Angles sortants :  
 PLIN10A (pour PLIN10)  
 PLIN12A (pour PLIN12)  
 PLIN15A (pour PLIN15)  
 PLINTA (pour PLINT)



PLINT (en 1,50 ml), hauteur 10 cm

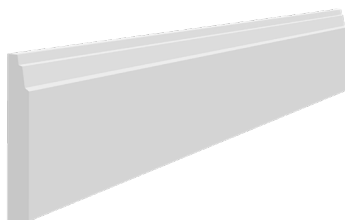

PLIN08M (en 1,50 ml), hauteur 8 cm  
 PLIN10M (en 1,50 ml), hauteur 10 cm



# LES HABILLAGES DE PORTE

## LE CONTEMPORAIN



### HABILLAGE DE PORTE 960.00

3 panneaux imbriqués de 65 x 20 cm.

Convient aux portes de toute largeur.



#### Mise en oeuvre

- Poser la porte sur 2 tréteaux.
- Exécuter un tracé sur la porte pour déterminer l'emplacement exact des panneaux à coller.
- Poncer à l'aide de gros papier de verre pour éliminer les fonds de peinture et rayer au cutter pour faciliter l'accrochage.
- Sur le panneau d'habillage de porte, appliquer de la colle pour carrelage référence 0034 (en 5 kg) ou 0036 (en 1,5 kg) à l'aide d'une spatule à dents ou colle contact.
- Procéder au raclage des bavures, dès que la colle a commencé à faire sa prise.

La finition de ces panneaux vous évitera tout ponçage et préparations diverses avant l'application de la peinture.

# LES CLASSIQUES



HABILLAGÉ DE PORTE 912.73



Habillage de porte 902.73,  
couvre joint 1108,  
fronton de Porte,  
moulure 1156.



Profil n°1



Profil n°2



Profil n°3

RÉFÉRENCES DES DIFFÉRENTS MODÈLES							
TYPE DE PROFIL	LARGEUR DES PORTES						
Profil n°1	63 cm	901.63	911.63	921.63	930.63	940.63	950.63
	73 cm	901.73	911.73	921.73	930.73	940.73	950.73
	83 cm	901.83	911.83	921.83	930.83	940.83	950.83
Profil n°2	63 cm	902.63	912.63	922.63	932.63	942.63	952.63
	73 cm	902.73	912.73	922.73	932.73	942.73	952.73
	83 cm	902.83	912.83	922.83	932.83	942.83	952.83
Profil n°3	63 cm	903.63	913.63	/	933.63	943.63	/
	73 cm	903.73	913.73	/	933.73	943.73	/
	83 cm	903.83	913.83	/	933.83	943.83	/

# LES COUVRE-JOINTS

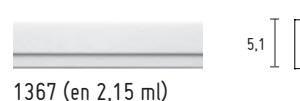
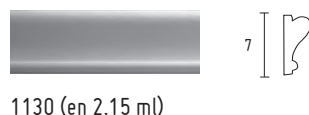
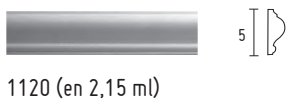
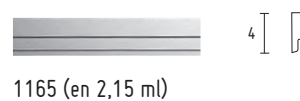
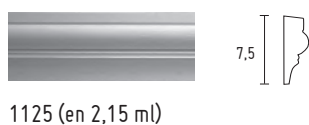
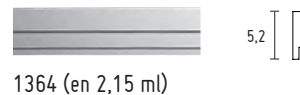
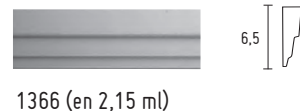
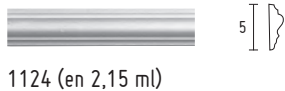

# LES TALONS DE PORTE

TAL12 :  
H 12 cm, L 6 cm, E 2 cm  
TAL14 :  
H 14 cm, L 6 cm, E 2 cm  
TAL17 :  
H 17 cm, L 6 cm, E 2 cm

TALGM  
H 17 cm, L 9 cm, E 3,5 cm  
TALSP  
H 14 cm, L 7,5 cm, E 2,2 cm

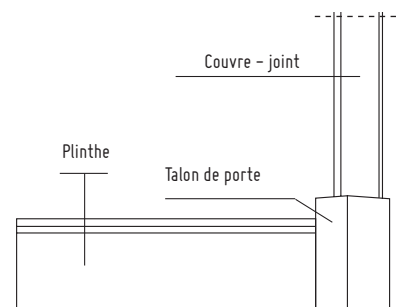

D'autres talons de portes adaptés à vos moulures sont disponibles en magasin. Renseignez-vous auprès de votre conseiller Staff Décor !

# LES FRONTONS



3900 - 101 x 31 cm



3905 - 79,5 x 42  
livré finition plâtre naturel



3902 - 99 x 36 cm



Nos frontons vous sont livrés brut de plâtre. N'hésitez pas à les personnaliser et les adapter aux couleurs de votre intérieur en les peignant !

FRONTON 3903  
© The White House, Cannes



3904 - 100 x 22 cm



3901 - 112 x 30 cm



3903 - 120 x 45 cm

# LES COLONNES



40.06  
24 x 24 x H 11 cm  
40.60, 1/2 chapiteau



40.07  
24 x 24 x H 13 cm  
40.70, 1/2 chapiteau



40.03  
Ø 29,5 cm - H 13 cm  
40.30, 1/2 chapiteau



40.08  
29 x 29 x H 24 cm  
40.80, 1/2 chapiteau



40.09  
24 x 24 x H 8 cm  
40.90, 1/2 chapiteau



40.01  
46 x 46 x H 40 cm  
40.10, 1/2 chapiteau



40.04  
30 x 30 x H 10 cm  
40.40, 1/2 chapiteau



40.07A  
29 x 29 x H 13 cm  
40.70A, 1/2 chapiteau



20.05  
H 205 cm  
Ø haut 14 cm  
sous collerette  
Ø base / 19 cm

20.55  
1/2 col.  
H 205 cm

Socle :  
25 x 25 x 30 cm



20.04  
H 205 cm  
Ø haut 14 cm  
sous collerette  
Ø base / 19 cm

20.54  
1/2 col.  
H 205 cm

Socle :  
25 x 25 x 30 cm



20.02  
H 220 cm  
Ø haut 20 cm  
sous collerette  
Ø base / 26 cm

20.52  
1/2 col.  
H 220 cm

Socle :  
35 x 35 x 50 cm

*Les dimensions de nos fûts vous sont données hors socle.*



## Mise en oeuvre

- Pour habiller un poteau nos colonnes sont livrées par deux 1/2 colonnes à assembler
- L'ajustement de la colonne à la hauteur désirée se fait par réduction de la hauteur du socle ou encore de son fût.

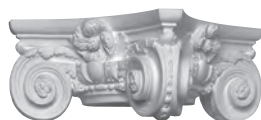

40.02  
41 x 41 x H 16,5 cm  
40.20, 1/2 chapiteau



40.01  
46 x 46 x H 40 cm  
40.10, 1/2 chapiteau



40.05  
34 x 34 x H 10 cm  
40.50, 1/2 chapiteau

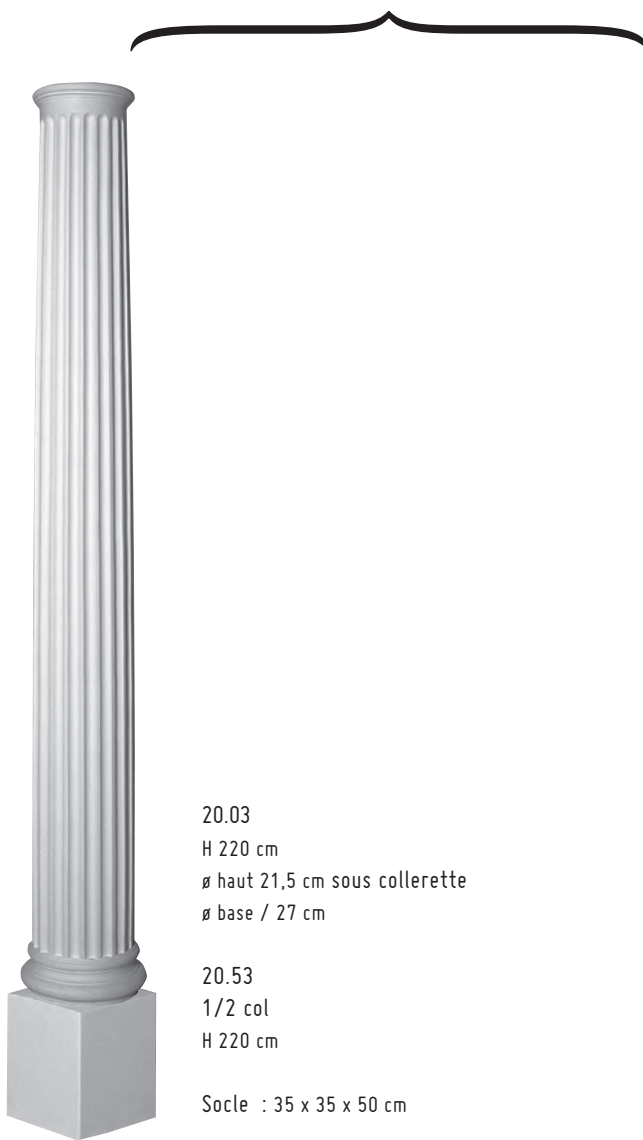

20.03  
H 220 cm  
ø haut 21,5 cm sous collerette  
ø base / 27 cm

20.53  
1/2 col  
H 220 cm

Socle : 35 x 35 x 50 cm



20.01  
H 220 cm  
ø 25 cm

20.51  
1/2 col.  
H 220 cm







Socle : 35 x 35 x 50 cm

*Les dimensions de nos fûts vous sont données hors socle.*



# Composez vos colonnes !

A l'aide de notre tableau de correspondances, choisissez les éléments qui s'adapteront à votre intérieur !

	DIAMETRE	DIMENSIONS colonne entière H x L x l	LISSES			HAUTEUR (en cm)	CANNELEES					
			½	ENTIERE			½	ENTIERE				
<b>CHAPITEAUX</b> 	Ø 15	11x24x24	40.60	40.06	<b>CHAPITEAUX</b> 		40.60	40.06				
	Ø 20	10x30x30	40.40	40.04			40.40	40.04				
	Ø 25	10x34x34	40.50	40.05			40.50	40.05				
	Ø 30	11,5x40x40	41.51	41.01			41.51	41.01				
	Ø 35	12,5x46x46	41.55	Nous consulter			41.55	Nous consulter				
	Ø 40	11x52x52	41.52	41.02			41.52	41.02				
	Ø 50	13x63x63	41.53	41.03			41.53	41.03				
<b>FÛTS LISSES</b> 	Ø 10	250	20.58	20.08	<b>FÛTS CANNELES</b> 	250	20.56	20.06				
	Ø 15	300	30.52	30.02		250	31.51	31.01				
	Ø 20	300	30.53	30.03		300	31.52	31.02				
	Ø 25	300	30.54	30.04		300	31.53	31.03				
	Ø 30	300	30.55	30.05		300	31.54	31.04				
	Ø 35	300	30.56	30.06		300	-	-				
	Ø 40	300	30.57	30.07		300	-	-				
	Ø 50	300	30.58	30.08		300	-	-				
	Ø 60	300	30.59	30.09		300	-	-				
	Ø 70	300	30.60	30.10		300	-	-				
	Ø 75	300	30.61	30.11		300	-	-				
	Ø 80	300	30.62	30.12		300	-	-				
	Ø 90	300	30.63	-		300	-	-				
<b>SOCLES &amp; COLLERETTES</b> 		DIM. ENTIER	COLLERETTE	SOCLE	COLLERETTE	SOCLE	<b>SOCLES &amp; COLLERETTES</b> 	Hauteur	COLLERETTE	SOCLE	COLLERETTE	SOCLE
	Ø 10	14,5x14x14	20.56B	20.56S	20.06B	20.06S		14,5	20.56B	20.56S	20.06B	20.06S
	Ø 15	39x25x25	45.51			45.01		39	45.51			45.01
	Ø 20	31x32x32	45.52			45.02		31	45.52			45.02
	Ø 25	61x35x35	45.53			45.03		61	45.53			45.03
	Ø 30	41x42x42	45.54			45.04		41	45.54			45.04
	Ø 35	Nous consulter	45.55			45.05		Nous consulter	45.55			45.05
	Ø 40	Nous consulter	45.56			45.06		Nous consulter	45.56			45.06
Ø 50		45.57			45.07		45.57			45.07		

Dimensions en cm



Les socles peuvent être coupés en hauteur.



FÛT 20.02  
CHAPITEAU 40.01  
PAGE 108

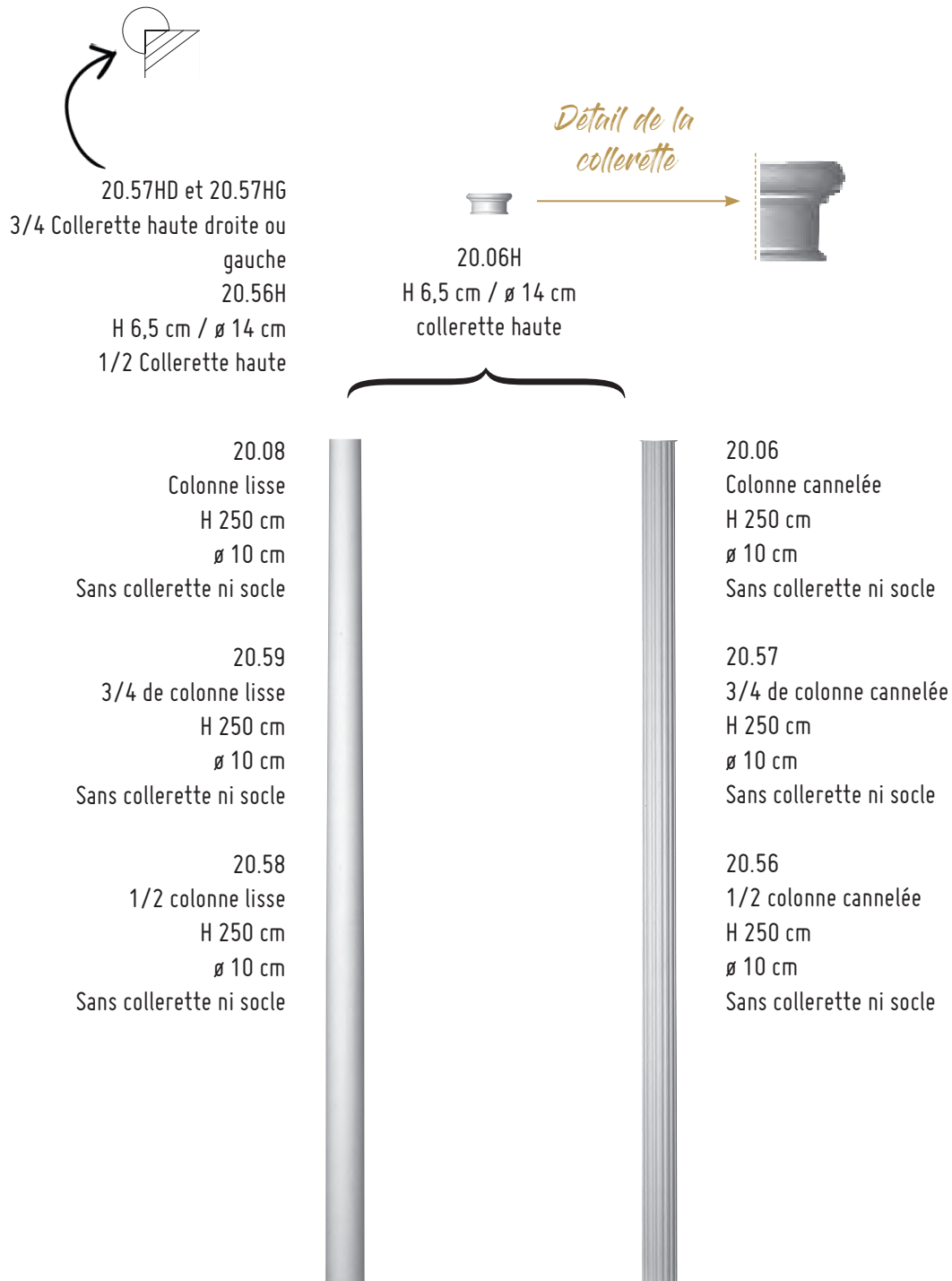

Socle & colerette basse



Références colerettes

20.06B / H 4,5 cm / ø 13 cm  
Colerette basse

20.57BD  
3/4 Colerette basse droite

20.57BG  
3/4 Colerette basse gauche

20.56B / H 4,5 cm / ø 13 cm  
1/2 Colerette basse

Références socles

20.06S / 14 x 14 x 10 cm  
Socle

20.57SD  
3/4 Socle droit

20.57SG  
3/4 Socle gauche

20.56S / 14 x 7 x 10 cm  
1/2 Socle



Mémo mise en oeuvre

Attention : Les socles et colerettes basses sont dissociés.

Aussi pour toutes vos commandes, veuillez à bien sélectionner toutes les références nécessaires.



2001  
H 8 x L 40 x E 6 cm



2004  
H 15 x L 43,5 x E 10 cm



2000  
H 250 cm x L 30 cm x E 3 cm



2020  
H 244 cm x L 30 cm x E 2,5 cm



2005  
H 30 cm x L 39 cm x E 7 cm



# LES PILASTRES



1001  
H 8 x L 33,5 x E 6 cm



1002  
H 34 x L 36 x E 10 cm



1003  
H 24 x L 40 x E 11 cm



1004  
H 15 x L 37 x E 10 cm



1055  
H 28,5 x L 34,5 x E 10 cm



0999  
H 17 x L 41 x E 12 cm



1000  
H 250 cm x L 23 cm x E 3 cm



1025  
H 250 cm x L 23 cm x E 3 cm



Notre fleur de  
trumeau existe  
aussi seule :  
3906



1050  
H 250 cm x L 23 cm x E 3,5 cm



1005  
Pour pilastres 1000, 1025, 1050 et 2031  
H 30 cm x L 31 cm x E 7 cm



0952  
H 15,5 x L 26 x E 6,6 cm



0951  
H 8 x L 29,5 x E 6 cm

*Personnalisez vos pilastres avec nos ornements centrales !*



2030M : Rectangle central pour pilastre 2030



2031C : Cercle central pour pilastre 2031



2031M : Rectangle central pour pilastre 2031

*égale-  
ment  
compatible*



Ce pilastre existe également en 40 cm de largeur pour une hauteur de 250 cm sous la référence 3000.



0950  
H 250 cm x L 19 cm x E 3,5 cm

2030  
H 170 cm x L 17 cm x E 1,5 cm



0955  
H 24,5 cm x L 24,5 cm x E 6 cm

Existe aussi  
2031  
H 170 cm x L 23 cm x E 1,5 cm



0761  
H 9 x L 12 x E 4 cm



0801  
H 8 x L 22,5 x E 4,5 cm



0802  
H 18 x L 22,5 x E 6 cm



0803  
H 9 x L 17 x E 4 cm



0762  
H 4,5 x L 13 x E 4 cm



0804  
H 15 x L 26 x E 9 cm



0806  
H 5,5 x L 19 x E 5 cm



0760  
H 250 cm x L 7 cm x E 1,5 cm



Autre modèle de pilastre  
cannelé Réf. 0780  
(H 250 cm, L 10 cm, E 1,5 cm)  
avec têtes 0781 ou 0782  
et socle 0785.



0800  
H 250 cm x L 12 cm x E 2 cm



0765  
H 17 cm x L 9,5 cm x E 3 cm



0805  
H 17,5 cm x L 14,5 cm x E 3 cm

# LES BALUSTRES



0901  
H 9,5 x L 22 x E 4,5 cm



0902  
H 14,5 x L 26 x E 7 cm



0903  
H 15,5 x L 31 x E 9 cm



0904  
H 8 x L 26 x E 5 cm



0900  
H 250 cm x L 17 cm x E 2,5 cm



0905  
H 21 cm x L 20 cm x E 4 cm

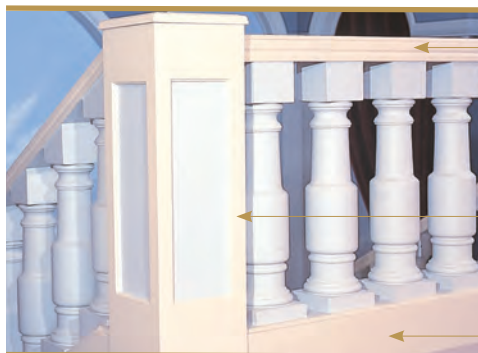

7004  
Main courante  
L 14,5 x 7 cm  
(en 2 ml)

7006  
Poteau  
25 x 25 x H 95 cm

7005  
Socle  
L 23,5 x 26 cm  
(en 2 ml)



Balustre 1

7001  
H 60 cm  
Base  
15,5 x 15,5 cm



Balustre 3

7003  
H 80 cm  
Base  
16,5 x 16,5 cm



Balustre 2

7002  
H 60 cm  
Base  
15,5 x 15,5 cm



MOD23  
PAGE 124

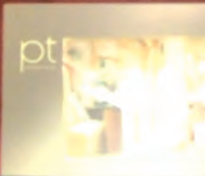







M0E45  
PAGE 124

# AGENCEMENTS



	<b>MODULOSTAFF &amp; NICHES</b>	<b>122</b>
	ÉLÉMENTS CREUX POUR MODULO	124
	ÉLÉMENTS D'ANGLES EN QUART DE ROND POUR MODULO	125
	ÉLÉMENTS PLEINS POUR MODULO	127
	LES NICHES CONTEMPORAINES	128
	LES NICHES CLASSIQUES	129
	LES NICHES GRANDES DIMENSIONS	129
	<b>LES TÊTES DE LIT</b>	<b>130</b>
	TÊTE DE LIT OCÉAN	130
	TÊTE DE LIT CAPITONS	130
	TÊTE DE LIT SAHARA	131
	<b>LES MEUBLES EN STAFF</b>	<b>132</b>
	MEUBLES TV	132
	BIBLIOTHÈQUES	133
	MEUBLES BIBLIOTHÈQUES	134
	MEUBLES ET DÉCORS DE SALLE DE BAINS	136
	<b>PASSAGES ET MEUBLES DE PASSAGE</b>	<b>138</b>
	LES PASSAGES CLASSIQUES	140
	LES VOÛTES	141
	LES PASSAGES CONTEMPORAINS	142
	LES PASSAGES ÉCLAIRANTS	143
	LES MEUBLES DE PASSAGE	144
	<b>CACHE RADIATEURS</b>	<b>146</b>
	LES CONTEMPORAINS	148
	LES CLASSIQUES	149

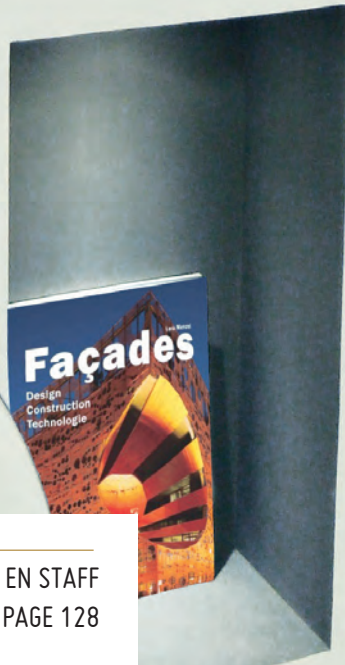

NICHES EN STAFF  
PAGE 128

# MODULOSTAFF & NICHES

MEUBLES MODULOS  
PAGE 124

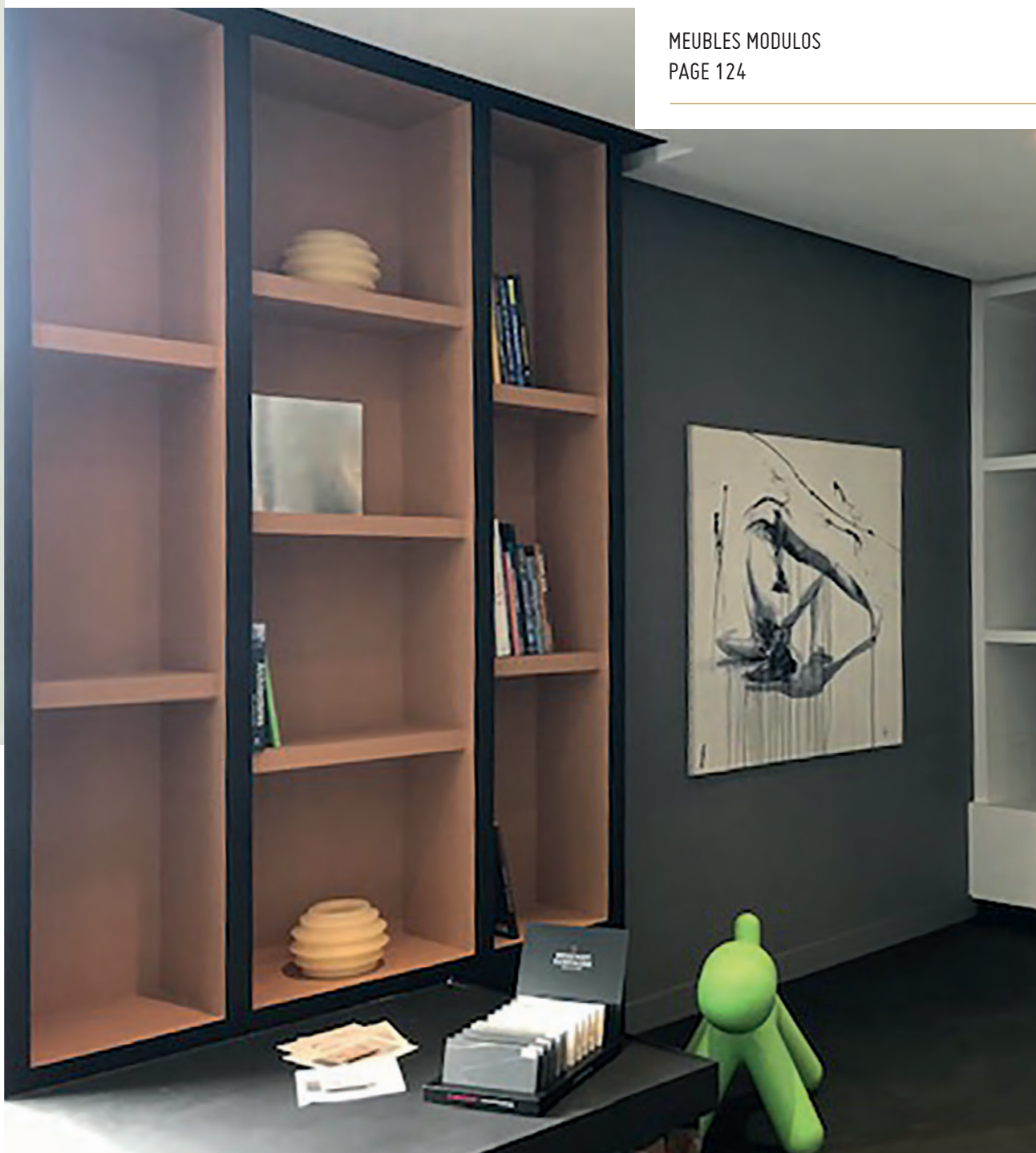



Simplifiez-vous la vie !

Faites passer vos gaines techniques dans les éléments creux pour l'alimentation de vos spots et LEDS ou votre matériel HIFI !

## MODULEZEN FONCTION DE VOS BESOINS !

Associez nos accessoires à nos éléments creux et obtenez un meuble sur-mesure à votre image !

## ÉLÉMENTS CREUX POUR MODULO

Montants verticaux (1)			
Réf.	Hauteur	Profondeur	Épaisseur
MOD23	250 cm	36 cm	5 cm
MOD24	250 cm	36 cm	7 cm
MOD25*	250 cm	36 cm	7 cm

\* 4 faces lisses

Éléments horizontaux (étagères) (2)			
Réf.	Longueur	Profondeur	Épaisseur
MOE45	37,5 cm	35,5 cm	7 cm
MOE60	52,5 cm	35,5 cm	7 cm
MOE90	82,5 cm	35,5 cm	7 cm
MOE120	112,5 cm	35,5 cm	7 cm

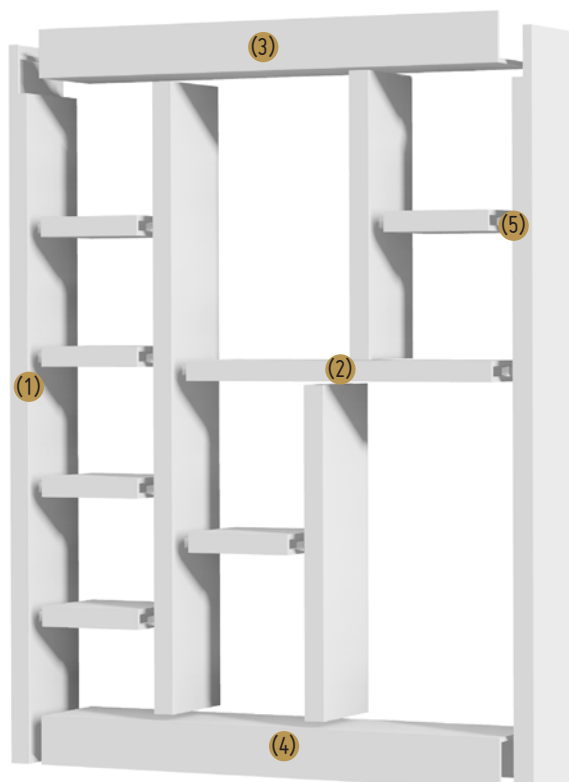

## ACCESSOIRES OPTIONNELS

Casquette (3) MODC : hauteur : 17 cm, profondeur 36 cm en élément de 2 ml.

Socle (4) MODS : hauteur : 17 cm, profondeur 36 cm en élément de 2 ml.

Glissières (5) pour la fixation des étagères (vendues par 10 unités), pré-perçées, à visser et à coller à l'enduit.

MOD06 (pour MOD24 et MOD25)

MOD05 (pour MOD23)

# ÉLÉMENTS D'ANGLE EN QUART DE ROND POUR MODULO



**Mise en oeuvre :**

L'étagère MOA24, le socle MOAS et la casquette MOAC permettent de créer des angles arrondis dans les compositions modulostaff de la gamme MOD24. De même rayon que la profondeur des éléments MOD24, leur pose sur glissières suit le même principe que pour les éléments droits.

ETAGERE (MOA23)

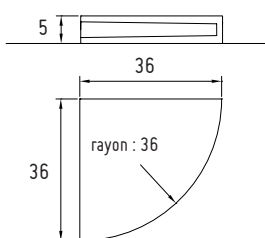
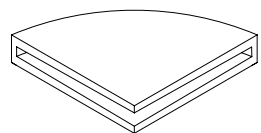

ETAGERE (MOA24)

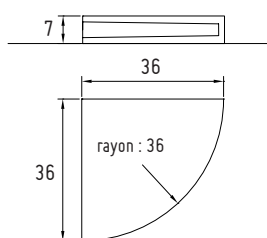
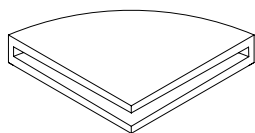

SOCLE (MOAS)

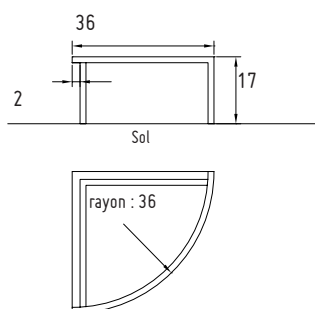
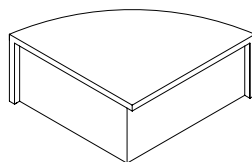

CASQUETTE (MOAC)

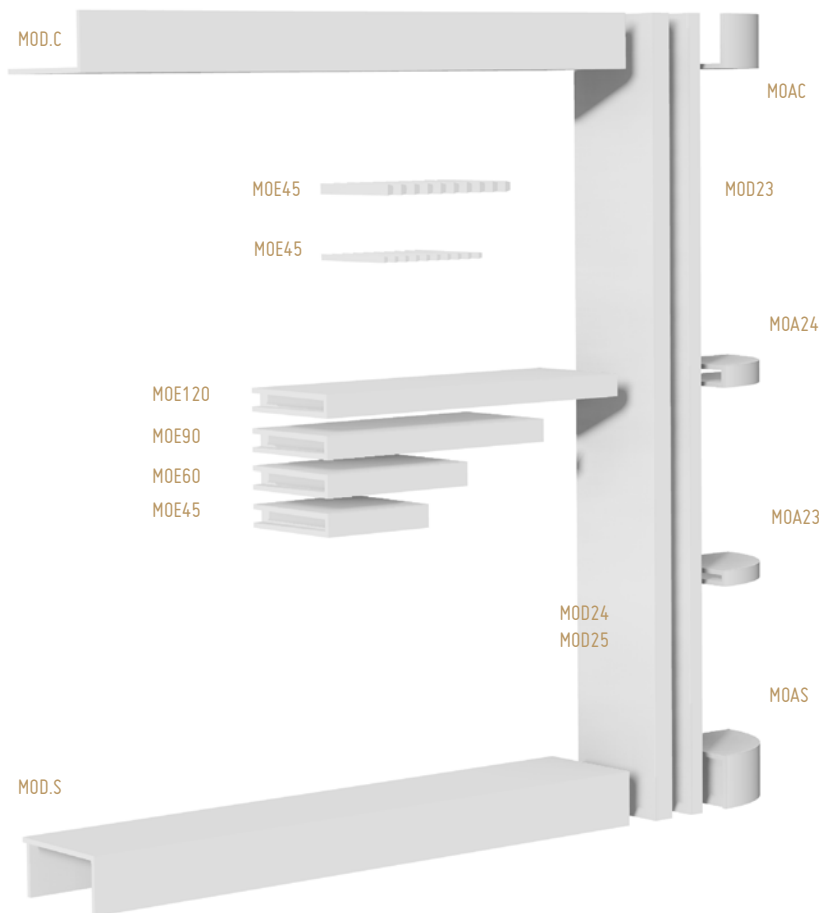
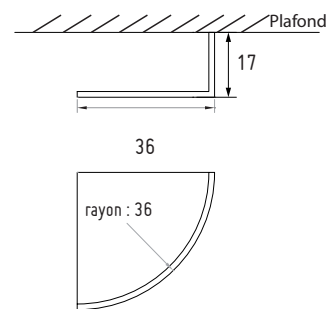
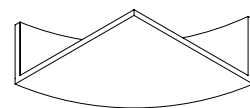

Nous vous proposons des solutions de plinthes cintrées pour vos modulos: MOAPLIN10, MOAPLIN10M, MOAPLINT



## COMMENT COMPOSER ?

Deux exemples pour tout comprendre et surtout s'inspirer !

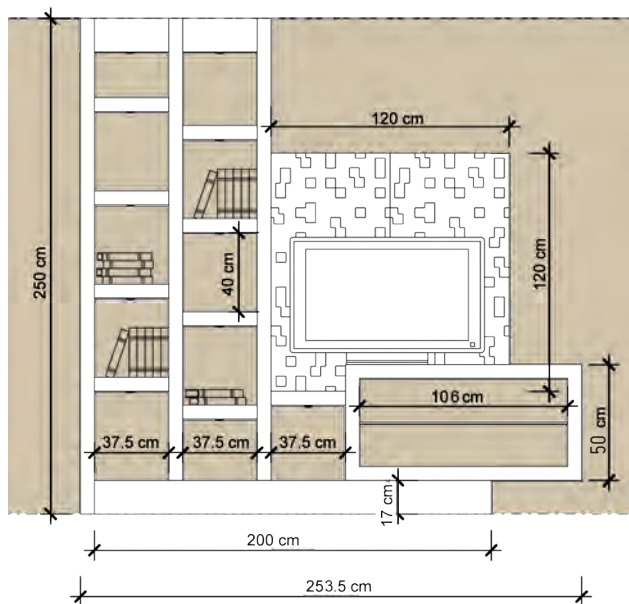

Composition pour TV et bibliothèque réalisée à partir de la gamme Modulostaff MOD24.



Réalisée à partir de la gamme Modulostaff MOD24, la composition "Quinconce" offre une solution de rangement contemporaine et rythmée. Accentuez le jeu de rythme grâce à l'alternance des éclairages.

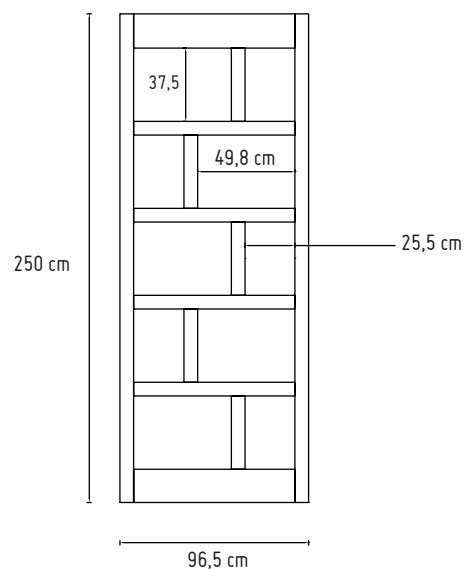

# ÉLÉMENTS PLEINS POUR MODULO

Voici un concept de composants en staff en 5 cm d'épaisseur pour réaliser vos étagères.  
Tous les éléments sont étudiés pour vous faciliter la pose.

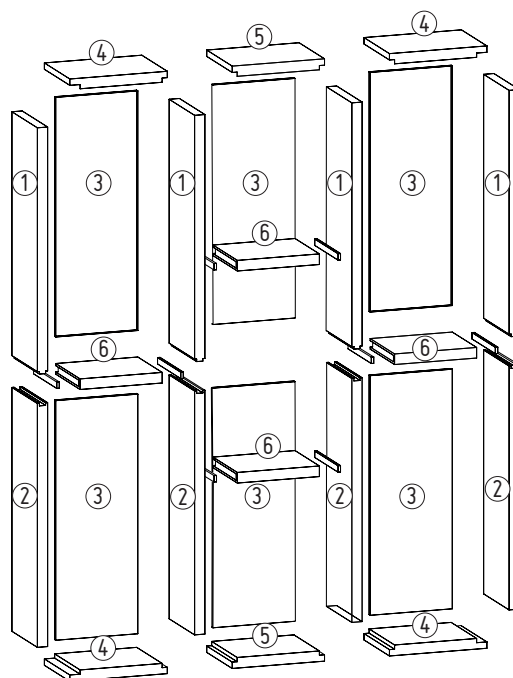
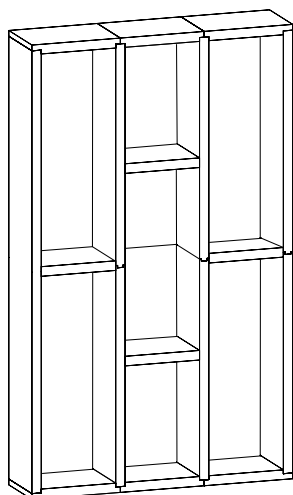

- 1 - M05-H115 : Montant (partie haute) 115 x 35 x 5 cm
- 2 - M05-B115 : Montant (partie basse) 115 x 35 x 5 cm
- 3 - M05-F0398 : Fond de meuble 111 x 39,8 x 1,5 cm
- 4 - M05-245 : Socle et/ou Casquette «Latéral» 47,3 x 35 x 5 cm
- 5 - M05-242 : Socle et/ou Casquette «Central» 44,8 x 35 x 5 cm
- 6 - M05-ET398 : Etagère 39,8 x 33,5 x 5 cm
- M05-545 : Socle / Casquette 50 x 35 x 5 cm (dans le cas d'un agencement avec une seule niche)
- MOD05 : glissières pour fixation des étagères (vendues par 10 unités)



# LES NICHES CONTEMPORAINES



0714 / 40 cm x 20 cm x P 20 cm  
0734 / 50 cm x 25 cm x P 20 cm  
0744 / 60 cm x 30 cm x P 20 cm



0724 / 40 cm x 40 cm x P 20 cm



0726 / Ø 40 cm x P 20 cm

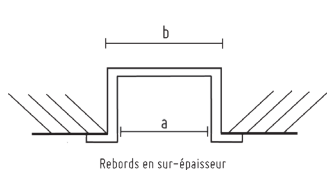

Niche à rebord



*OU*

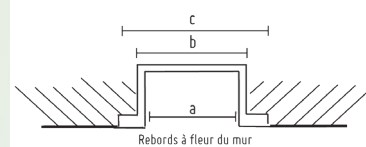
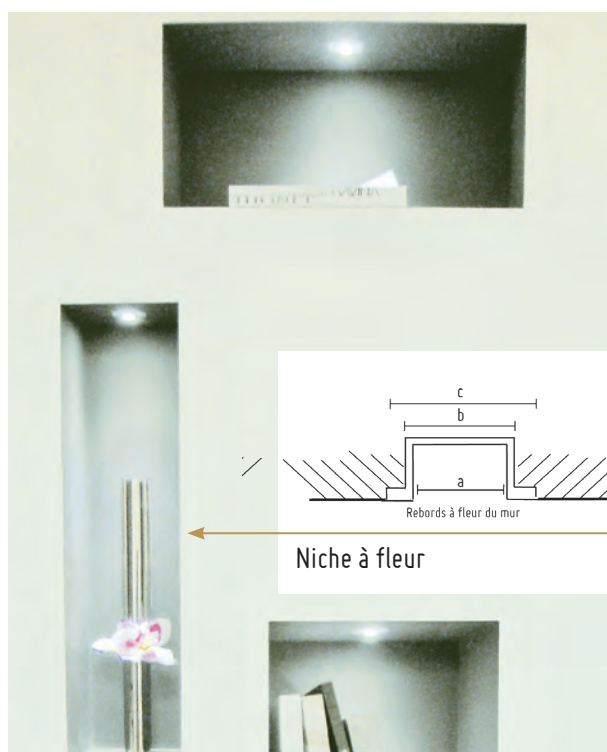

Niche à fleur

## NICHES RECTANGULAIRES ET CARRÉES

Réf.	Côtés intérieurs (a)			Côtés extérieures d'encastrement (b)			Côtés extérieures hors tout (c)		
	Hauteur	Largeur	Profondeur	Hauteur	Largeur	Profondeur	Hauteur	Largeur	Profondeur
0714	400	200	200	430	230	215	500	300	235
0724	400	400	200	430	430	215	500	500	235
0734	500	250	200	530	280	215	600	350	235
0744	600	300	200	630	330	215	700	400	235

Cotation en mm

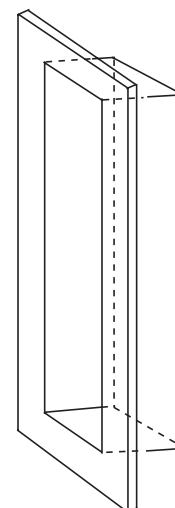

# LES NICHES CLASSIQUES «CUL DE FOUR»

NICHES STANDARD						
Réf.	Côtés intérieurs (a)			Côtés extérieurs d'encastrement (b)		
	Hauteur	Largeur	Profondeur	Hauteur	Largeur	Profondeur
0710	300	150	75	320	170	85
0712	400	200	100	420	220	110
0732	500	250	125	520	270	135
0742	600	300	150	620	320	160

Cotation en mm

NICHES MODULABLES EN HAUTEUR		
Côtés intérieurs (a)		
Hauteur	Largeur	Profondeur
1020	400	200
1750	500	250
1800	600	300
1450	700	350
2000	800	400
2000	900	450
2000	1000	500

Cotation en mm

Toutes ces niches sont modulables en hauteur (fabrication spéciale sur devis). Pour déterminer les cotes d'encastrement ajoutez environ 30 ou 40 mm.

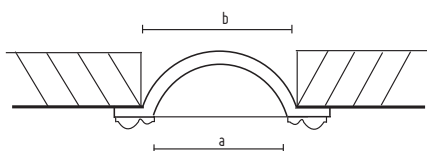

NICHE  
CUL DE FOUR

# LES NICHES GRANDES DIMENSIONS

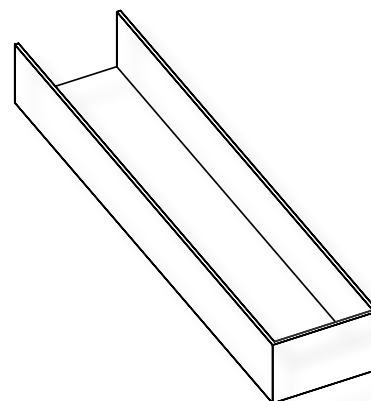
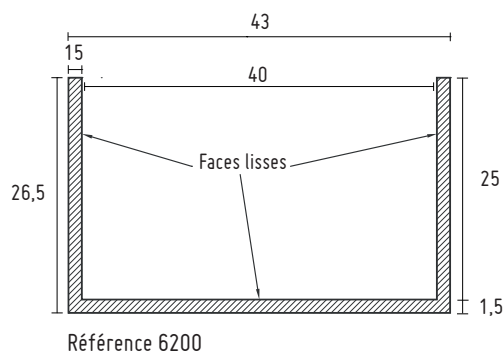
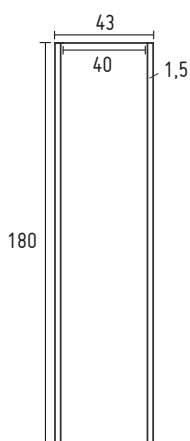

## TÊTE DE LIT OCEAN

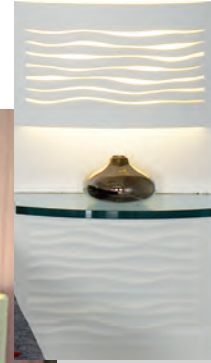
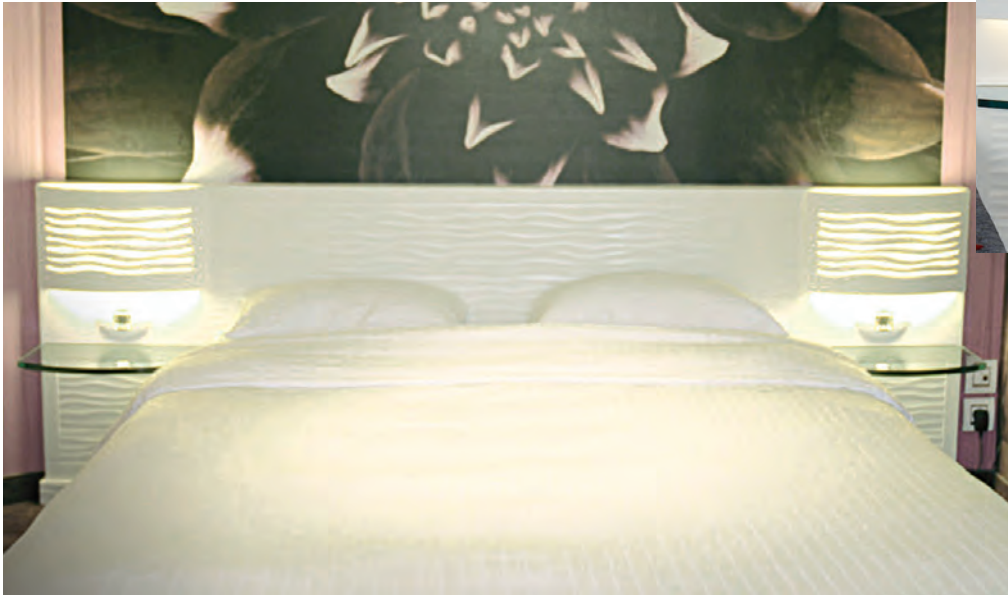

Deux largeurs standards de la partie centrale sont proposées :

- 160 cm (conseillée pour un lit de 140 cm) : T.OCEAN160
- 180 cm (conseillée pour un lit de 160 cm) : T.OCEAN180

Finition en plâtre naturel, prêt à peindre.  
Pose par collage à l'enduit cellulosique.

Autres dimensions sur devis. Luminaires et ampoules inclus.

## TÊTE DE LIT CAPITONS



Deux largeurs standards de la partie centrale sont proposées :

- 165 cm (conseillée pour un lit de 140 cm) : T.CAPITON165
- 180 cm (conseillée pour un lit de 160 cm) : T.CAPITON180

Finition en plâtre naturel, prêt à peindre.  
Pose par collage à l'enduit cellulosique.

Autres dimensions sur devis. Luminaires et ampoules non inclus.

# TÊTE DE LIT SAHARA

## Dimensions

Trois largeurs standards de la partie centrale sont proposées :

- 240 cm (conseillée pour lit de 140 cm) : T.SAHARA140
- 260 cm (conseillée pour lit de 160 cm) : T.SAHARA160
- 280 cm (conseillée pour lit de 180 cm) : T.SAHARA180

> Hauteur : 130 cm

> Profondeur : 8 cm (hors chevets)

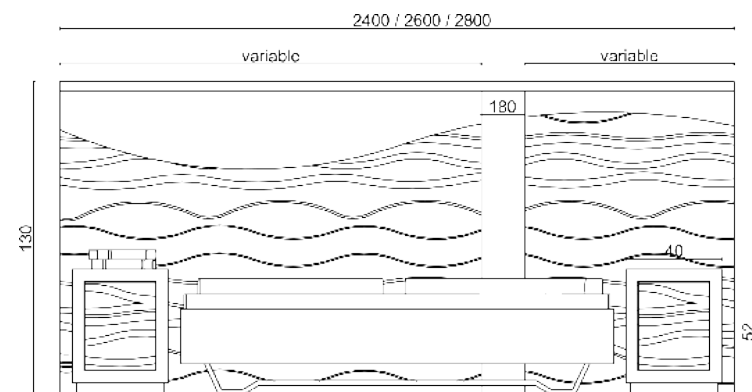

## Équipement

- > 3 éléments en staff
- > Ruban LED blanc chaud ou blanc froid
- > Alimentation A.OT20/24
- > 2 rails de 2ml AA-R1707 et déflecteur opaque.

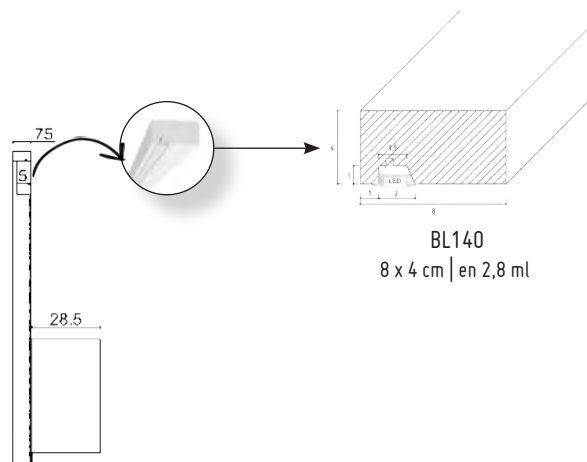

## Option chevet :

> CHEVET1 (chevet avec étagère en verre),

Profondeur totale 28,5 cm

> CHEVET2D (chevet avec porte droite),

Profondeur totale 28,5 cm

> CHEVET2G (chevet avec porte gauche),

Profondeur totale 28,5 cm

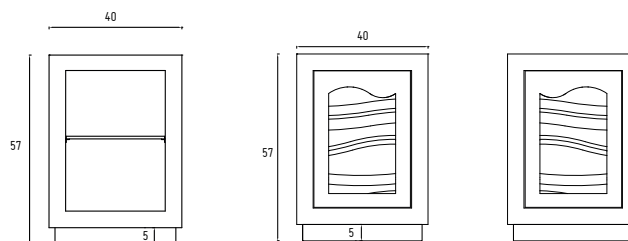

Lorsque l'option chevet est demandée, les réservations nécessaires à la pose sont créées en atelier.



## MEUBLES TV CONTEMPORAINS

Le Meuble TV contemporain est composé de deux éléments. L'élément supérieur est posé sur celui du dessous en fonction de l'écartement souhaité.

Nous proposons 4 dimensions d'étagères en verre :

44,5 cm, réf. 22160.445

54,5 cm, réf. 22160.545

60,5 cm, réf. 22160.605

67,5 cm, réf. 22160.675

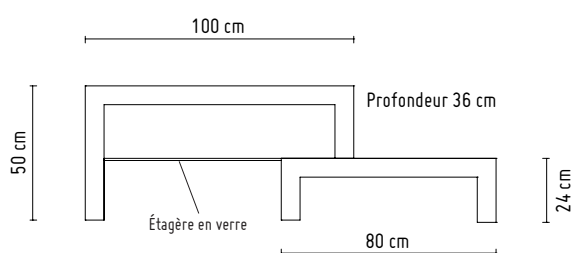

Meuble TV de style contemporain composé de quatre éléments en staff pré-monté (3 niches et un socle) à assembler par collage. Finition des éléments : plâtre naturel prêt à peindre.



Mise en oeuvre :  
Assemblage par simple collage.

# MEUBLES TV CLASSIQUES

MEUBLES TÉLÉ									
	1 Niche + TV		TV + 1 Niche		1 Niche + TV + 1 Niche		2 Niches + TV + 2 Niches		
Dimensions plateau en cm	191 x 44,5 avancée TV 64		191 x 44,5 avancée TV 64		248 x 44,5 avancée TV 64		362 x 44,5 avancée TV 64		
Hauteur meuble complet	248*		248*		248*		248*		
Référence colonnes cannelées	5001		5002		5003		5004		
Référence colonnes lisses	5011		5012		5013		5014		
Option accolée à un mur **	Gauche	Droit	Gauche	Droit	Gauche	Droit	Gauche	Droit	
Référence colonnes cannelées	5021 G	5021 D	5022 G	5022 D	5023 G	5023 D	5024 G	5024 D	
Référence colonnes lisses	5031 G	5031 D	5032 G	5032 D	5033 G	5033 D	5034 G	5034 D	

\* Possibilité d'adapter le meuble pour des hauteurs jusqu'à 300 cm (fabrication spéciale sur devis). Possibilité d'augmenter le nombre de niches du meuble TV (niche standard 57 x 44,5 cm). Les étagères en verre et les spots sont fournis avec les meubles. Étagères en verre : une par niche partie basse, trois par niche partie haute, une par niche TV. Spots : un par niche, deux par niche TV.

\*\* Le côté droit ou gauche accolé au mur est déterminé en regardant le meuble de face.

# LES BIBLIOTHÈQUES

Les bibliothèques sont composées de une ou plusieurs niches en staff de dimensions standards, livrées en kit, dont les éléments sont ajustés, collés à l'enduit lors du montage et prêts à peindre.

STAFF DÉCOR propose deux modèles de niches :

- Niche décorée par des colonnes cannelées
- Niche décorée par des pilastres

Une fois peintes, les bibliothèques s'intègrent harmonieusement dans votre décoration.

BIBLIOTHÈQUES AVEC PILASTRES				
	1 Niche	2 Niches	3 Niches	1 Niche supplémentaire**
Dimensions du socle en cm	88 x 33	148 x 33	208 x 33	60 x 33
Hauteur meuble complet	260*	260*	260*	260*
Référence	30061	30062	30063	30069





\* Possibilité d'adapter la bibliothèque à différentes hauteurs (fabrication spéciale sur devis).

\*\* Possibilité d'augmenter le nombre de niches de la bibliothèque (niche standard).

Les étagères en verre, les spots ainsi que la corniche sont proposés en option.



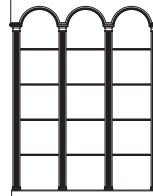

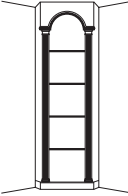
BIBLIOTHÈQUES AVEC COLONNES					
					
	1 Niche	2 Niches	3 Niches	1 Niche supplémentaire**	1 Niche d'angle***
Dimensions du socle en cm	70 x 32	130 x 32	190 x 32	60 x 32	80,5 x 80,5
Hauteur meuble complet	260*	260*	260*	260*	260*
Référence	30051	30052	30053	30059	30054

\* Possibilité d'adapter la bibliothèque à différentes hauteurs (fabrication spéciale sur devis).

\*\* Possibilité d'augmenter le nombre de niches de la bibliothèque (niche standard).

\*\*\* Possibilité d'accoler des niches standards de chaque côté de la niche d'angle.

Les étagères en verre, les spots ainsi que la corniche sont proposés en option.

## LES MEUBLES BIBLIOTHÈQUES

Comme les bibliothèques, le mobilier présenté ci-après, est constitué d'un ou plusieurs modules standards, livrés en kit, prêts à coller et à peindre.



Les éléments bas du mobilier STAFF DECOR, y compris les portes, sont fabriqués dans un matériau très résistant, constitué d'un mélange de plâtre, de fibre de verre et de résine, que nous avons appelé Résistaff (PMGRG - Norme EN.VF13815).

Les tableaux ci-après, présentent les références des éléments standards selon les options suivantes :

- colonnes lisses ou cannelées.

- meuble accolé à un mur sur son côté gauche ou droit, le côté droit ou gauche étant défini en regardant le meuble de face.

Ce système permet également la réalisation d'un meuble bibliothèque combinant des niches simples et d'angle (nous consulter pour la référence).

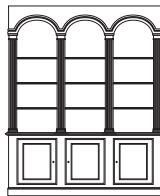
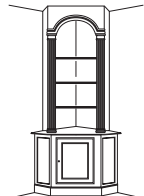
MEUBLES BIBLIOTHÈQUES									
									
	1 Niche		2 Niches		3 Niches		1 Niche d'angle		
Dimensions plateau en cm	79 x 44		136 x 44		193 x 44		90 x 90		
Hauteur meuble complet	248*		248*		248*		248*		
Référence colonnes cannelées	5041		5042		5043		5044		
Référence colonnes lisses	5051		5052		5053		5054		
Option accolée à un mur	Gauche	Droit	Gauche	Droit	Gauche	Droit	Gauche	Droit	
Référence colonnes cannelées	5061 G	5061 D	5062 G	5062 D	5063 G	5063 D	-	-	
Référence colonnes lisses	5071 G	5071 D	5072 G	5072 D	5073 G	5073 D	-	-	

\* Sur devis possibilité d'adapter le meuble pour des hauteurs jusqu'à 300 cm (fabrication spéciale sur devis).

Possibilité d'augmenter le nombre de niches du meuble (niche standard 57 x 44 cm). Les étagères en verre et les spots sont fournis avec les meubles, (sauf pour les niches d'angle). Étagères en verre : une par niche partie basse, trois par niche partie haute. Spots : un par niche.

Meuble bibliothèque



## LES MEUBLES DE SALLE DE BAINS

STAFF DÉCOR propose un concept de décor de salle de bain composé d'arcades et de meuble en résistaff réalisés sur mesure. Devis et réalisation sur plan.

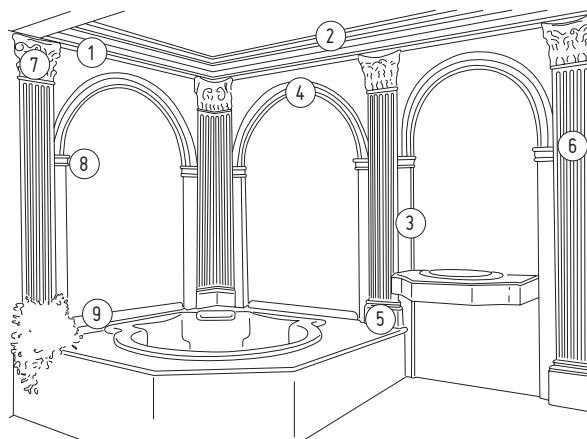

- |                       |                                 |
|-----------------------|---------------------------------|
| 1 - Cornière 17 x 5   | 6 - Pilastre 23 cm, réf. 1050   |
| 2 - Corniche          | 7 - Tête de pilastre, réf. 1055 |
| 3 - U largeur 45 cm   | 8 - Moulure, réf. 1343          |
| 4 - Arcade sur-mesure | 9 - Moulure, réf. 1366          |
| 5 - Socle réf. 1005   |                                 |



Dimensions :  
longueur 210 cm,  
profondeur : 65 cm.

Meuble de salle de bain. Différentes autres configurations sont possibles :

- Meuble avec 2 portes
- Meuble avec 2 portes et tiroirs ...

Le plateau peut être réalisé en Résistaff, marbre, verre, Corian (sur devis)



*Composez-vous même l'ambiance de votre salle de bain  
à l'aide de nos produits !*



PILASTRE 1025  
PAGE 114

CORNICHE D530  
PAGE 36



VOÛTE  
PAGE 141

# PASSAGES & MEUBLES DE PASSAGE

CÔTÉ DE PASSAGE TYPE 2618  
PAGE 142



# LES PASSAGES CLASSIQUES

Droit (1), en arc de cercle (2) ou en anse de panier (3), les habillages de passage, traits d'union de votre décoration, redessinent l'espace et s'intègrent harmonieusement dans tous les styles.

Le staff offre en plus, une grande variété de finitions.

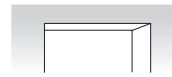

Type 1



Type 2 (ADC)



Type 3 (ADP)

Largeur cm	DESSOUS DE POUTRE (passage type 1)				CÔTÉ DE PASSAGE(*)	
	Avec rond central		Avec rectangle central		Longueur 2.60 ml	Épaisseur 25 mm
	Longueur 2.50 ml	Épaisseur 25 mm	Longueur 2.50 ml	Épaisseur 25 mm		
19	22104		22116		2019	
24	22105		22117		2024	
32	22106		22118		2032	
39	22107		22119		2039	
44	22108		22120		2044	
50	22109		22121		2050	
60	22110		22122		2060	
Sur mesure	Fabrication sur devis nous consulter				(*) Les côtés de passages peuvent également dans certains cas, être remplacés par des pilastres cannelés	

La longueur du dessous de poutre et des côtés de passage est ajustée en fonction des dimensions du passage existant, lors de la pose de ces éléments.



*Avec rond ou rectangle central.*

Habillage de passage type 1

- dessous de poutre réf. 22107
- côtés réf. 2039
- moulure réf. 1345

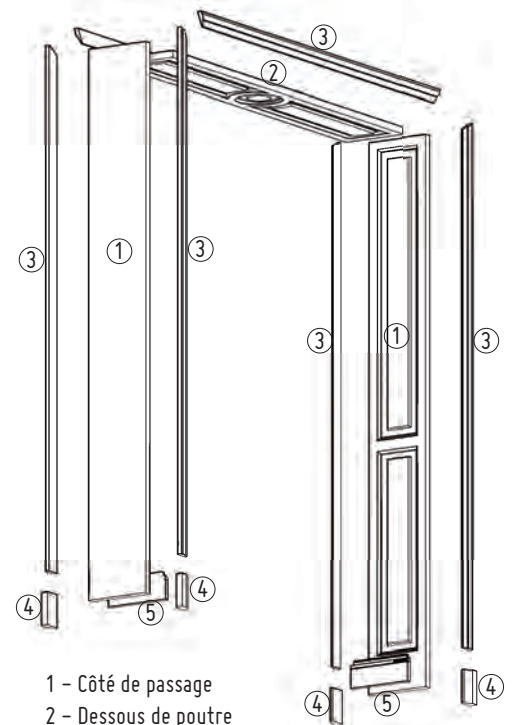

- 1 - Côté de passage
- 2 - Dessous de poutre
- 3 - Moulure
- 4 - Talon
- 5 - Plinthe



VOÛTE AVEC RECTANGLE CENTRAL

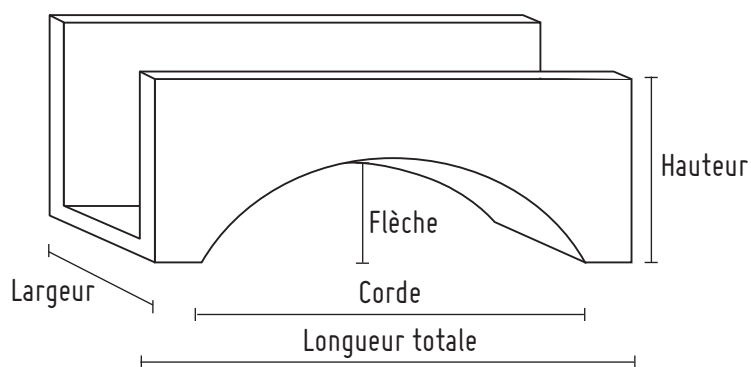

Fabrication en anse de panier ou en arc de cercle sur devis en fonction des dimensions de la voûte souhaitée : largeur, longueur, corde, flèche et hauteur.

Plinthe de 10 cm  
 PLIP1012 pour passage de 12 cm  
 PLIP1017 pour passage de 17 cm  
 PLIP1019 pour passage de 19 cm  
 PLIP1024 pour passage de 24 cm  
 PLIP1032 pour passage de 32 cm

Plinthe de 12 cm  
 PLIP1212 pour passage de 12 cm  
 PLIP1217 pour passage de 17 cm  
 PLIP1219 pour passage de 19 cm  
 PLIP1224 pour passage de 24 cm  
 PLIP1232 pour passage de 32 cm

- 1 - Côté de passage
- 2 - Voûte
- 3 - Moulure cintrée
- 4 - Moulure
- 5 - Talon
- 6 - Plinthe

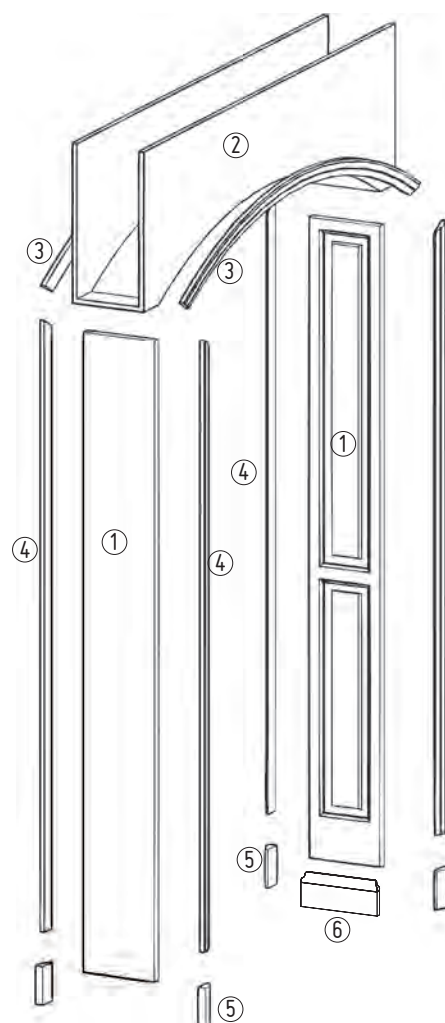



# LES PASSAGES CONTEMPORAINS

Des habillages de passage qui apporteront une touche contemporaine à votre décor.

Différents modèles peuvent être utilisés pour le même passage. Par exemple, deux éléments avec le motif «Anneaux» (Réf.2618) pour les côtés du passage et un élément lisse (Réf. 2718) pour le dessous de poutre.

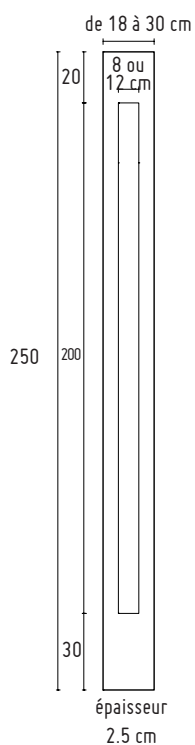

Sur mesure possible.

## Décaissé lisse



2718  
Largeur 18 cm  
(décaissé central 8 cm)

2724  
Largeur 24 cm  
(décaissé central 12 cm)

2730  
Largeur 30 cm  
(décaissé central 12 cm)

## Décaissé motif anneaux



2618  
Largeur 18 cm  
(décaissé central 8 cm)

2624  
Largeur 24 cm  
(décaissé central 12 cm)

2630  
Largeur 30 cm  
(décaissé central 12 cm)

## Décaissé motif CL10



2518  
Largeur 18 cm  
(décaissé central 8 cm)

2524  
Largeur 24 cm  
(décaissé central 12 cm)

2530  
Largeur 30 cm  
(décaissé central 12 cm)

# LES PASSAGES ÉCLAIRANTS

Habillage de passage conçu pour recevoir un ruban LED. L'éclairage met en valeur le motif (CL10, page 92) en soulignant son relief. Ce profil lumineux peut aussi être encastré dans votre mur ou plafond (Réf. 2800L).

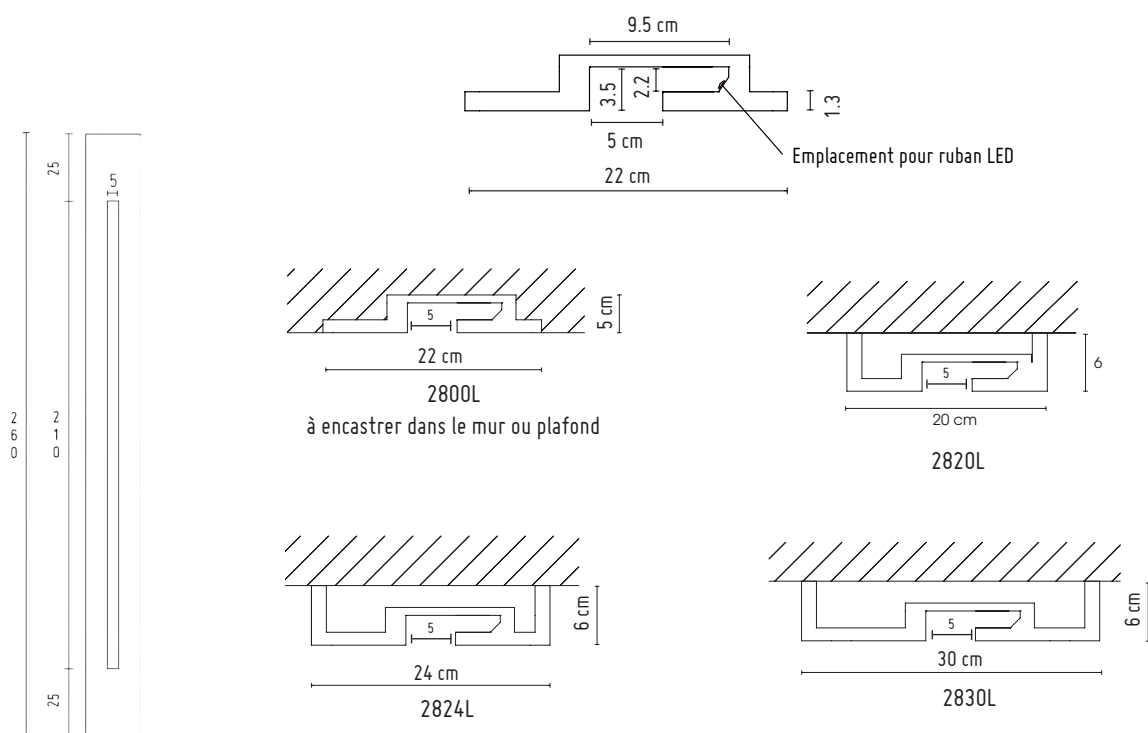

Autres dimensions possibles, nous consulter pour plus d'informations.



PASSAGE ÉCLAIRANT

# LES MEUBLES DE PASSAGE

*Envie de démarquer vos espaces de façon originale ?*

Meuble passage de style contemporain, prêt à poser, livré en deux éléments :

- une partie basse pré-assemblée
- une colonne lisse, diamètre 20 cm



Laissez-vous guider & inspirez vous de nos compositions !

Élément complet avec étagères en verre et passage

*OU*

Élément de base avec sa colonne

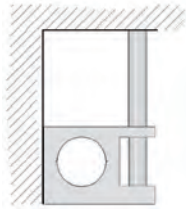
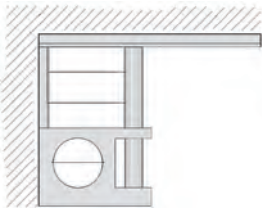

Visuel non contractuel.

22140	Ensemble meuble + colonne - Meuble assemblé avec colonne partie basse - Colonne partie haute : diamètre 20 cm - hauteur 200 cm (135 cm avec étagères + poutre)	
VER56	Etagère verre basse : 56 cm x 35 cm - ép. 8 mm	
U3225	Poutre 25 cm + 32 cm + 25 cm - en 200 cm	
OPT140	Dessous de poutre avec demi rond : diamètre 4cm - long 200 cm	
OPT141	Pilastre galbé avec réservation étagère 32 x 135 cm	
VER90	Etagère supérieure : 94 cm x 32 cm - ép.8 mm	
SPOT	Spot GU 10 blanc 230 V avec ampoule GU10 Fluocompacte	

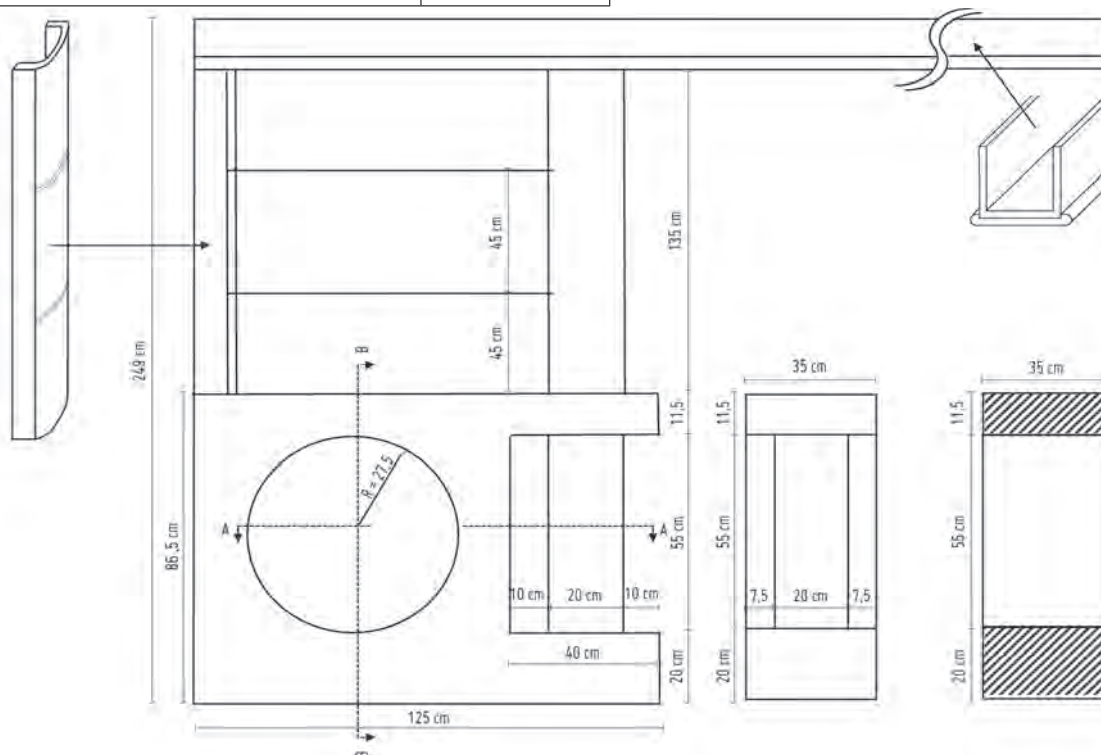

# MEUBLES DE PASSAGE À ESPRIT ⊕ CLASSIQUE

PASSAGE AVEC MEUBLE DE SÉPARATION			
Cet ensemble référencé 22130M comprend les éléments suivants :			
N°	Désignation	Dimensions	Options
1	Voûte	Corde : 102 cm	- Sous face lisse
		Flèche : 30 cm	- Sous face décaissée
		Hauteur 50 cm	Moulure en forme (1125)
			Moulure en forme (1101)
2	Colonne conique avec encoches	Hauteur : 110 cm	- Lisse
			- Cannelée
3	Meuble bas 2 portes	Hauteur : 84 cm	Recto verso
		Largeur : 48 cm	Dos décaissé
		Longueur : 136 cm	/
4	□ dessous lisse	50 x 32 x 50 cm	/
5	Pilastre lisse avec encoches	Hauteur : 110 cm	/
		Largeur : 32 cm	
6	□ côté de passage	(L) longueur ajustable sur demande jusqu'à 250 cm	/
7	Côté de passage en décaissé	Hauteur : 194 cm	/
		Largeur : 32 cm	

Pour toutes commandes, précisez les options choisies et la dimension de (L).

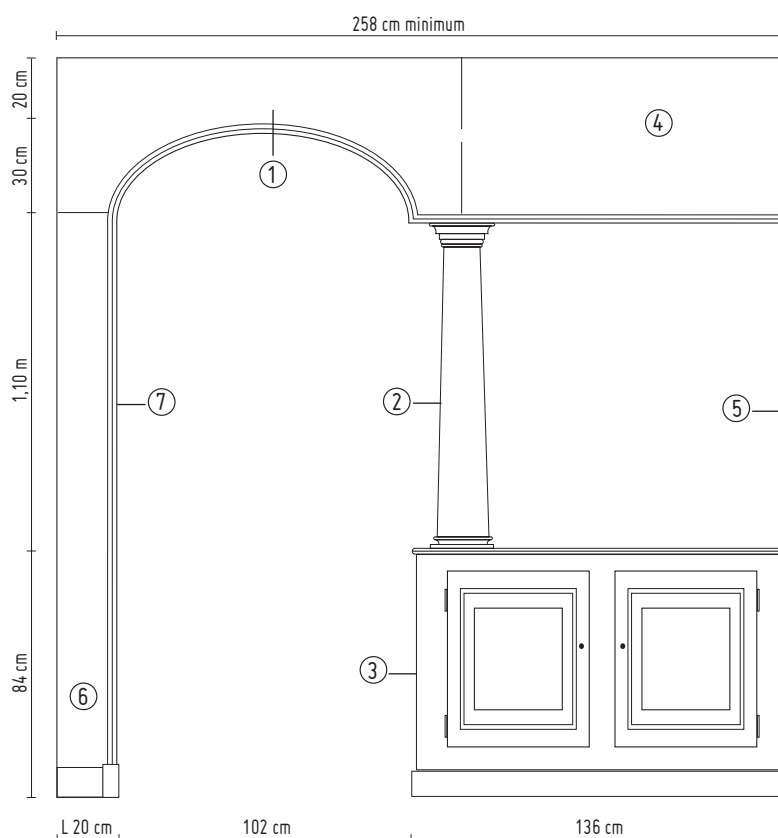



CACHE-RADIATEURS «RONS ALLÉATOIRES»  
PAGE 148

# LES CACHE- RADIATEURS

CACHE-RADIATEUR SUR-MESURE  
DÉCOR CLASSIQUE  
PAGE 149



## LES CONTEMPORAINS

Modèle « Constellation»  
Design du motif par Sophie Briand

Avec sa forme épurée et ses motifs légers, le cache-radiateur «Constellation» s'intégrera avec discrétion et élégance dans votre intérieur. Dimensions sur mesure suivant le schéma ci-contre, motif toujours centré de mêmes dimensions. Possibilité d'installer un éclairage (ruban LED) derrière la façade.

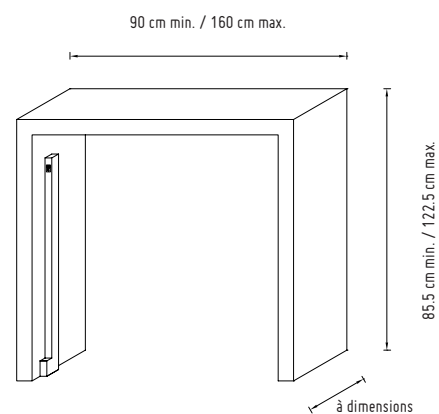
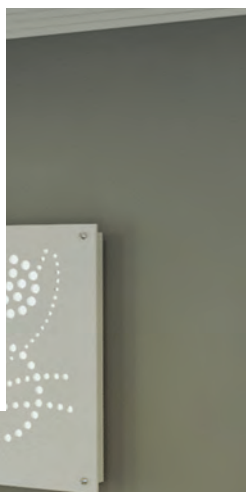

Modèle « Ronds aléatoires»

Fabrication sur mesure, préciser l'encombrement complet de votre radiateur, votre système de réglage compris. Possibilité d'installer un éclairage indirect (ruban LED) derrière la façade.

## LES CLASSIQUES

Pour donner une touche déco à vos radiateurs, sans remettre en cause leur utilité, grâce à des ouvertures prévues pour la circulation de l'air chaud.

La façade amovible permet en outre l'accès au système de réglage du radiateur.

Fabrication sur mesure, préciser l'encombrement complet de votre radiateur, votre système de réglage compris, ainsi que les références de la moulure et la plinthe souhaitées (pour les cache-radiateurs classiques).

CACHE-RADIATEUR CLASSIQUE









PARURE DE CHEMINÉE  
98506  
PAGE 152

# CHEMINÉES

## LES CLASSIQUES



### *Le saviez-vous?*

Le staff est incombustible.

Quoi de plus naturel que de l'utiliser pour habiller vos foyers et hottes de cheminées ?

### STYLE LOUIS XV

Réf. 98006

Trumeau (Hauteur sur mesure -max. 1,80m-, L 105 cm)

Réf. 98506

Parure de cheminée



Réf. 98510, parure de cheminée Louis XV, grand modèle

Dimensions : Hauteur 118 cm, longueur : 155 cm, profondeur : 40 cm

Dimensions du trou à feu : longueur : 108 cm, hauteur : 96 cm

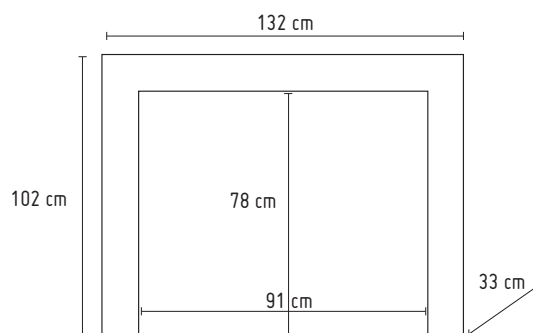

### STYLE LOUIS XVI

Réf. 98000

Trumeau (Hauteur sur mesure -max. 1,80m-, L 103 cm)

Réf. 98500

Parure de cheminée

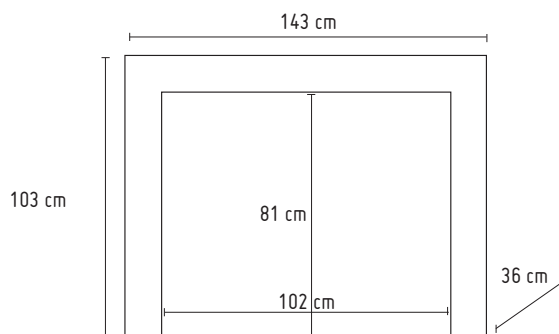

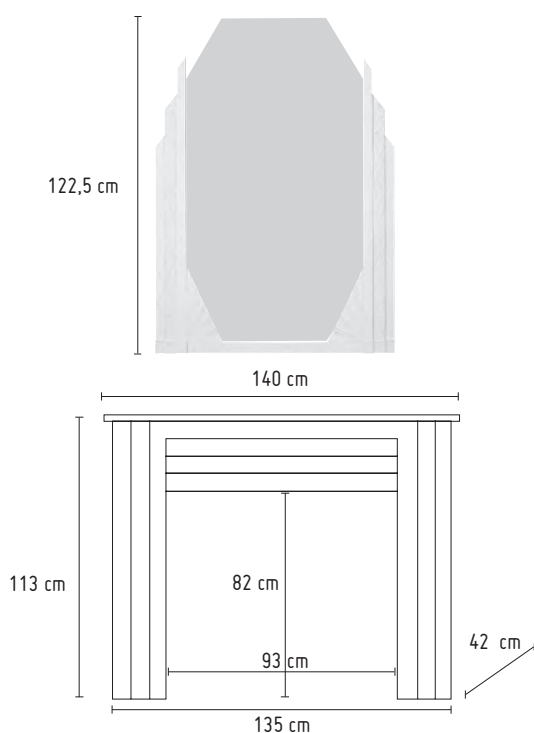

## STYLE ART DÉCO

Réf. 97300  
Miroir Art Déco,  
(H. 122,5 cm, L 84,5 cm)

Réf. 98520  
Parure de cheminée



## LES CONTEMPORAINES

Réf. 98530  
Parure de cheminée

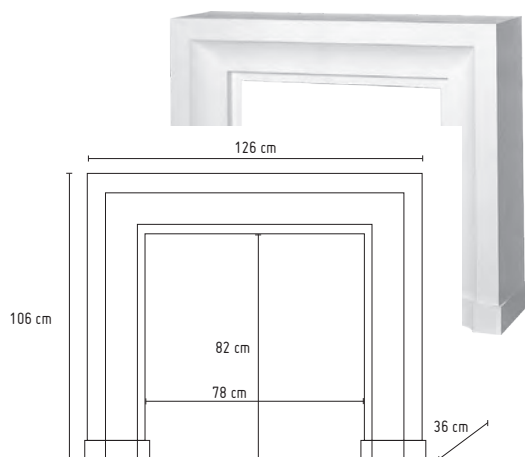

Réf. 98540  
Parure de cheminée

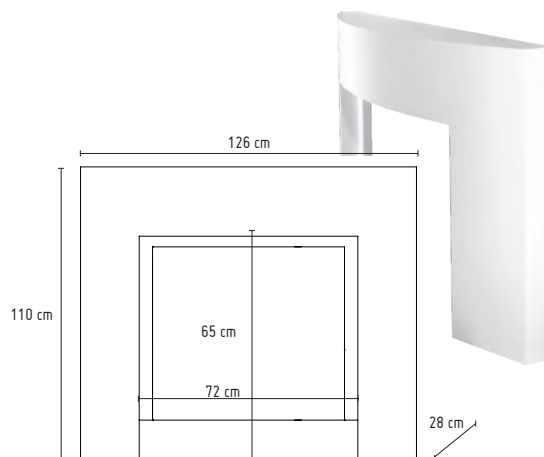



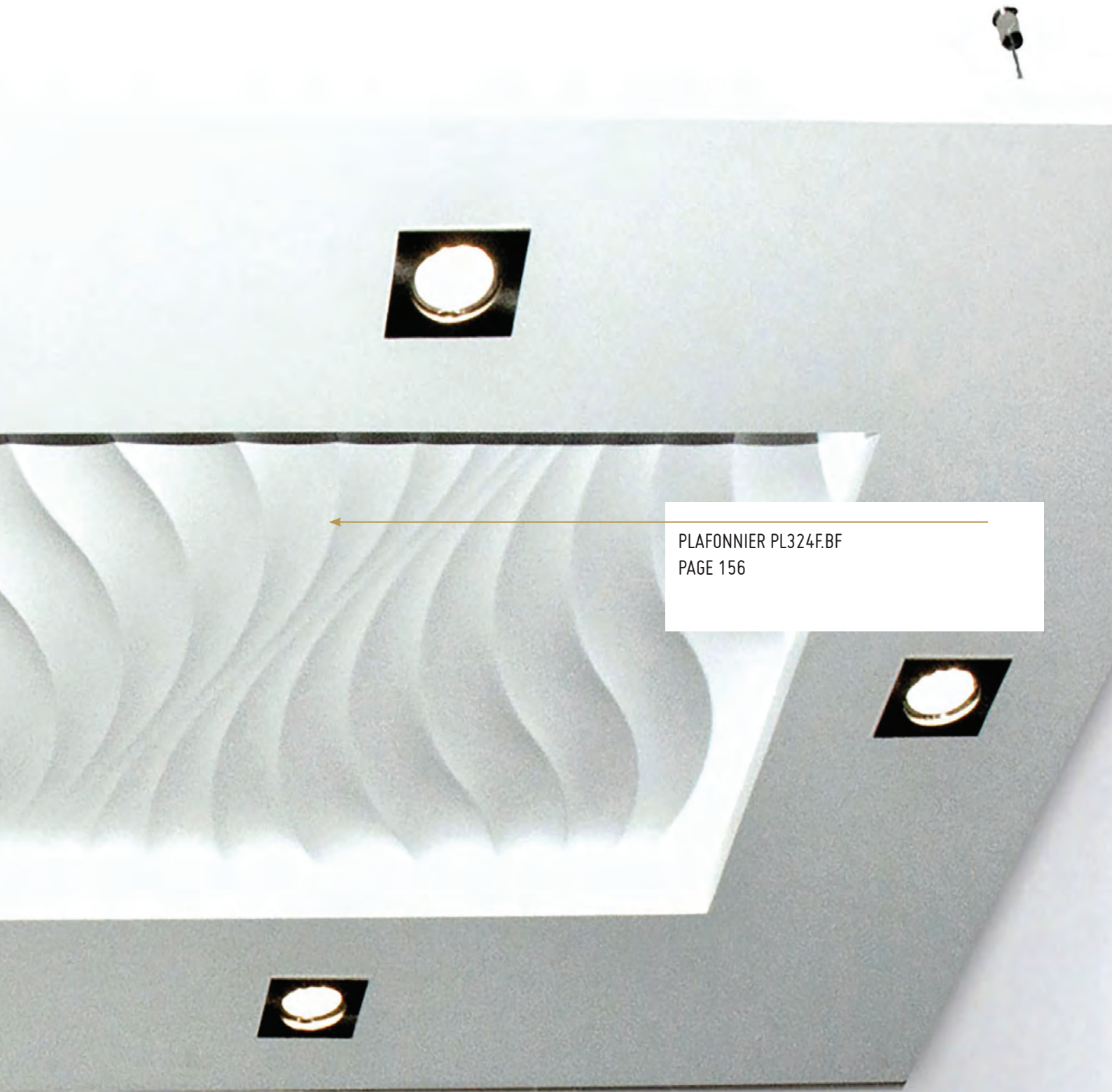

PLAFONNIER PL324F.BF  
PAGE 156

# LUMINAIRES

# LES PLAFONNIERS

PL304 - 314 - 324

Plafonniers rectangulaires

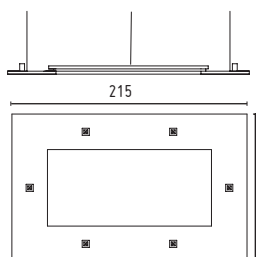

PL304

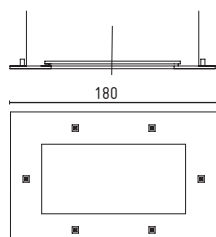

PL314

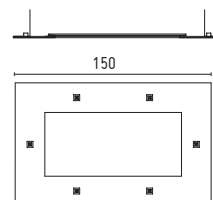

PL324



*Déterminez votre format  
puis choisissez votre modèle  
de plafonnier !*



PLAFONNIER  
PL324F.BF

Rond, carré, rectangulaire...  
Choisissez votre forme,  
piochez un décor.  
Plus d'une centaine  
de combinaisons s'offre à vous !

Équipé de 6 spots carrés LED,  
BC : 6 spots LED 3000 °K • 6 x 600 Lm • IRC 92  
BF : 6 spots LED 4000 °K • 6 x 630 Lm • IRC 92  
Partie centrale rétroéclairée par LED  
B : LED bleu, C : LED blanc chaud 3000 °K,  
F : LED blanc froid 6500 °K.  
Rail Alu et ruban LED extérieur.  
Suspendu par 4 filins métalliques.  
Finition : impression blanche.  
En option : Eclairage dimmable par radio.

BC : Blanc Chaud  
BF : Blanc froid

## PL222 & 223 Plafonniers circulaires

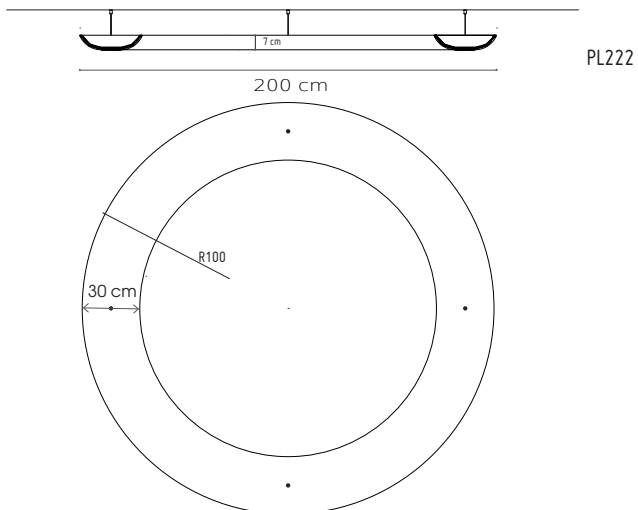

PL222

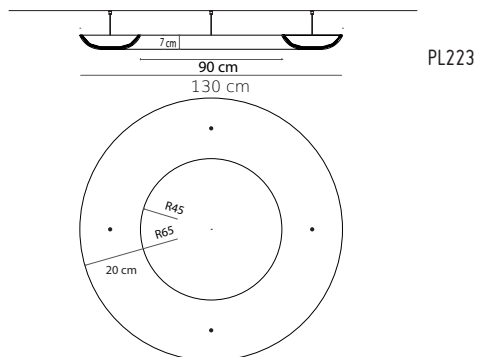

PL223

Partie centrale rétroéclairée par LED

BC : LED blanc chaud 3000 °K,

BF : LED blanc froid 6500 °K.

Suspendu par 4 filins métalliques.

Finition : impression blanche.



Retrouvez tous nos plafonniers  
en flashant notre QR CODE !





PL621

Plafonniers suréquipés

80 x 60 x 5,4 cm

Poids : 8,5 kg

Entraxe de perçage :

40 x 30 cm

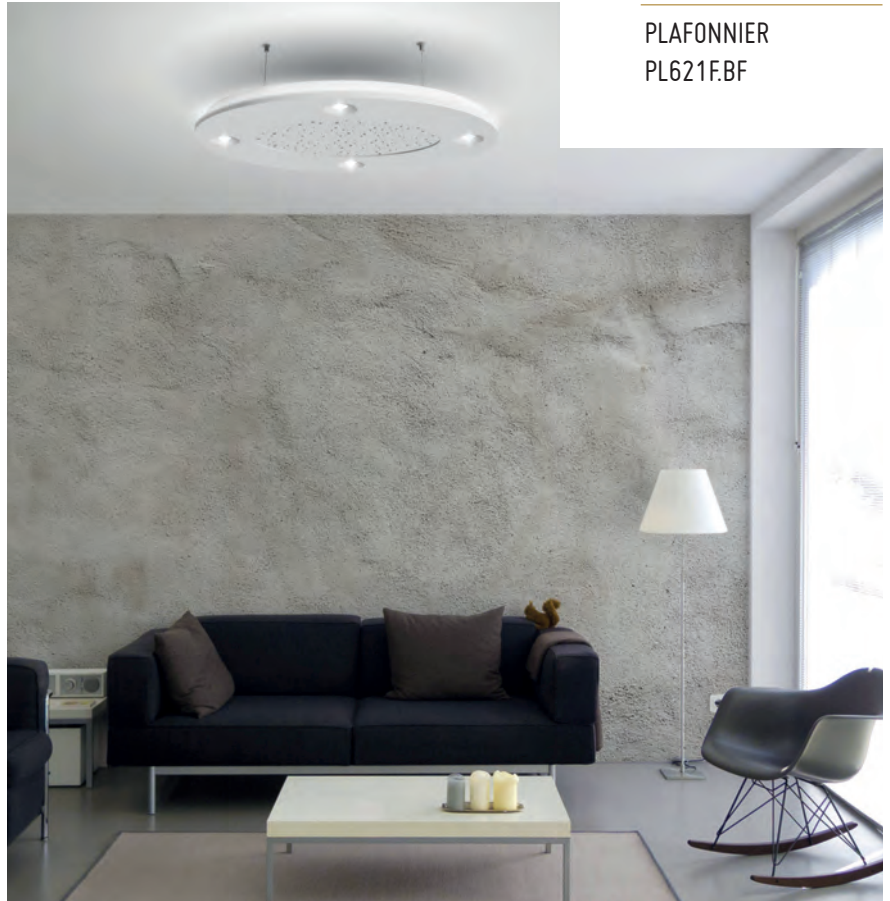

PLAFONNIER  
PL621F.BF



Téléchargez notre catalogue luminaires sur  
[www.staffdecor.fr](http://www.staffdecor.fr) rubrique «Téléchargements»  
en bas de notre site ou demandez le  
auprès de votre conseiller Staff Décor !



*+ de 500 références  
disponibles !*

# LES APPLIQUES

## APPLIQUES



### APPLIQUES

64

L. 26,5 cm x P. 11 cm x H. 55 cm.

Équipement compatible : 57



09

L53 x P26.5 x H25 cm

Équipement compatible : 50BC, 50BF, 52, 56

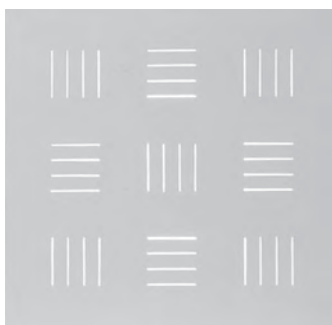

80

L36 cm x P8 cm x H36 cm

Équipement compatible : LED



100

L40 cm x P8 cm x H12 cm

Équipement compatible : 50BC, 50BF

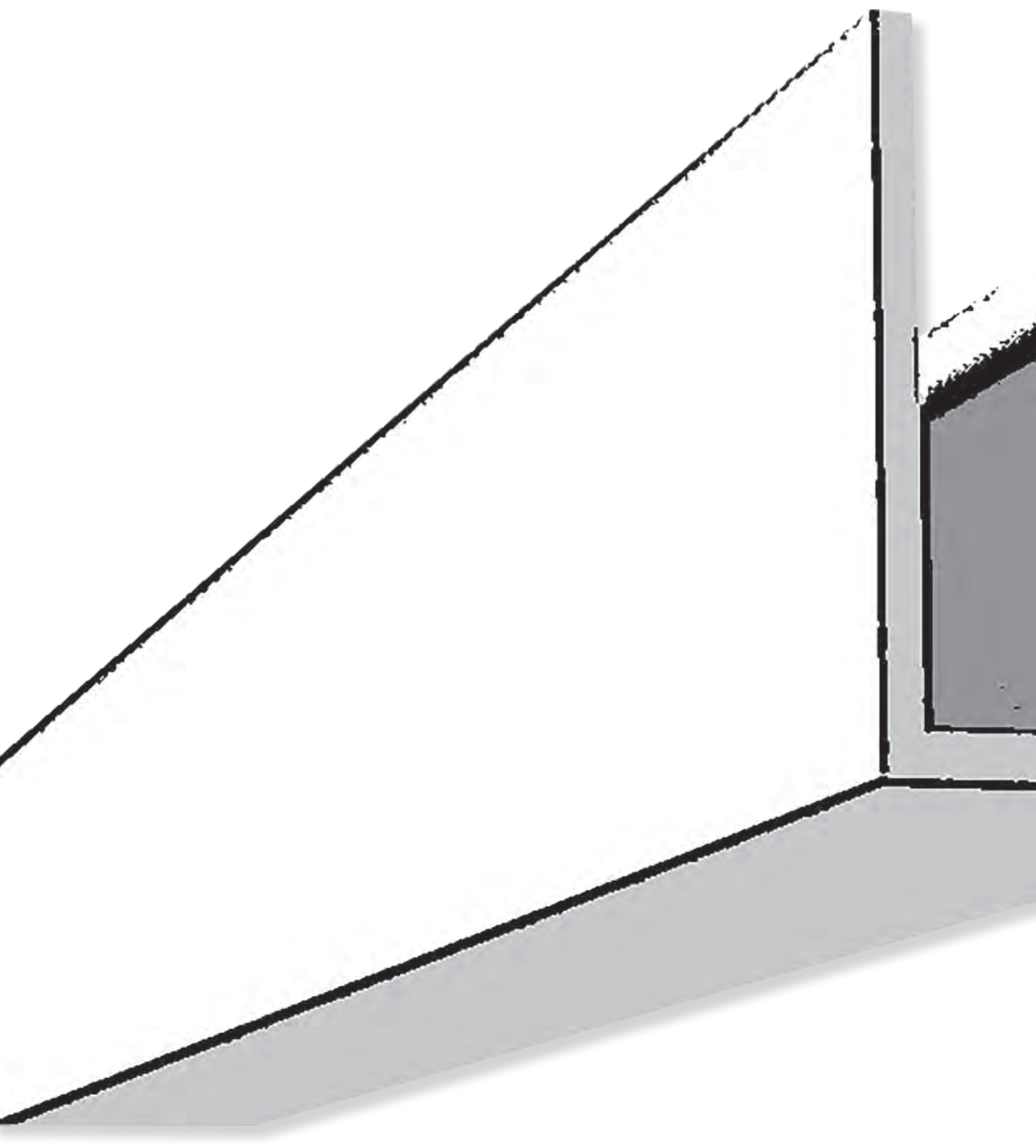



PROFIL U1925  
PAGE 162

# LES PRODUITS TECHNIQUES

## PROFILS EN U



Nos profils en "U" sont livrés en longueur de 2 ml.

Possibilités de fabrication sur-mesure dans d'autres dimensions : délais de fabrication, nous consulter

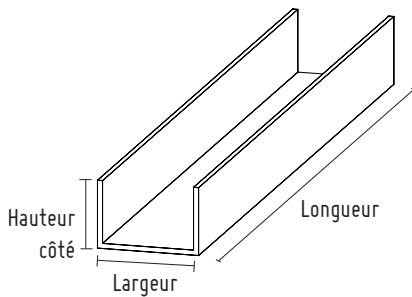

FINITION «PRÊT À PEINDRE» LISSE EXTÉRIEURE en 2 ml		
Réf.	Largeur	Hauteur
U1910	19 cm	10 cm
U1925	19 cm	25 cm
U2410	24 cm	10 cm
U2425	24 cm	25 cm
U3210	32 cm	10 cm
U3225	32 cm	25 cm

## ÉQUERRES



Toutes nos équerrres standardisées sont livrées en longueur de 2 ml.

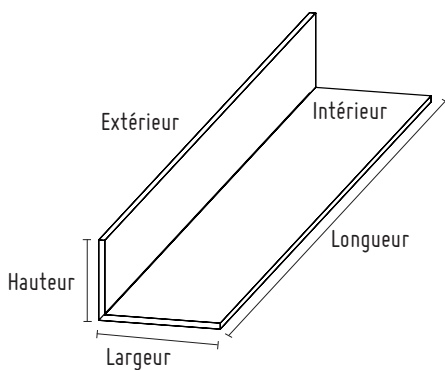

FINITION «PRÊT À PEINDRE» LISSE EXTÉRIEURE en 2 ml		
Réf.	Largeur	Hauteur
E0510E	5 cm	10 cm
E0520E	5 cm	20 cm
E0530E	5 cm	30 cm
E0535E	5 cm	35 cm
E1010E	10 cm	10 cm
E1020E	10 cm	20 cm
E1030E	10 cm	30 cm
E1040E	10 cm	40 cm
E1515E	15 cm	15 cm
E1520E	15 cm	20 cm
E2020E	20 cm	20 cm
E2030E	20 cm	30 cm

FINITION «PRÊT À PEINDRE» LISSE INTÉRIEURE en 2 ml		
Réf.	Largeur	Hauteur
E1020I	10 cm	20 cm
E1520I	15 cm	20 cm
E2020I	20 cm	20 cm
E2030I	20 cm	30 cm

FINITION «PRÊT À PEINDRE» ÉQUERRES BORD PROPRE en 2 ml		
Réf.	Largeur	Hauteur
EBP0530	30 cm	5 cm
EBP0830	30 cm	8 cm
EBP1030	30 cm	10 cm
EBP0525P	25 cm	5 cm

## BANDEAUX BORDS PROPRES

BANDEAUX BORDS PROPRES DE 2ML		
Réf.	Largeur	Épaisseur
BP20	20 cm	1,8 cm
BP30	30 cm	1,8 cm
BP30P	30 cm	1,9 cm

## PLAQUES EN STAFF TRADITIONNELLES



Nous vous proposons la plaque de staff à l'unité ou sur palette de 30, 36 ou 50 unités, dans les dimensions et épaisseurs suivantes :



- PLAQ : 151 x 66 cm en épaisseur de 1,5 cm
- PLAQ2 : 120 x 80 cm en épaisseur de 1,5 cm
- PLAQ3 : 120 x 80 cm en épaisseur de 2 cm
- PLAQ5 ; 151 x 66 cm en épaisseur de 8 mm
- PLAQ6 : 120 x 80 cm en épaisseur de 8 mm

## HABILLAGE DES NEZ DE CLOISONS

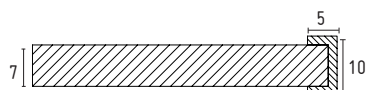

FINITION LISSE EXTÉRIEURE POUR NEZ DE CLOISON EN 2,50 ML		
Réf.	Largeur	Hauteur
UF1005	10 cm	5 cm

## LE SYSTÈME DE CLOISONS & DE PLAFONDS



Accrochage mécanique sur ossature métallique. Finition des joints au plâtre pour le scellement.  
Demandez à votre conseiller Staff Décor nos fiches techniques et conseils de pose !



Plaque de cloison



Plaque de plafond

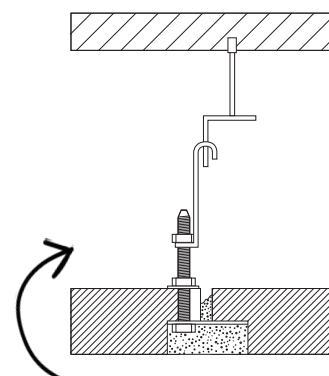

Vue en coupe du système de plafond (système breveté).

## LES ENDUITS & MATÉRIEL DE POSE



La colle-enduit STAFF DÉCOR : Facile à travailler, elle reste blanche après séchage et peut être utilisée pour le collage, le rebouchage et la finition. Son utilisation est conseillée pour l'ensemble des produits de notre gamme.

- 0029 en sac de 5 Kg.
- 0010 en seau de 10 kg.
- 0028 en sac de 25 Kg.



Boîte à coupe adaptée à la dimension des corniches, que vous aurez réglée en fonction de leur encombrement sur le mur et le plafond (côtes de pose conseillées indiquées en face de chaque référence) :

- Boîte à coupe en 1 ml : 0005.
- Boîte à coupe en 2 ml : 0006.
- Boîte à coupe grand modèle en 2 ml : 0007.



Etais de pose télescopiques : 0018

Ces étais servent à soutenir l'élément collé pendant le temps de prise de l'enduit.

# INDEX

Référence produit	Page	Référence produit	Page	Référence produit	Page
0005	163	1000	100-114	1141C	103
0006	163	1001	114	1145C	103
0007	163	1002	114	1150	42 - 46
0010	92 - 163	1003	100-114	1150BH	46
0018	163	1004	114	1151	42 - 46
0028	163	1005	114 - 136	1151BH	46
0029	163	1025	114 - 137	1153	46
0034	104	1050	114 - 136	1155	40
0036	104	1055	114 - 136	1156	40 - 105
09	159	1101	41-40-47-145	1157	42
0710	129	1101BH	47	1165	106
0712	129	1101C	70 - 103	1166	40
0714	128	1101D	47	1200	40 - 46
0724	128	1101F	47	1200BH	46
0726	128	1101G	47	1201	40
0732	129	1101H	47	1202	40 - 47
0734	128	1101P	47	1202B	47
0742	129	1102	40 - 43 - 47	1202BH	47
0744	128	1102BH	47	1202H	47
0760	116	1103	40 - 46	1203	43 - 47
0761	116	1103BH	46	1204	12 - 42 - 47
0762	116	1103C	103	1204BH	47
0765	116	1103D	44 - 46	1204H	13 - 45 - 47
0780	116	1103H	46	1205	42
0781	116	1104	42 - 46	1206	40 - 46
0782	116	1104B	46	1206R	46
0785	116	1104H	46	1206S	46
0800	71 - 116	1105	42 - 46	1207	40 - 47
0801	116	1105B	46	1207BH	47
0802	116	1105H	46	1208	42 - 47
0803	116	1106	42	1208D	47
0804	116	1107	40 - 47	1209	40
0805	116	1107BH	47	1210	40 - 46
0806	116	1107P	47	1210BH	46
0900	117	1108	40 - 105 - 106	1220	40
0901	117	1109	42	1221	40
0902	117	1110	42	1250D	68
0903	117	1111	42	1250G	67 - 68
0904	117	1112	42	1251	68
0905	117	1113	42	1252	68
0950	115	1114D	42	1253	68
0951	115	1114G	42	1254	68
0952	115	1120	40 - 106	1268	10
0955	115	1121	40 - 106	1271	68
0999	114	1124	40 - 106	1275	68
100	159	1125	40 - 106 - 145	1301	38 - 42
		1130	40 - 106	1302	38 - 42
		1140C	102	1303	13- 38 - 42
				1304	38 - 42
				1305	42
				1306	42
				1310	42
				1320	43
				1321	42

Référence produit	Page	Référence produit	Page	Référence produit	Page
1322	42	1420M	47	2624	142
1323	42	1420T	47	2630	142
1324	40	20.01	109	2718	142
1325	42	20.02	108 - 111	2724	142
1326	42	20.03	109	2730	142
1327	42	20.04	108	2800L	143
1328	42	20.05	108	2820L	143
1329	42	20.06	110 - 112	2824L	143
1330	42	20.06B	110 - 112	2830L	143
1331	42	20.06H	112	22104	140
1332	42	20.06S	110 - 112	22105	140
1333	42	20.08	110 - 112	22106	140
1334	43	20.51	109	22107	140
1335	43	20.52	108	22108	140
1340	42	20.53	109	22109	140
1341	43	20.54	108	22110	140
1342	43	20.55	108	22116	140
1343	40 - 136	20.56	110 - 112	22117	140
1344	40	20.56B	110 - 112	22118	140
1345	39-40-41-140	20.56H	112	22119	140
1346	43	20.56S	110 - 112	22120	140
1347	43	20.57	112	22121	140
1348	43	20.57BD	112	22122	140
1349	43	20.57BG	112	22130M	145
1364	40 - 106	20.57HD	112	22140	144
1365	40	20.57HG	112	22150	132
1366	40 - 106 - 136	20.57SD	112	22160.445	132
1367	40 - 106	20.57SG	112	22160.545	132
1371	43	20.58	110-112	22160.605	132
1372	43	20.59	112	22160.675	132
1373	43	201	68	30.02	110
1374	42 - 93	2000	100-113	30.03	110
1380	40	2001	113	30.04	110
1400	50	2004	100-113	30.05	110
1401	50	2005	113	30.06	110
1402	50	2019	140	30.07	110
1403	50	2020	113	30.08	110
1404	50	2024	70 - 140	30.09	110
1405	50	2030	115	30.10	110
1406	50	2030M	115	30.11	110
1407	50	2031	114 - 115	30.12	110
1408	50	2031C	115	30.52	110
1409	12 - 47	2031M	115	30.53	110
1410	47	2032	140	30.54	110
1411D	47	2039	140	30.55	110
1411G	47	2044	140	30.56	110
1412	50	2050	140	30.57	110
1413	50	2060	140	30.58	110
1414	50	2518	142	30.59	110
1415	50	2524	142	30.60	110
1416	50	2530	142	30.61	110
1420H	47	2618	142	30.62	110



Référence produit	Page	Référence produit	Page	Référence produit	Page
30.63	110	41.51	110	5032G	133
31.01	110	41.52	110	5033D	133
31.02	110	41.53	110	5033G	133
31.03	110	41.55	110	5034D	133
31.04	110	45.01	110	5034G	133
31.51	110	45.02	110	5041	134
31.52	110	45.03	110	5042	134
31.53	110	45.04	110	5043	134
31.54	110	45.05	110	5044	134
32.51	69	45.06	110	5051	134
3000	115	45.07	110	5052	134
3800	47	45.51	110	5053	134
3900	71 - 106	45.51C	69	5054	134
3901	107	45.52	110	5061D	134
3902	106	45.53	110	5061G	134
3903	107	45.54	110	5062D	134
3904	107	45.55	110	5062G	134
3905	106	45.56	110	5063D	134
3906	114	45.57	110	5063G	134
30051	134	4200	47	5071D	134
30052	134	4201	47	5071G	134
30053	134	50.050	65	5072D	134
30054	134	50.ATLA	65	5072G	134
30059	134	50.LET1	84	5073D	134
30061	133	50.LET2	84	5073G	134
30062	133	50.LET3	84	64	159
30063	133	50.NIAG	48 - 64 - 65	6200	129
30069	133	50.SIER	65	7001	117
40.01	108 - 109 - 111	50BC	159	7002	117
40.02	109	50BF	159	7003	117
40.03	108	52	159	7004	117
40.04	108 - 110	56	159	7005	117
40.05	109 - 110	57	159	7006	117
40.06	108 - 110	5001	133	7035	88
40.07	108	5002	133	7036	89
40.07A	108	5003	133	7036PLIN	89
40.08	108	5004	133	7036U	89
40.09	108	5011	133	7038	76
40.10	108 - 109	5012	133	7039A	90
40.20	109	5013	133	7039B	90
40.30	108	5014	133	7040	76
40.40	108 - 110	5021D	133	7041	76 - 77
40.50	109 - 110	5021G	133	7048	77
40.60	108 - 110	5022D	133	7049	77
40.61	69	5022G	133	7051	77
40.70	108	5023D	133	7053	77
40.70A	108	5023G	133	7060	76
40.80	108	5024D	133	7061	76
40.90	108	5024G	133	7062	91
41.01	110	5031D	133	7063	75 - 91
41.02	110	5031G	133		
41.03	110	5032D	133		

Référence produit	Page	Référence produit	Page	Référence produit	Page
7063-1	91	942.73	105	9411	101
7063-2	91	942.83	105	9412	101
7063-3	91	943.63	105	9413	101
7063-4	91	943.73	105	9450	100
7070	82	943.83	105	9451	100
7071	82	950.63	105	9460	100
7072	82 - 83 - 119	950.73	105	9461	100
7073	78 - 82	950.83	105	97300	153
7074	82	952.63	105	98000	152
7075	82	952.73	105	98006	152
7078	84	952.83	105	98500	152
80	159	960.00	104	98506	151 - 152
901.63	105	9001	103	98510	152
901.73	105	9002	103	98520	153
901.83	105	9003	103	98530	153
902.63	105	9011	103	98540	153
902.73	105	9012	103	A.OT20/24	131
902.83	105	9013	103	AA-R1707	131
903.63	105	9020	102	B700	66 - 69
903.73	105	9021	102	B701	69
903.83	105	9025	102	B702	69
911.63	105	9031	103	B703	69
911.73	105	9032	103	BL120	26 - 27
911.83	105	9033	103	BL122	27
912.63	105	9201	99	BL130	28
912.73	105	9202	99	BL131	28
912.83	105	9203	99	BL132	28
913.63	105	9204	99	BL140	131
913.73	105	9205	99	BL160	28
913.83	105	9206	99	BL170	29
921.63	105	9211	99 - 102	BL170R25E	29
921.73	105	9212	99	BL170R25I	29
921.83	105	9213	99	BL170R50E	29
922.63	105	9214	99	BL170R50I	29
922.73	105	9215	99	BL180	28
922.83	105	9216	99	BP20	162
930.63	105	9221	99	BP30	162
930.73	105	9222	99	BP30P	162
930.83	105	9223	99	CHEVET1	131
9315.23	101	9224	99	CHEVET2D	131
9315.30	101	9225	99	CHEVET2G	131
9315C	98 - 102	9226	99	CIEL DE LIT	7
932.63	105	9280	101	CL10	92 - 143
932.73	105	9301	98	CL11	92
932.83	105	9302	98	CL12	94
933.63	105	9303	98	CL1374	93 - 95
933.73	105	9304	98	CL31	74
933.83	105	9310	98	CL31A	86
940.63	105	9311	98	CL31B	86
940.73	105	9312	98	CL32	78 - 79 - 87
940.83	105	9401	101	CL33	87
942.63	105	9402	101	CL34	88
		9403	101	CL35	88

Réf. produit	Page	Réf. produit	Page	Réf. produit	Page	Réf. produit	Page
CL36	8-88	D606	32	D802	30	EBL0430	27
CL37	95	D607	32	D810	34	EBP0525P	162
C080	37	D608	31	D812	35	EBP0530	162
C090	37	D609	31	D813	35	EBP0830	162
C0100	37	D610	31	D814	34	EBP1030	162
C0105	37	D611	31	D815	34	EMB95	27
C0110	37	D612	31	D818	36	ENC31	10
C0120	37	D614	31	D820	33	ENC32	10
D101	25	D615	36	D830	31	ENC35	10
D102	25	D616	32	D835	36	ENC41	11
D103	25	D617	34	D840	34	JC22.10	23
D104	25	D620	19	D843	35	JC22.20	23
D105A	25	D621	19	D844	35 - 37	JC22.30	23
D105B	25	D622	32	D845	35	JC22.40	23
D106	26	D623	32	D846	36	JC55.10	23
D107	26	D624	32	D880	32	JC55.20	23
D108	26	D625	31	D880A	32	M038	50
D110	9	D626	31	D880B	6	M039	59
D118	9	D627	36	D884	35	M040	51
D121	9	D628	34	D885	35	M041	51
D505	35 - 37	D629	34	D886	33	M042	51
D510	35 - 37	D630	31	D888	33	M043	51
D513	36	D631	19	D889	34	M044	51
D515	34	D632	11	D890	36	M045	53
D520	31	D633	11	D890A	36	M046	53
D525	36	D650	32 - 33	D891	18	M047	51
D530	36 - 137	D651	32	D892	30	M048	59
D531	34	D652	32	D893	35	M049	50
D535	36	D653	33	D894	35	M050	50
D540	36	D654	32	D895	35	M051	52
D545	31	D655	36	D896	33	M052	55
D550	36	D656	33	D897	35	M053	53
D555	19	D657	33	D898	16 - 34	M054	62
D560	30	D658	11	D899	34	M055	53
D561	19	D702	32	D900	30	M056	52
D562	19	D703	31	D901	19	M057	52
D563	19	D704	31	D902	34	M058	51
D564	18	D705	19	D903	11	M059	52
D565	18 - 19	D706	19	E0510E	162	M060	63
D566	35	D707	31	E0520E	162	M061	52
D567	18	D708	24	E0530E	162	M066	62
D568	18	D709	24	E0535E	162	M067	60
D569	34	D710	24	E1010E	162	M068	59
D570	35	D711	36	E1020E	162	M069	59
D574	31	D712	36	E1020I	162	M070	55
D575	17 - 19 - 119	D713	33	E1030E	162	M071	13 - 59
D576	19	D715	34	E1040E	162	M072	52
D577	18 - 20	D716	36	E1515E	162	M073	52
D578	19	D717	33	E1520E	162	M100	51
D579	18	D718	19	E1520I	162	M101	51
D580	19	D720	19	E2020E	162	M101	51
D601	30 - 37	D748	24	E2020I	162	M102	51
D604	31	D749	24	E2030E	162	M102	53
D605	31	D801	30 - 33	E2030I	162	M201	52

Référence produit	Page	Référence produit	Page	Référence produit	Page
M202	52	MOA23	125	S606	32
M203	59	MOA24	125	S611	32
M204	52	MOAC	125	S616	32
M205	52	MOAPLIN10	125	S702	32
M206	53	MOAPLIN10M	125	S707	32
M207	53	MOAPLINT	125	S908	22
M208	59	MOAS	125	S908A	22
M209	59	MOD05	124 - 127	SD7042	76
M210	59	MOD06	124	SD7043	80
M211	51	MOD23	122 - 124	SD7044	80
M212	62	MOD24	124 -125 -126	SD7045	84
M213	53	MOD25	124	SD7046	85
M250	63	MODC	124	SD7047	76
M251	63	MODS	124	SD7052	80
M252	63	MOE45	124	SD7054	76
M253	63	MOE60	124	SD7055	79 - 84
M254	54	MOE90	124	SD7056	76
M255	61	MOE120	124	SD7057	80
M296	61	OPT140	144	SD7500	79 - 81
M297	54	OPT141	144	SD7501	81
M298	62	pl319	11	SD7502	81
M299	54	PL222	157	SD7503	81
M300	54	PL223	157	SD7504	81
M301	49 - 54	PL304	156	SDC1	103
M302	55	PL314	156	SDC2	103
M303	55	PL324F.BF	155 - 156	SDPA1/A2/A3/A4	24
M304	55	PL621	158	SP0T	144
M306	62	PL621F.BF	158	SV577	21
M390	60	PLAQ	162	SV748	21
M400	58	PLAQ2	162	T.CAPITON165	130
M401	56	PLAQ3	162	T.CAPITON180	130
m401P	10	PLAQ5	162	T.OCEAN160	130
M402	56	PLAQ6	162	T.OCEAN180	130
M403	56	PLIN08	103	T.SAHARA140	131
M404	60	PLIN08M	103	T.SAHARA160	131
M405	57	PLIN10	103	T.SAHARA180	131
M406	61	PLIN10A	103	TAL12	106
M407	61	PLIN10M	103	TAL14	106
M420	69	PLIN12	103	TAL17	106
M421	69	PLIN12A	103	TALGM	106
M422	69	PLIN15	103	TALP	77
M423	10	PLIN15A	103	TALSP	106
M501	63	PLIN20	103	U1910	162
M502	62	PLINT	103	U1925	161 - 162
M502H	62	PLINTA	103	U2410	162
M604	7	R561	37	U2425	162
M605	7	R601	32	U3210	162
M05-242	127	R606	32	U3225	144 - 162
M05-245	127	R611	32	UF1005	163
M05-545	127	R616	32	US0740	23
M05-B115	127	R702	32	US1040	23
M05-ET398	127	R707	32	VARIANCE	9
M05-F0398	127	S562	37	VER56	144
M05-H115	127	S601	32	VER90	144

# 10 showrooms en France pour répondre à vos besoins !

CAEN  
Z.I. EST - Rue de Bellevue  
14650 CARPIQUET  
TÉL. 02 31 26 27 60  
Fax. 02 31 26 27 66  
email : ag14@staffdecor.fr

MANUFACTURE ET SIÈGE SOCIAL  
Z.A. de l'Hermitière, Route de Nantes  
35230 Orgères (Sud de Rennes)  
TÉL. 02 99 42 30 30 - Fax (33) 02 99 42 36 36  
email : info@staffdecor.fr

STRASBOURG  
Z.I. - 22, rue des Tuileries  
67460 SOUFFELWEYERSHEIM  
TÉL. 03 90 20 37 73  
Fax. 03 90 20 39 11  
email : ag67@staffdecor.fr

VANNES  
Z.I. du Prat - 23, rue du Général Baron Fabre  
56000 VANNES  
TÉL. 02 97 54 25 55  
Fax. 02 97 54 00 11  
email : ag56@staffdecor.fr

PARIS  
ZAC du Plateau - 18, rue des Marronniers  
94240 L'HAY-LES-ROSES  
TÉL. 01 48 52 73 23 - Fax. 01 48 52 52 46  
email : ag94@staffdecor.fr

TOURS  
Z.I. N°2 - 18, rue Etienne Cosson  
37170 CHAMBRAY LES TOURS  
TÉL. 02 47 28 59 66  
Fax. 02 47 27 99 84  
email : ag37@staffdecor.fr

BORDEAUX  
170, cours Médoc - Galerie Tatry  
33000 BORDEAUX  
TÉL. 05 56 29 09 65  
Fax. 05 56 29 09 67  
email : ag33@staffdecor.fr

LYON  
9, boulevard Lucien Sampaix  
69190 SAINT-FONS  
TÉL. 04 78 67 17 17  
Fax. 04 78 67 18 18  
email : ag69@staffdecor.fr

MARSEILLE  
240, av. de Coullins - P. d'activité  
13420 GEMENOS  
TÉL. 04 73 22 22 11

NICE  
27, boulevard de Riquier  
06300 NICE  
TÉL. 04 93 89 77 82  
Fax. 04 93 89 77 94  
email : ag67@staffdecor.fr



TRAX-MATTHIES / STAFF DECOR  
Schwarzer Weg 5 | 22309 Hamburg  
Öffnungszeiten: Mo - Fr. 9.00 - 15.00  
Fon. +49 (0) 40 630 70 26  
Mail. info@stuckhandel.de

# stuckhandel.de