

裕文路 Yu-wen Road

裕信路 Yu-sin Road

中山高速公路 freeway #1

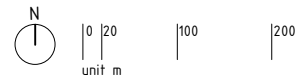

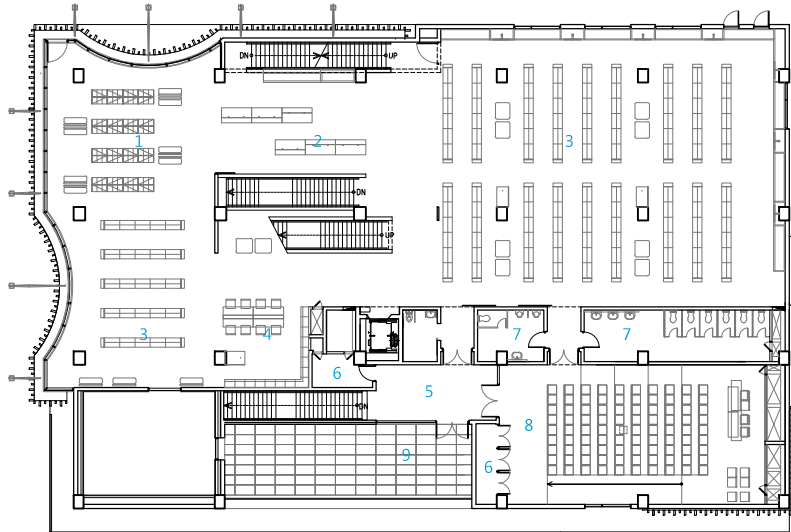

- 1 現期刊區 periodicals
- 2 主題展示區 special display
- 3 書庫及閱讀區 book stacks/ reading area
- 4 參考書區 reference
- 5 室內廊道 foyer
- 6 儲藏室 storage
- 7 廁所 restrooms
- 8 多功能室 Multi-purpose room
- 9 屋頂花園 roof garden

2F plan

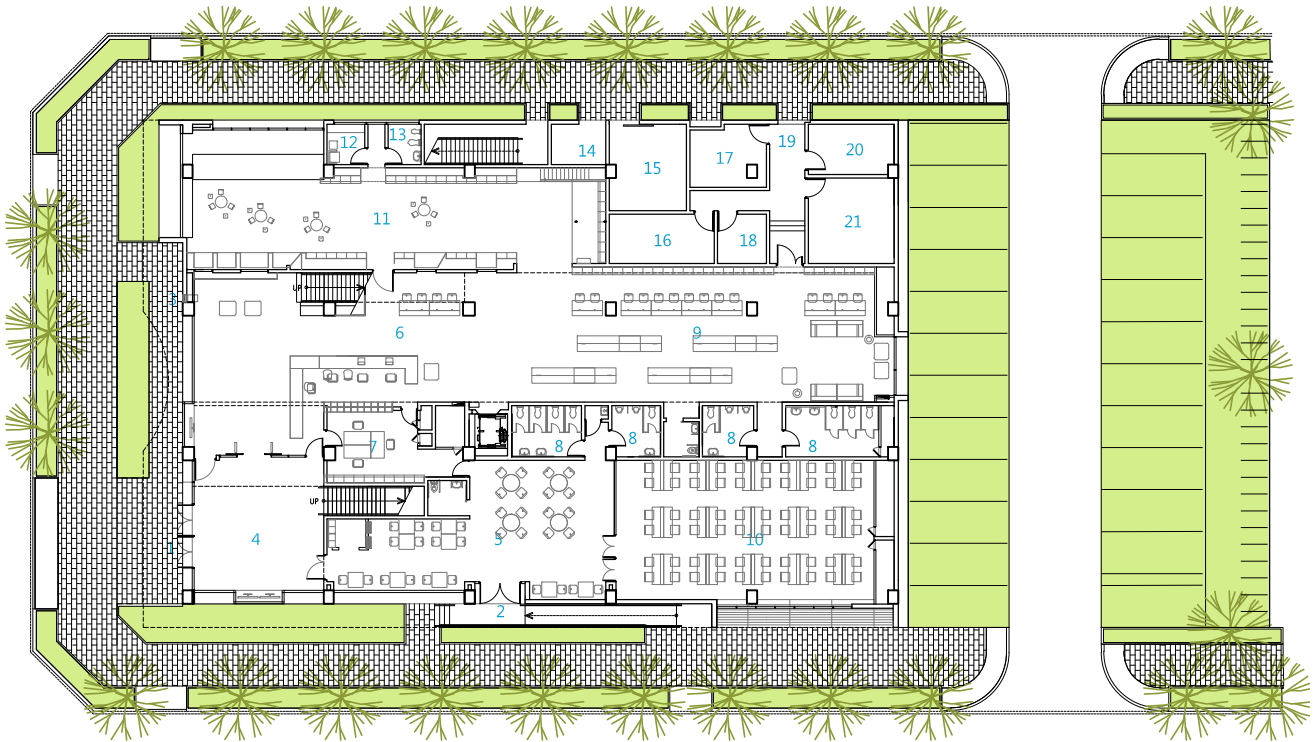

- 1 主入口 main entrance
- 2 次入口 side entrance
- 3 還書箱 book return
- 4 入口大廳 (上部挑空) entrance lobby
- 5 社區書房 (閱報區) community reading room
- 6 流通櫃台及新書區 circulation counter
- 7 工作及志工休息區 office
- 8 廁所 restroom
- 9 學齡兒童及青少年圖書館 young-adult library
- 10 自修室 reading area
- 11 學齡前兒童圖書館 children's library
- 12 育嬰室 nursing room
- 13 親子廁所 parent-child restroom
- 14 垃圾分類儲存空間 recycling storage
- 15 台電配電室 electricity distribution facilities
- 16 消防機械室 firefighting pump room
- 17 變電室 transformer room
- 18 電信室 telecommunication facilities
- 19 維修入口 service entrance
- 20 發電機室 generator room
- 21 機房 mechanical facilities

1F plan

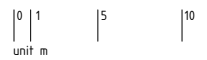

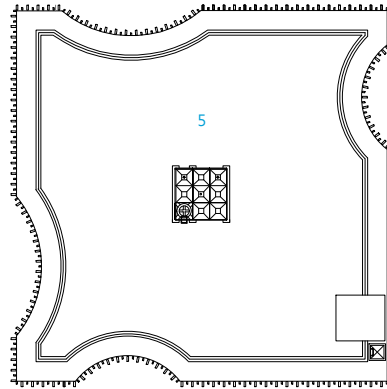
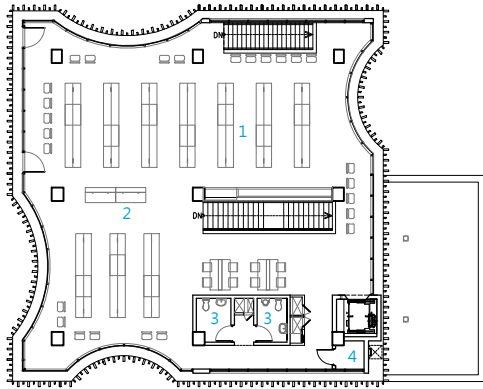

- 1 書庫及閱讀區 low stacks/ reading area
- 2 主題展示區 special display
- 3 廁所 restrooms
- 4 儲藏室 storage
- 5 屋頂層 roof level

4F plan

RF plan

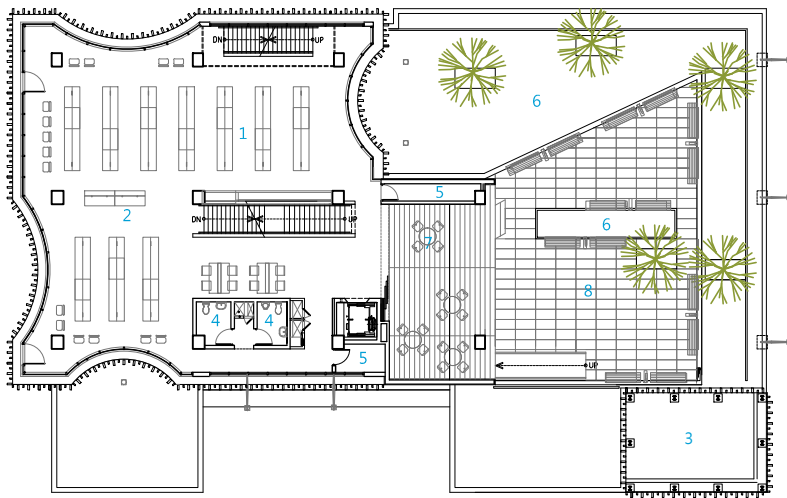

- 1 書庫及閱讀區 low stacks/ reading area
- 2 主題展示區 special display
- 3 空調主機 AC
- 4 廁所 restrooms
- 5 儲藏室 storage
- 6 公共藝術區域 public art area
- 7 半戶外閱讀空間 semi-outdoor reading area
- 8 屋頂花園 roof garden

3F plan

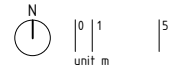

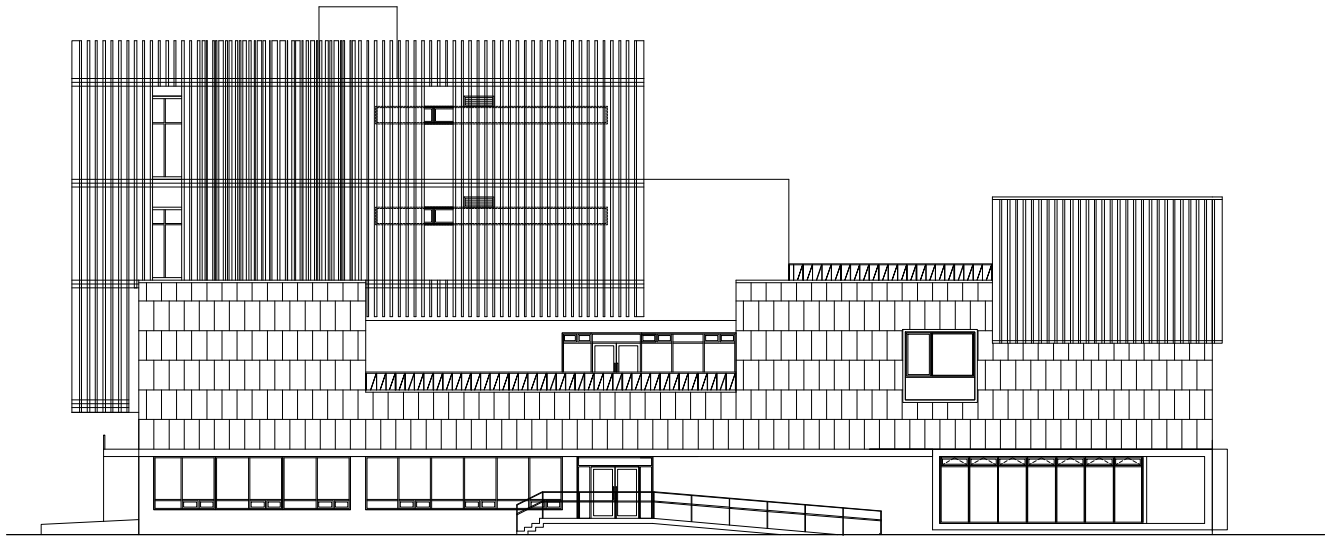

南向立面圖 unit:m | 0 | 2 | 5 | 10

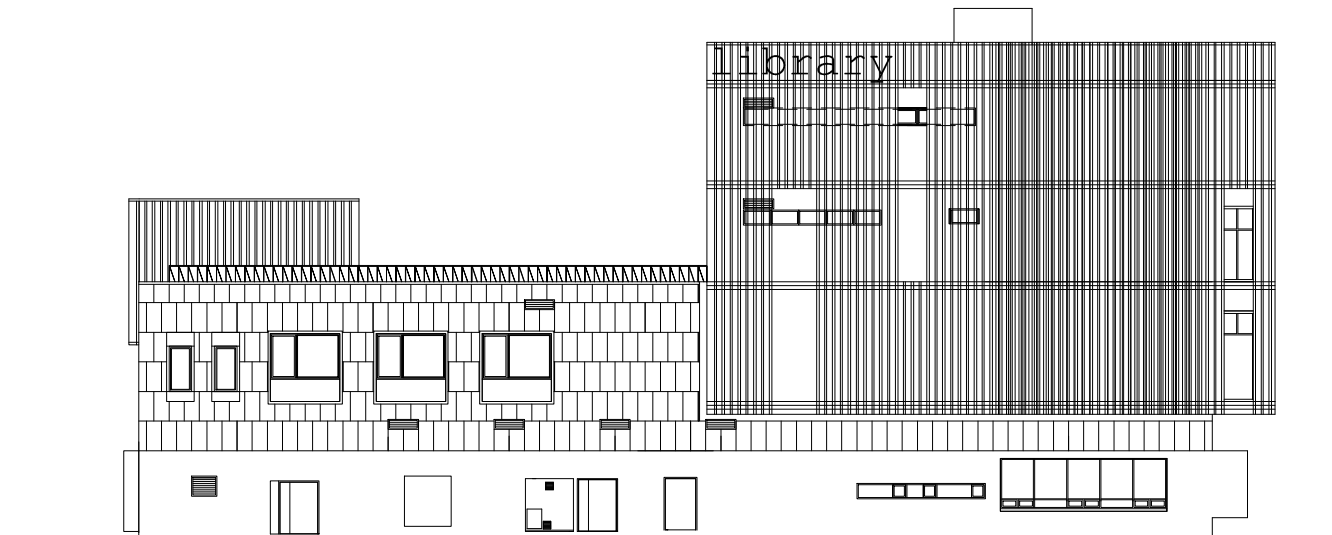

北向立面圖 unit:m | 0 | 2 | 5 | 10

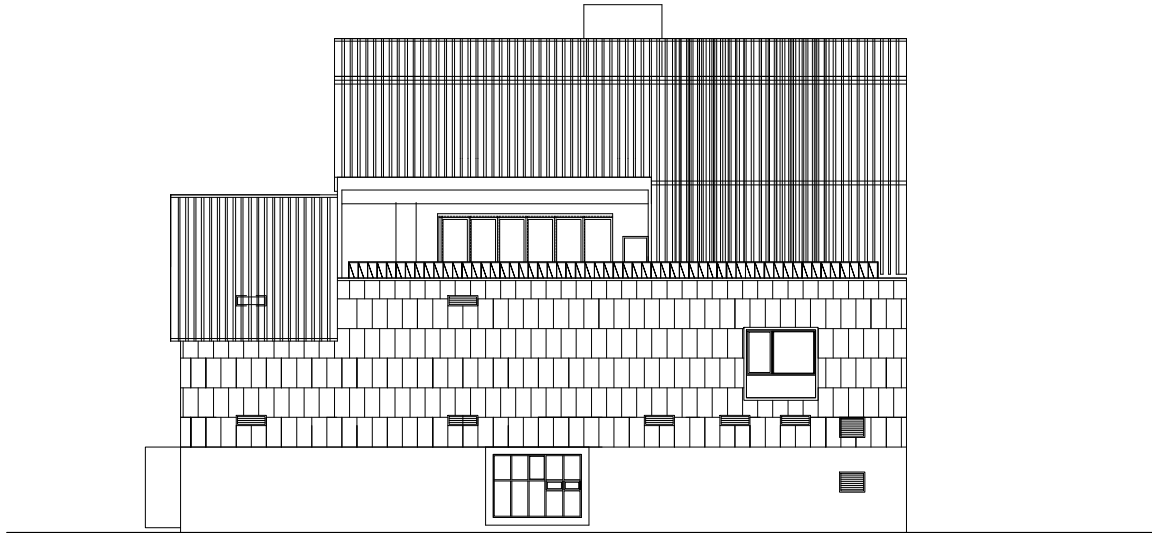

東向立面圖 unit: m | 0 | 2 | 5 | 10

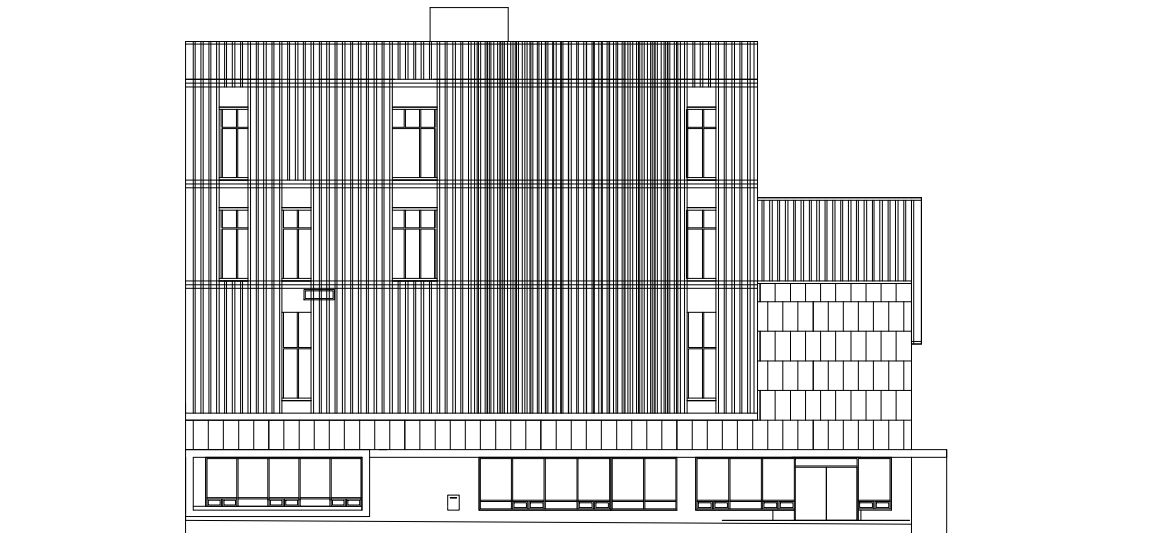

西向立面圖 unit: m | 0 | 2 | 5 | 10

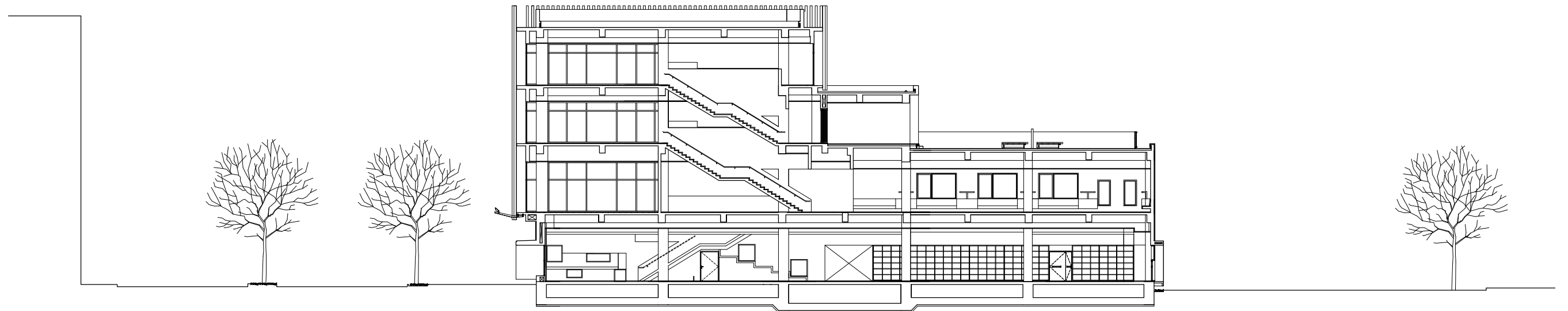

橫向剖面圖

unit: m | 0 | 2 | 5 | 10

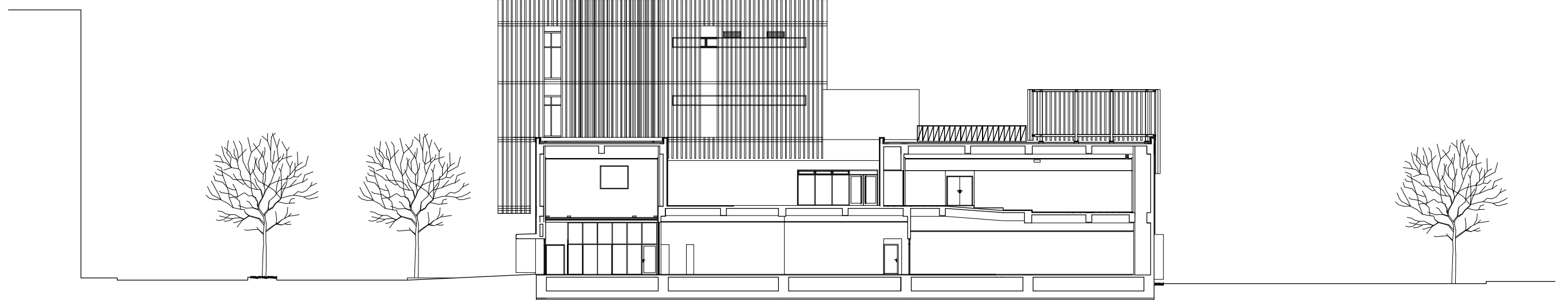
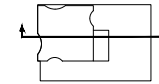

橫向剖面圖

unit: m | 0 | 2 | 5 | 10

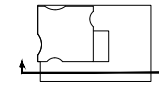

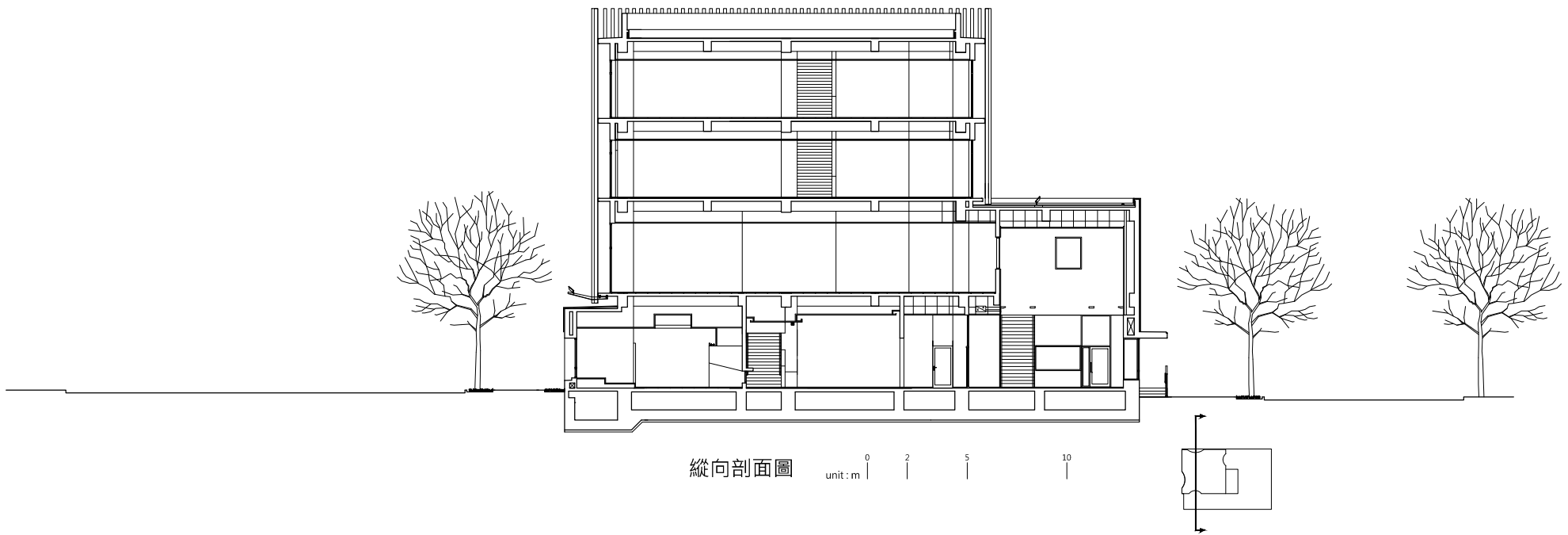
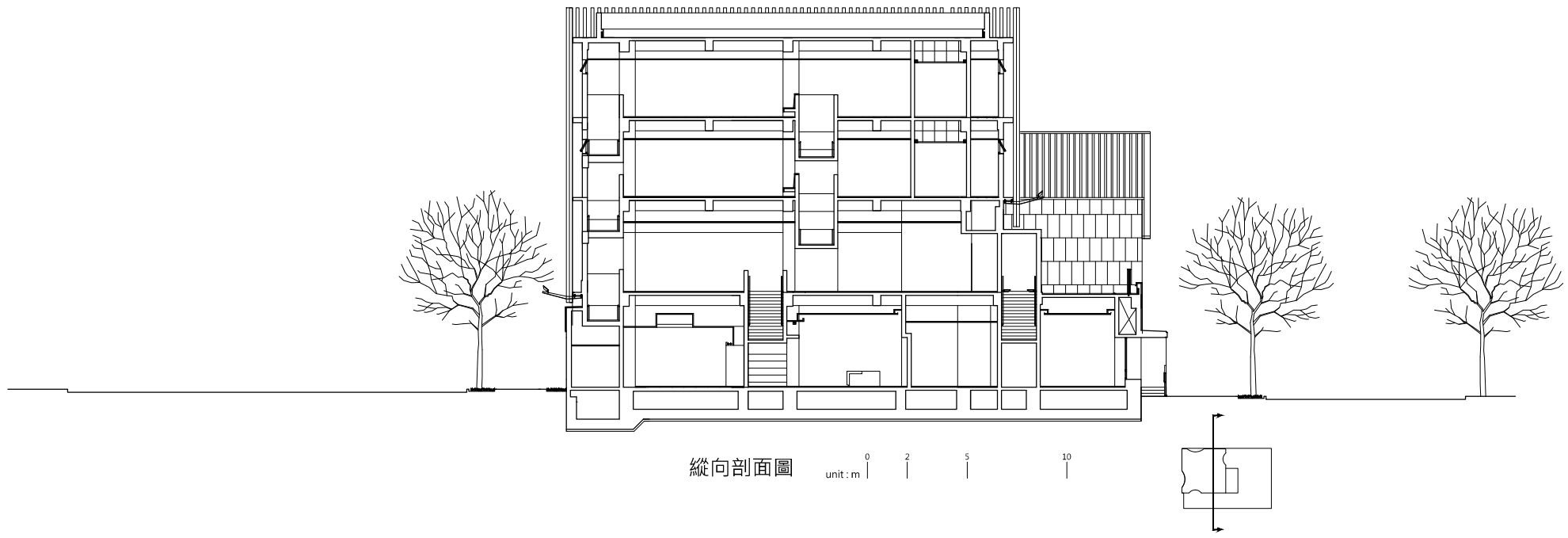

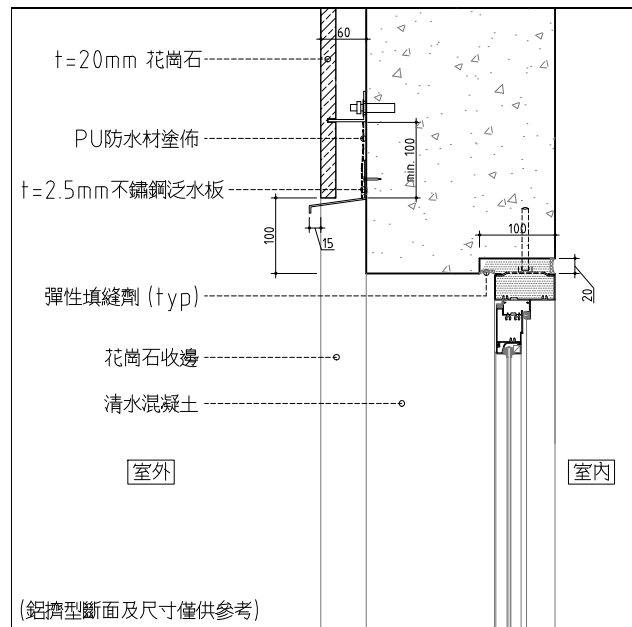

01 外掛石板+RC牆界面詳圖/W8窗詳圖(上部剖面)
SCALE: 1/5 UNIT: mm

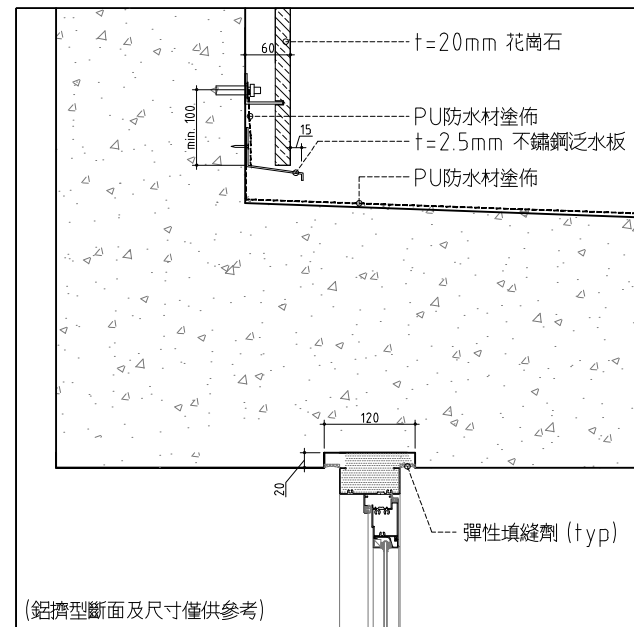

02 外掛石板+RC雨底界面詳圖/W7窗詳圖(上部剖面)
SCALE: 1/5 UNIT: mm

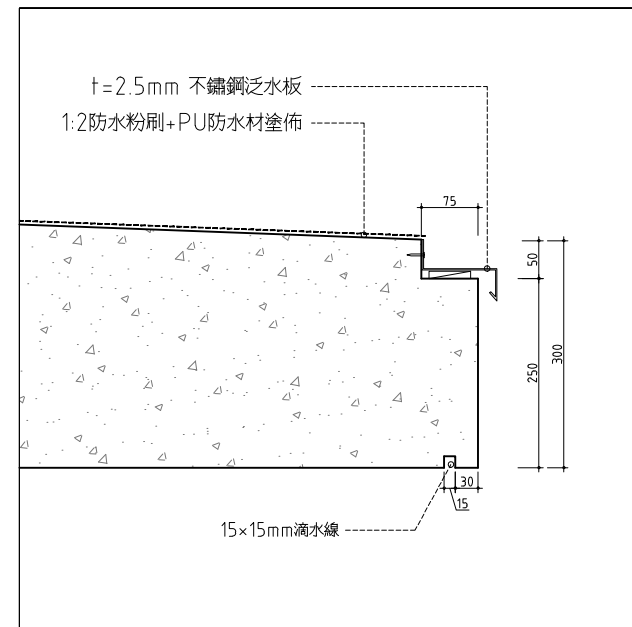

03 RC雨底邊緣詳圖
SCALE: 1/5 UNIT: mm

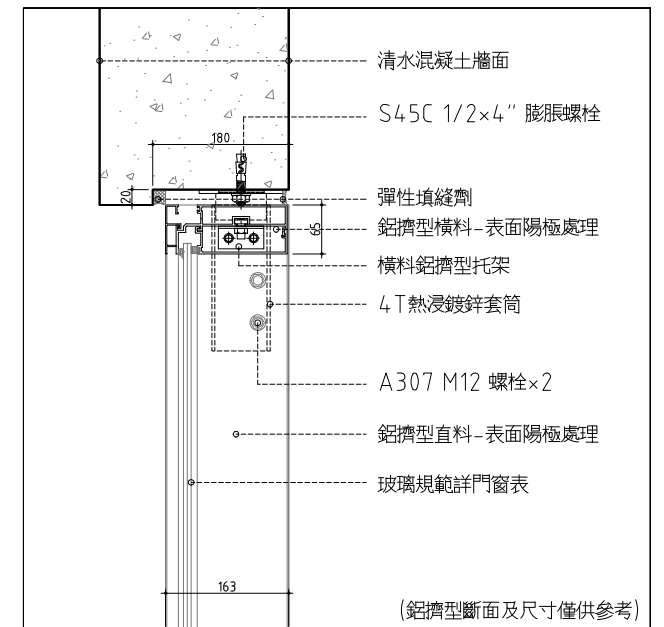

04 玻璃帷幕窗剖面詳圖(上部)
SCALE: 1/5 UNIT: mm

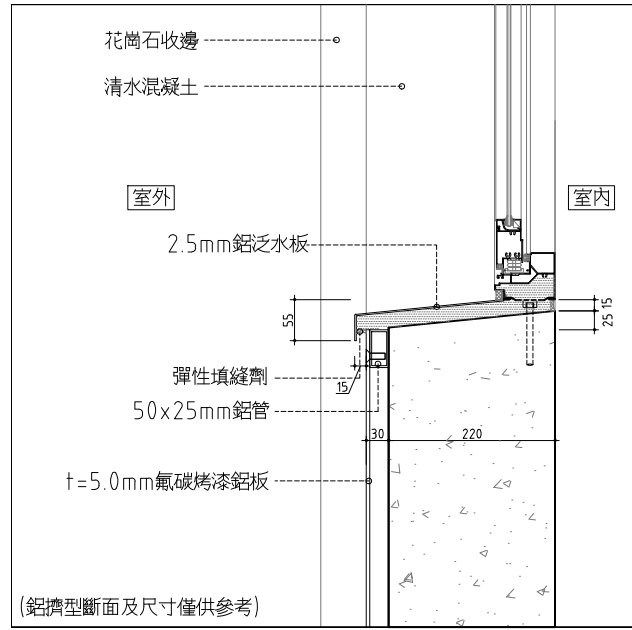

05 W8窗詳圖(下部剖面)
SCALE: 1/5 UNIT: mm

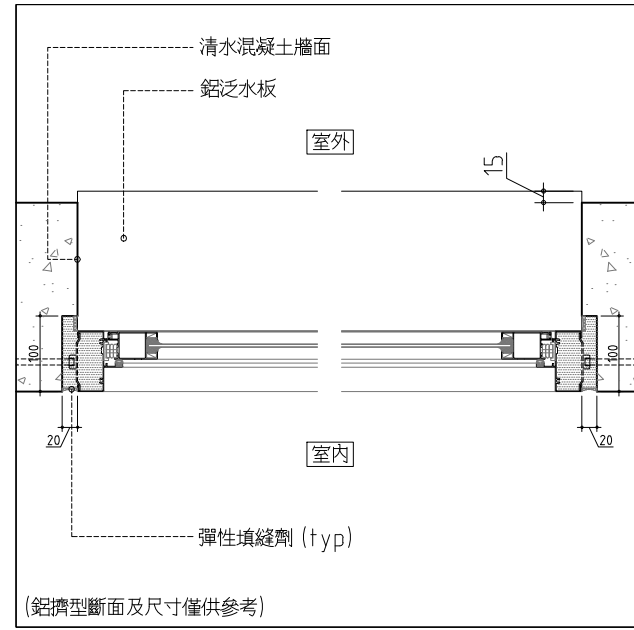

07 開口標準詳圖(側面平面)
SCALE: 1/5 UNIT: mm

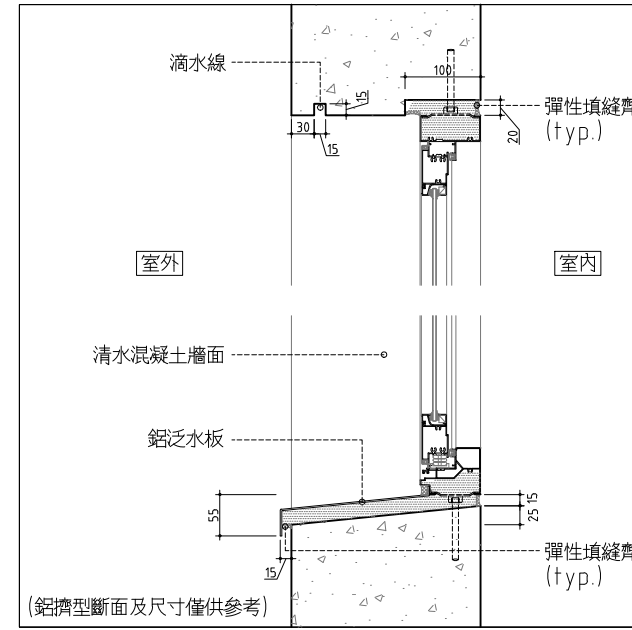

07 開口標準詳圖(剖面)
SCALE: 1/5 UNIT: mm

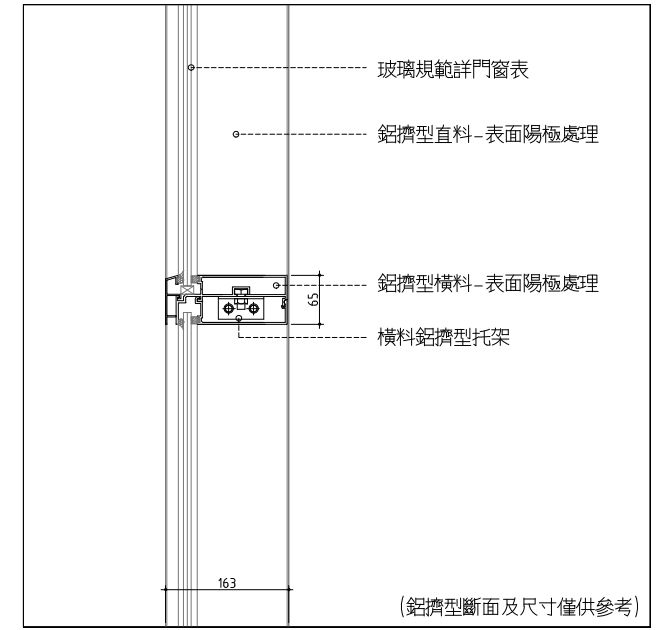

08 玻璃帷幕窗剖面詳圖(中段)開口標準詳圖(剖面)
SCALE: 1/5 UNIT: mm

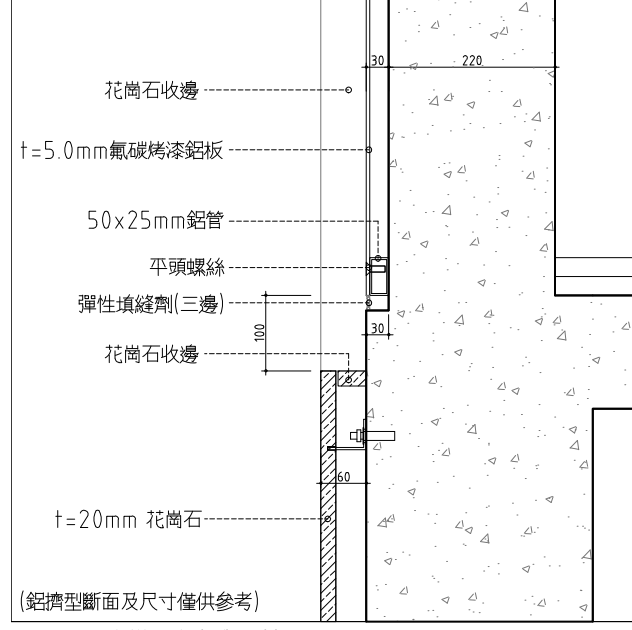

09 W8窗詳圖(鋁板與石材界面)
SCALE: 1/5 UNIT: mm

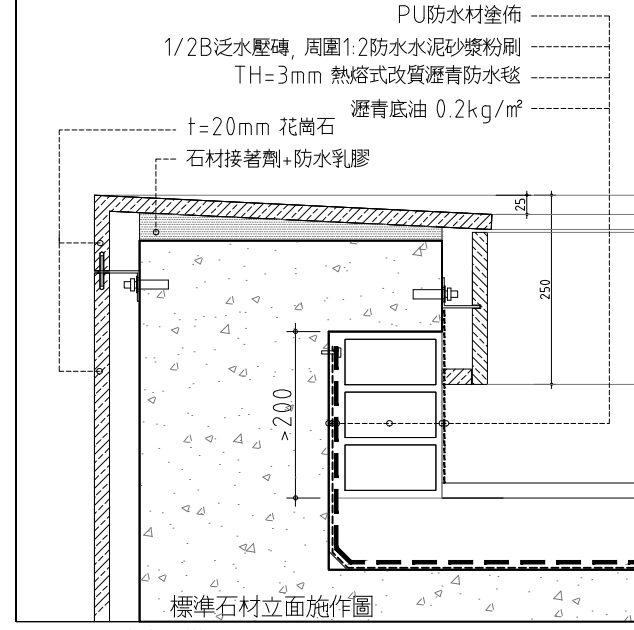

10 屋頂女兒牆詳圖
SCALE: 1/5 UNIT: mm

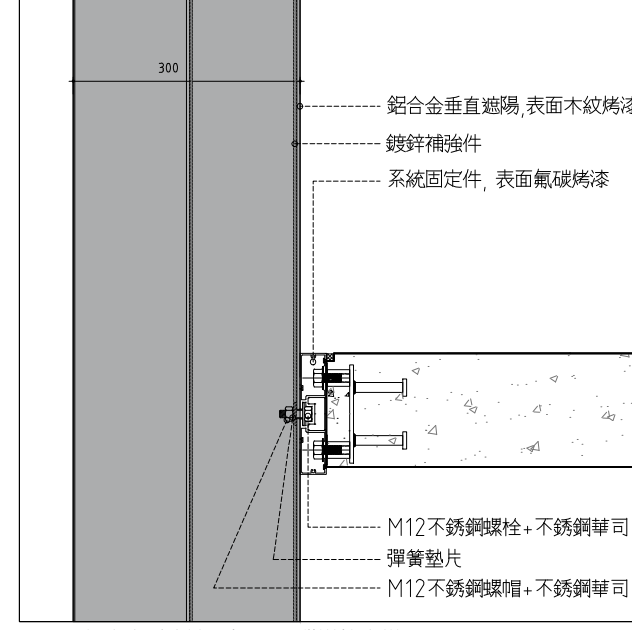

11 鋁合金垂直遮陽板及RC貓道接合詳圖
SCALE: 1/5 UNIT: mm

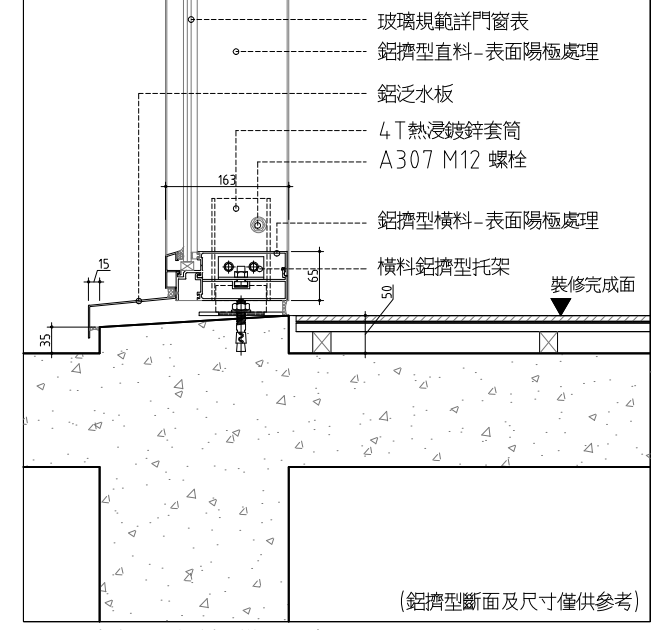

12 玻璃帷幕窗剖面詳圖(下部)
SCALE: 1/5 UNIT: mm

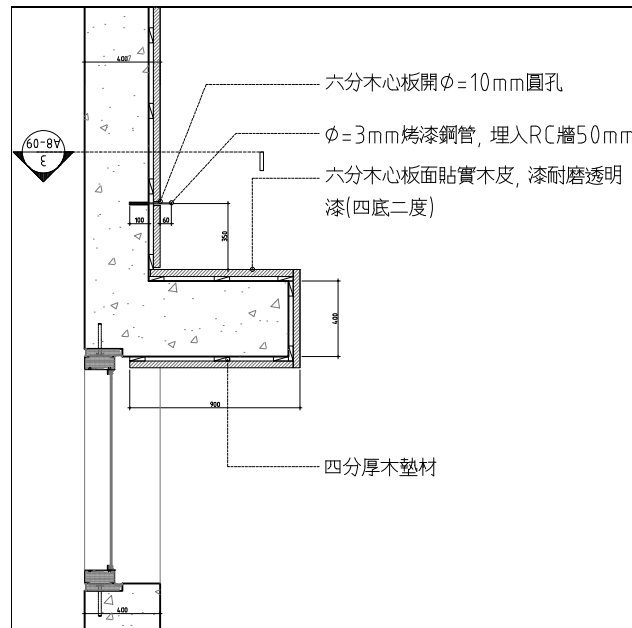

01 新書展示台 剖面詳圖
 SCALE: 1/10 UNIT: mm

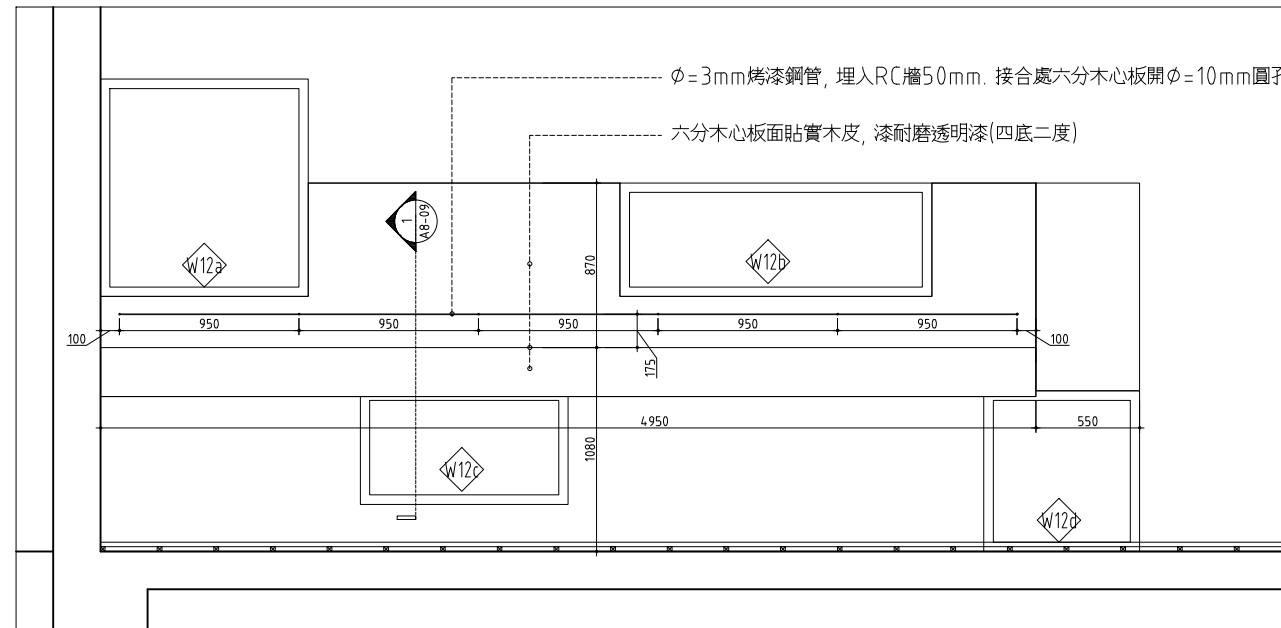

02 新書展示台 立面詳圖
 SCALE: 1/20 UNIT: mm

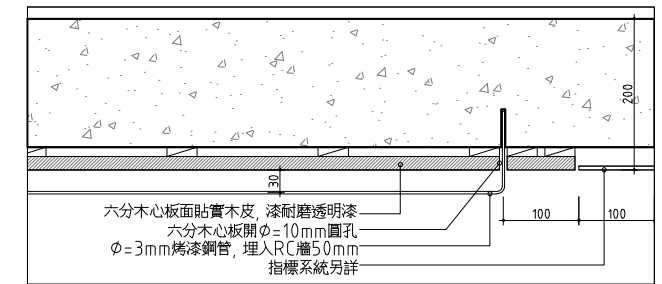

03 新書展示台 書架詳圖
 SCALE: 1/5 UNIT: mm

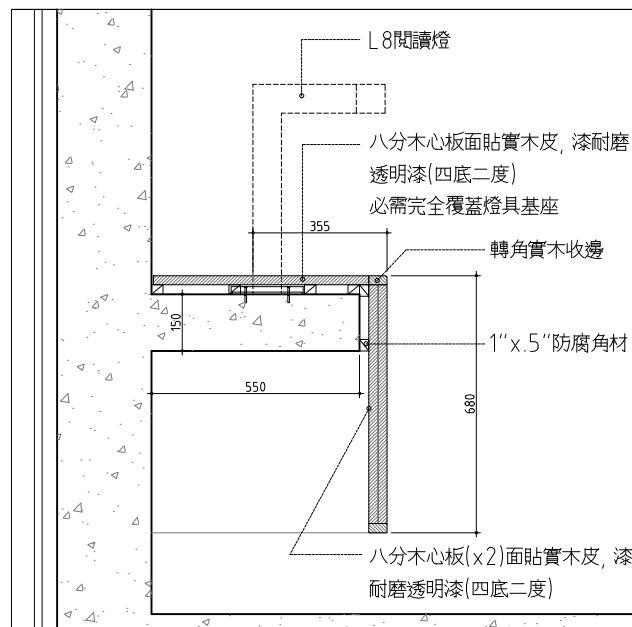

04 靠窗座椅 剖面詳圖(桌面區)
 SCALE: 1/10 UNIT: mm

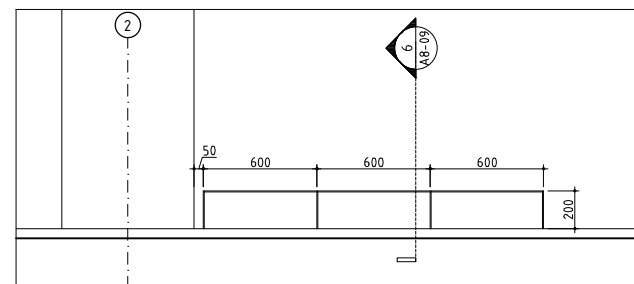

05 樓梯下金屬護欄 立面詳圖
 SCALE: 1/20 UNIT: mm

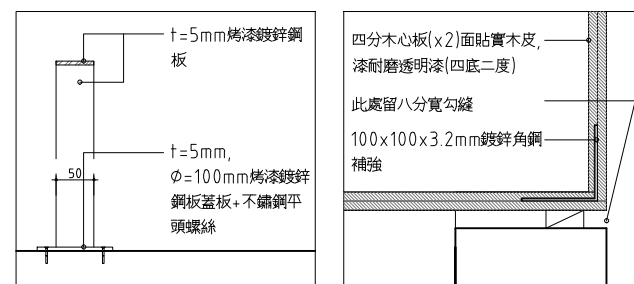

06 樓梯下金屬護欄 剖面詳圖
 SCALE: 1/5 UNIT: mm

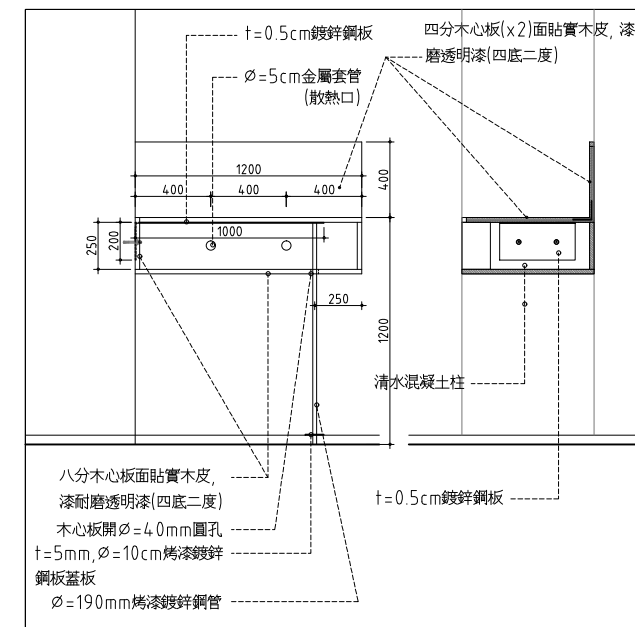

07 2/3/4F立式檢索台詳圖
 SCALE: 1/5 UNIT: mm

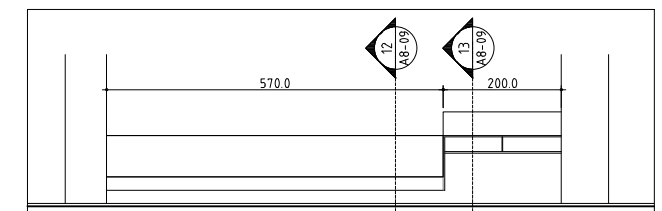

08 2F立式檢索架 詳圖
 SCALE: 1/20 UNIT: mm

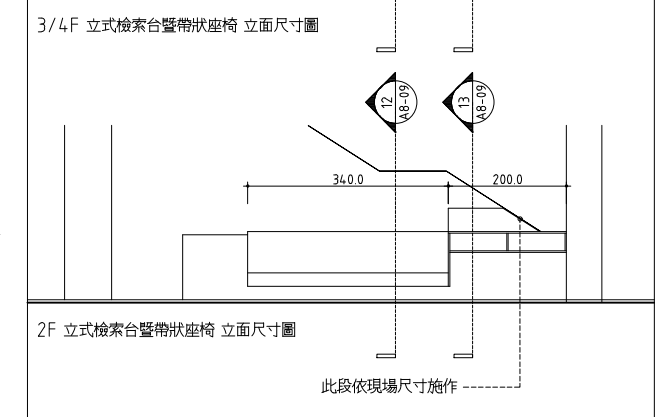

09 2/3/4F立式檢索台暨帶狀座椅 立面尺寸圖
 SCALE: UNIT: mm

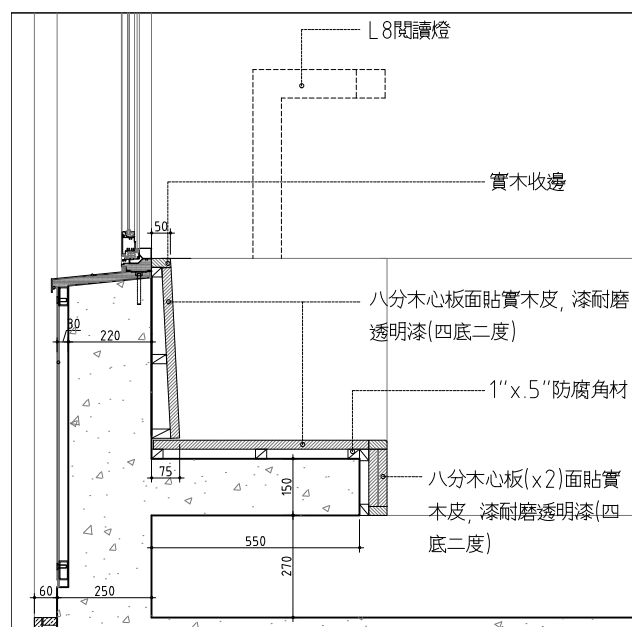

10 靠窗座椅 剖面詳圖(座位區)
 SCALE: 1/10 UNIT: mm

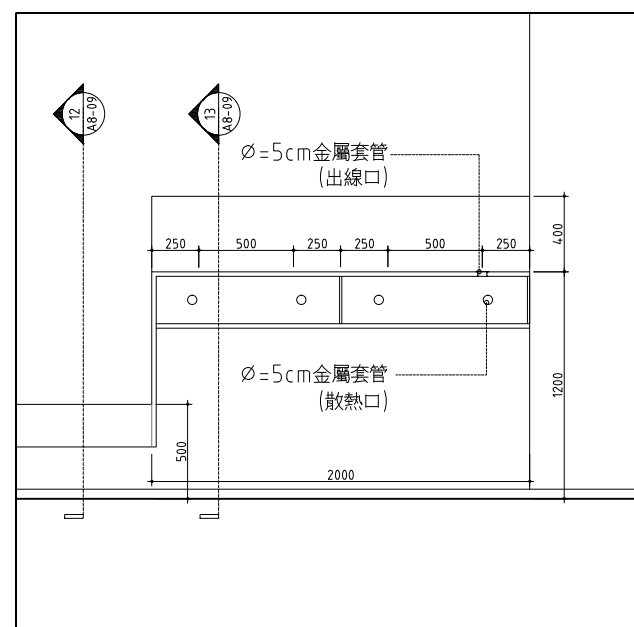

11 3/4F立式檢索台暨帶狀座椅 立面詳圖
 SCALE: 1/20 UNIT: mm

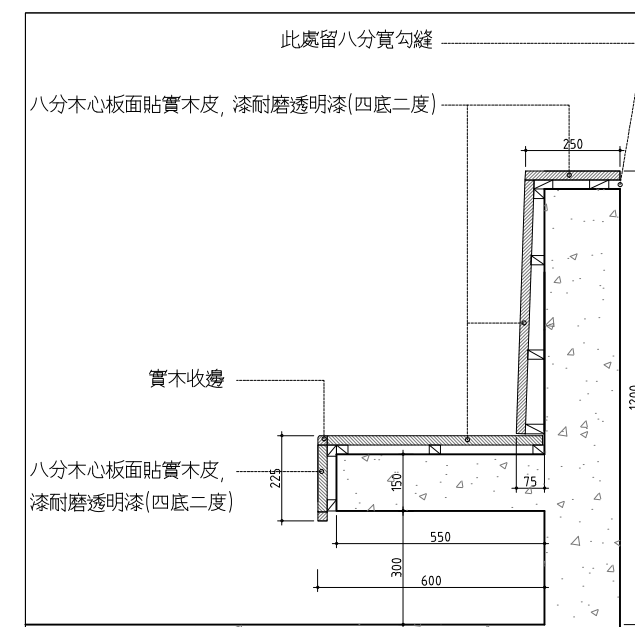

12 2/3/4F立式檢索台暨帶狀座椅 剖面詳圖(座位區)
 SCALE: 1/10 UNIT: mm

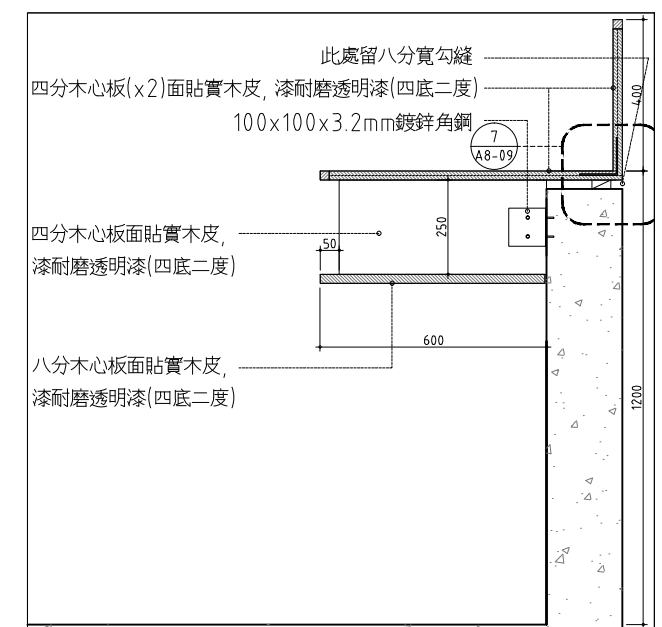

13 2/3/4F立式檢索台暨帶狀座椅 立面詳圖(檢索區)
 SCALE: 1/10 UNIT: mm

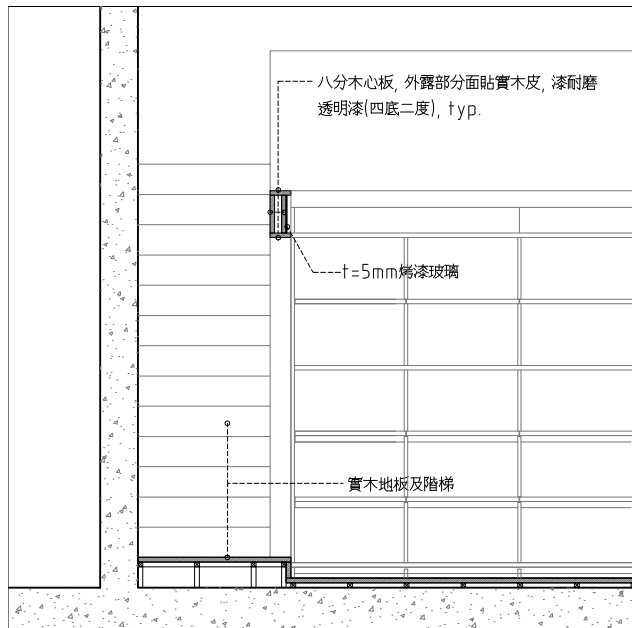

01 樹屋剖面詳圖
SCALE: 1/20 UNIT: mm

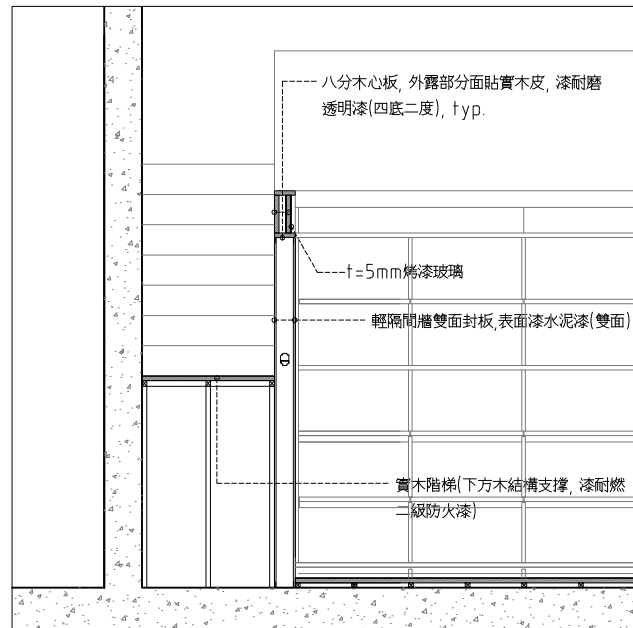

02 樹屋剖面詳圖
SCALE: 1/20 UNIT: mm

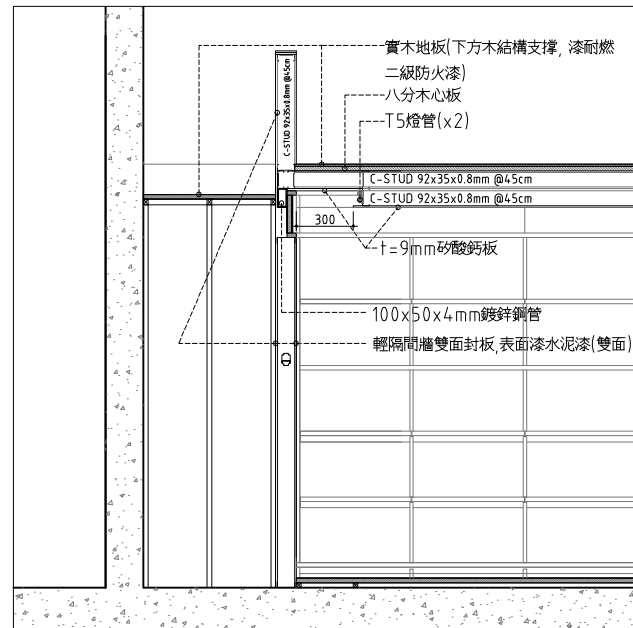

03 樹屋剖面詳圖
SCALE: 1/20 UNIT: mm

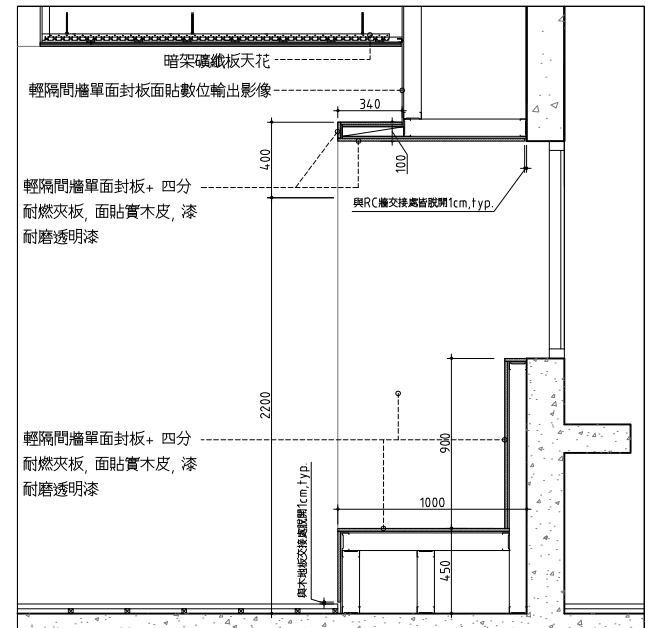

04 五層壁櫃 TYPE B 剖面詳圖
SCALE: 1/20 UNIT: mm

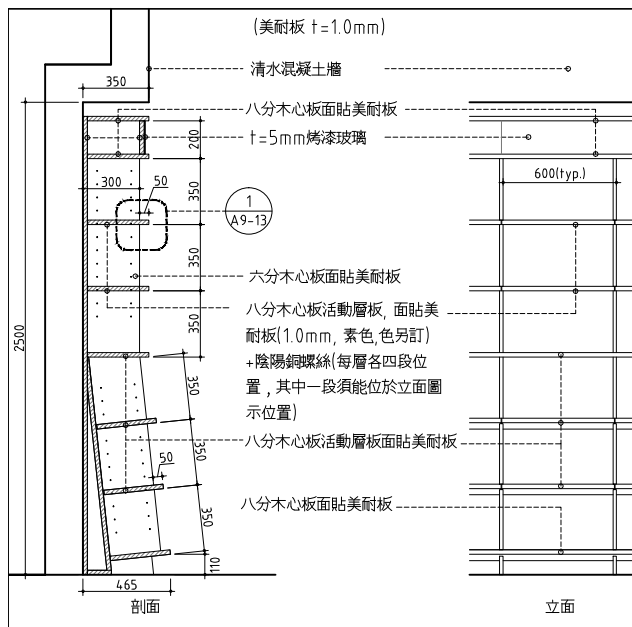

05 六層壁櫃詳圖
SCALE: 1/20 UNIT: mm

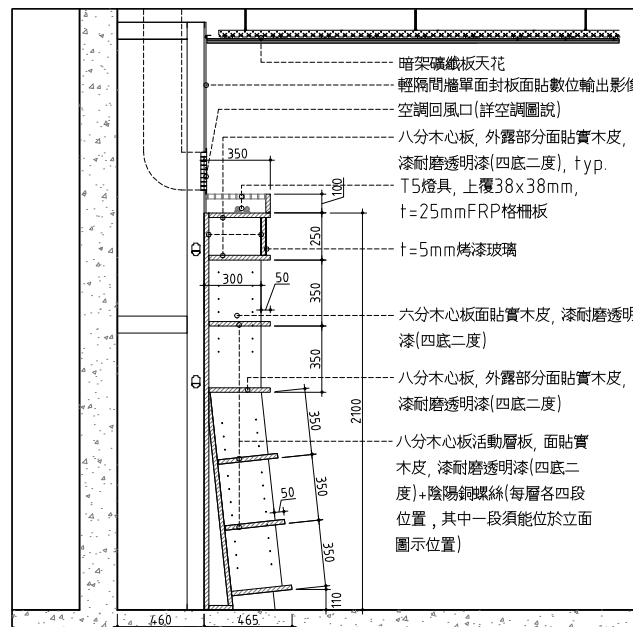

06 五層壁櫃 TYPE A 詳圖
SCALE: 1/20 UNIT: mm

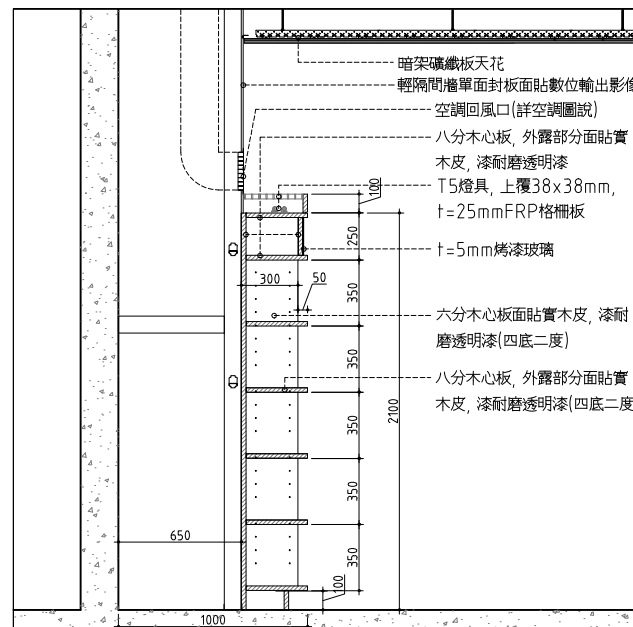

07 五層壁櫃 TYPE B 詳圖
SCALE: 1/20 UNIT: mm

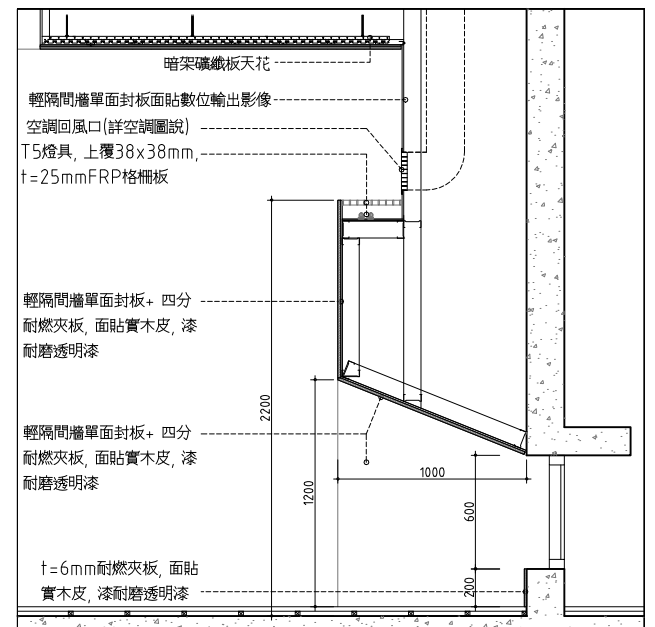

08 五層壁櫃 TYPE B 剖面詳圖
SCALE: 1/20 UNIT: mm

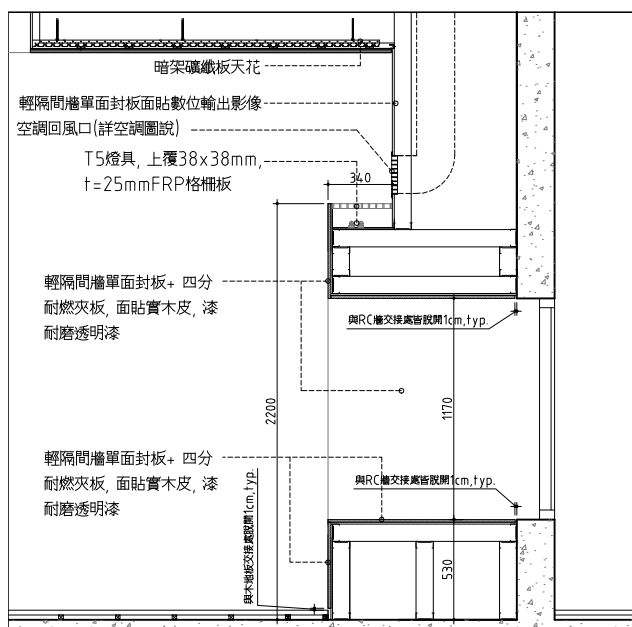

09 五層壁櫃 TYPE B 剖面詳圖
SCALE: 1/20 UNIT: mm

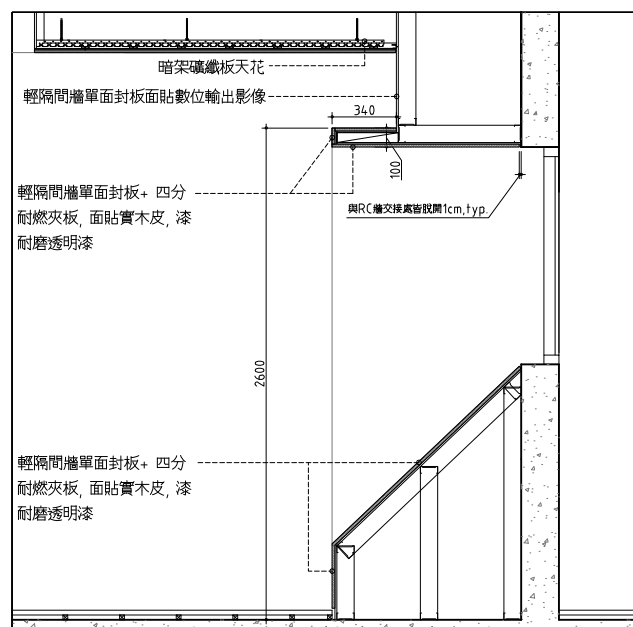

10 五層壁櫃 TYPE B 剖面詳圖
SCALE: 1/20 UNIT: mm

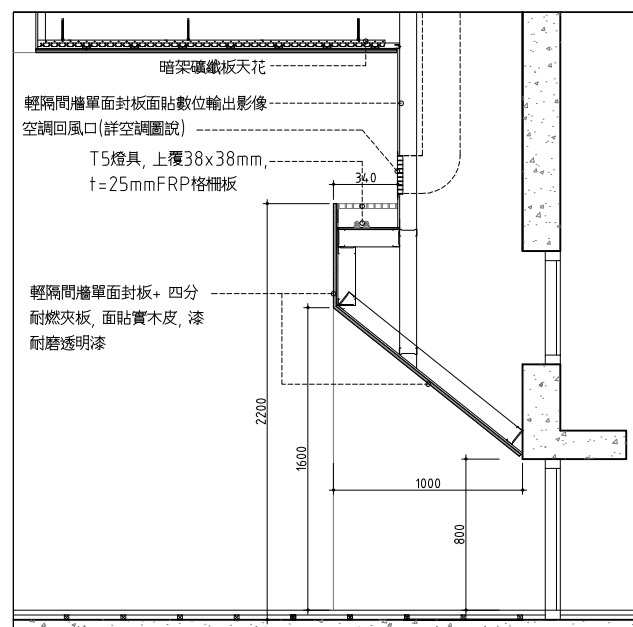

11 五層壁櫃 TYPE B 剖面詳圖
SCALE: 1/20 UNIT: mm

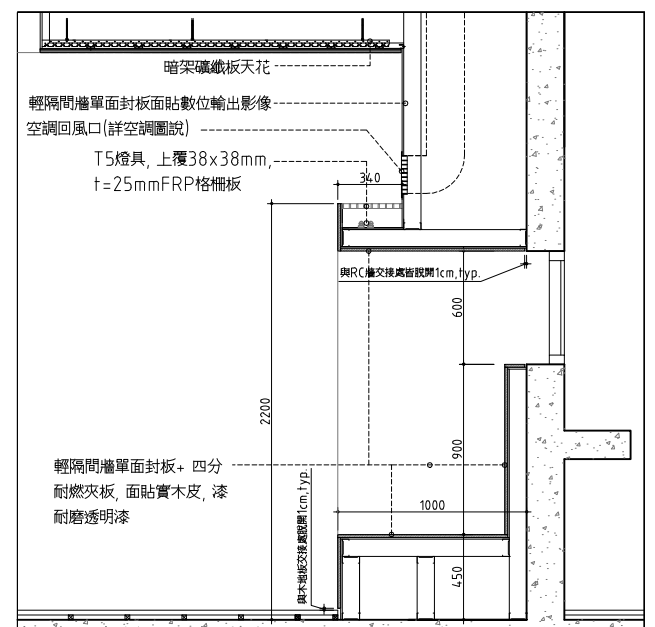

12 五層壁櫃 TYPE B 剖面詳圖
SCALE: 1/20 UNIT: mm