

EDUCATIONAL CENTRE / ZADAR

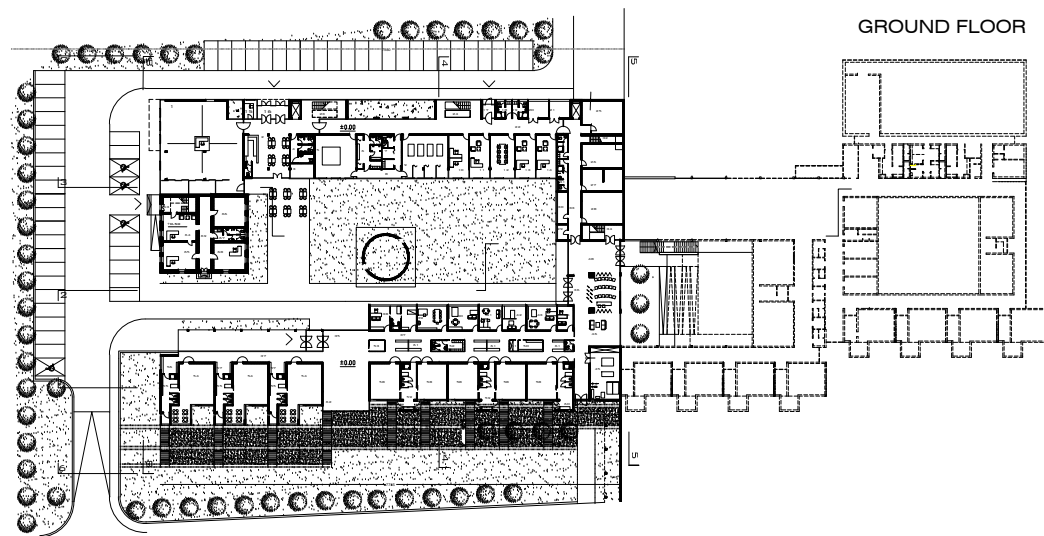

GROUND FLOOR

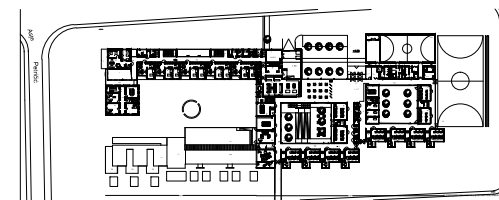

FIRST FLOOR

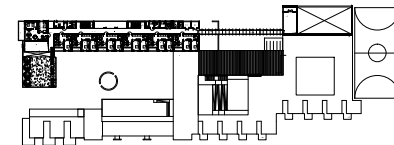

SECOND FLOOR

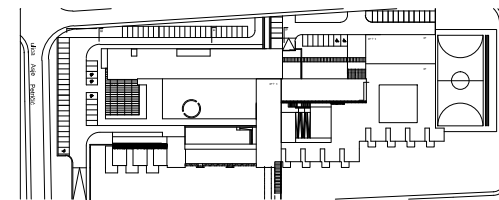

ROOF FLOOR

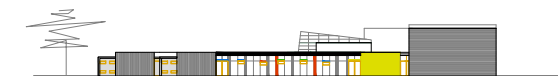

COMMERCIAL BUILDING - WAREHOUSE AND OFFICES / ZADAR

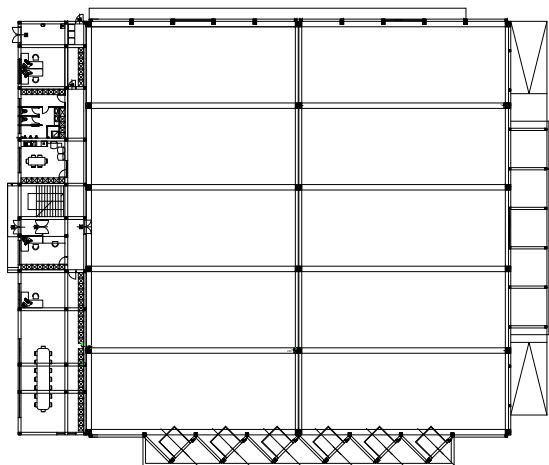

GROUND FLOOR

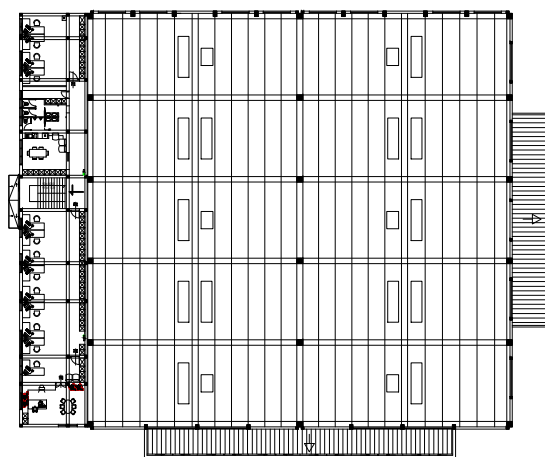

FIRST FLOOR

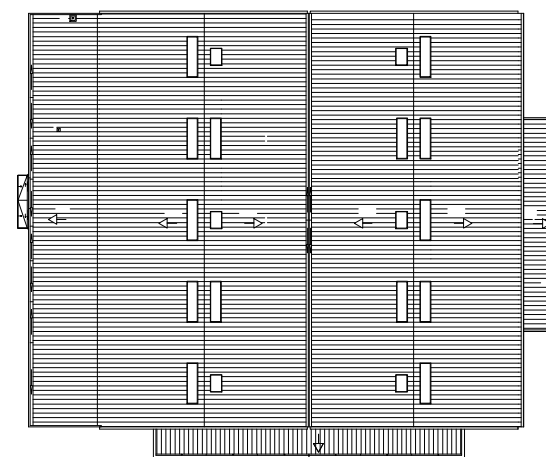

ROOF FLOOR

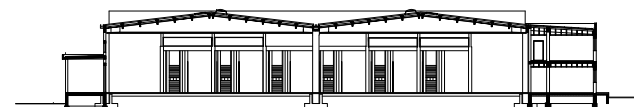
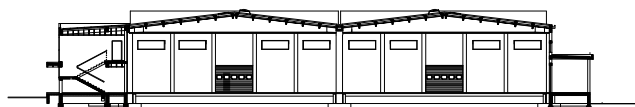
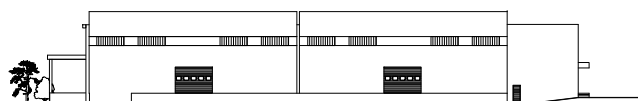
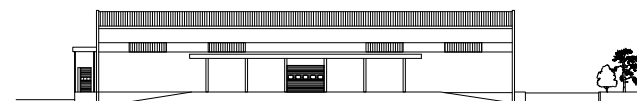
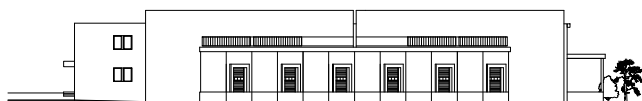

FIREHOUSE / VRSI

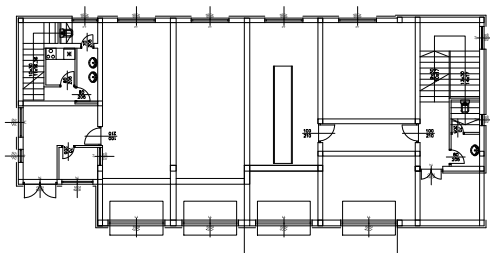

GROUND FLOOR

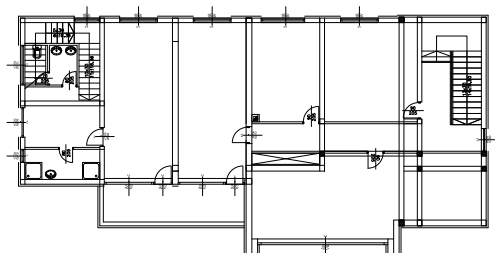

FIRST FLOOR

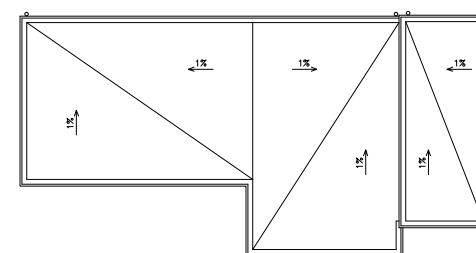

ROOF FLOOR

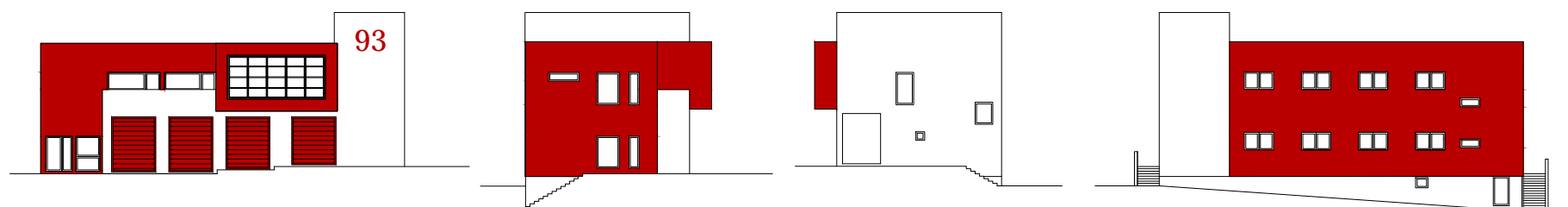
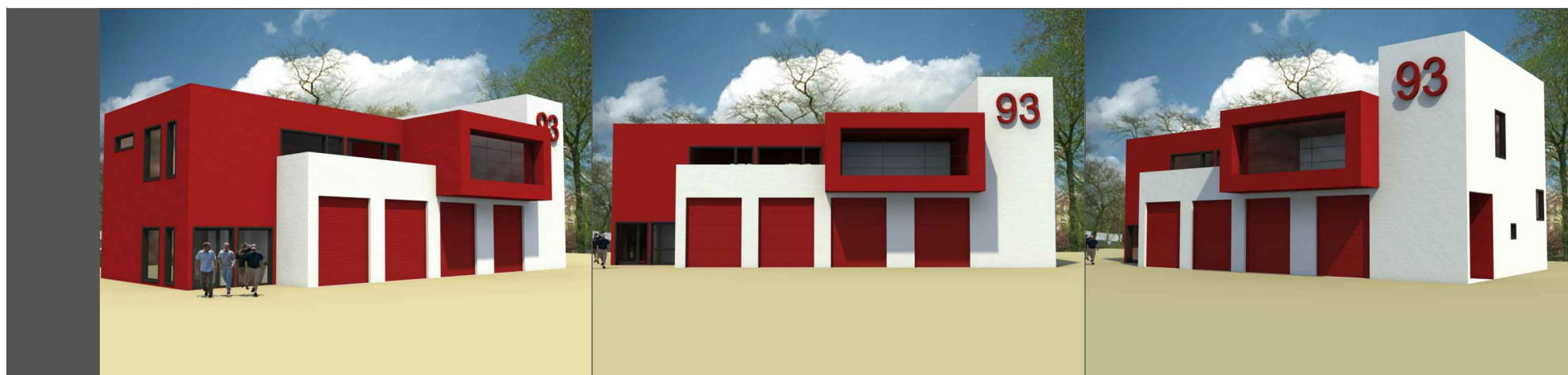

MORGUE AND CHAPEL / PREKO

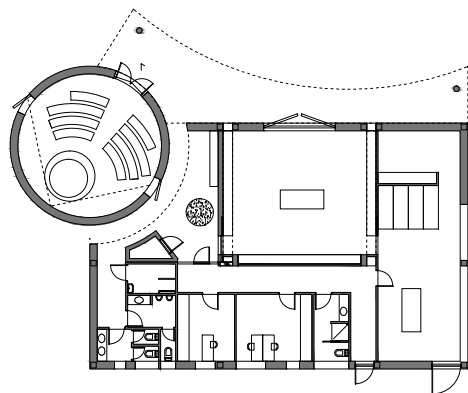

GROUND FLOOR

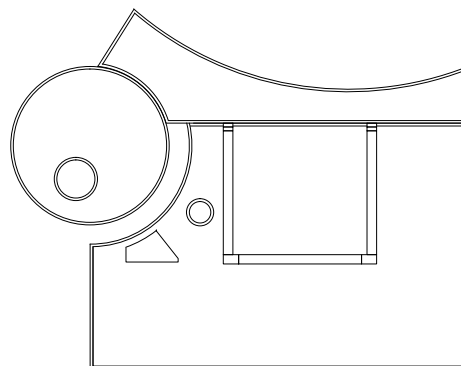

ROOF FLOOR

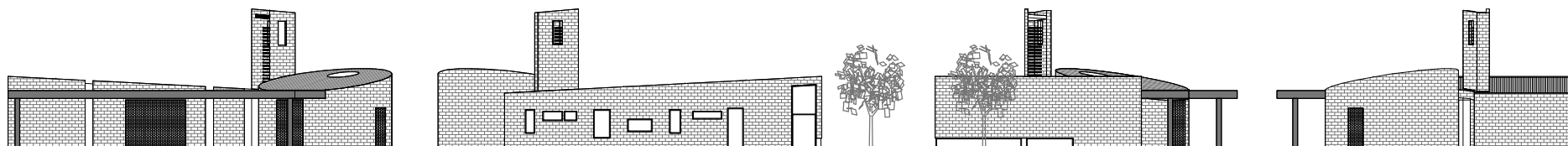

RESIDENTIAL - COMMERCIAL BUILDING / ZADAR

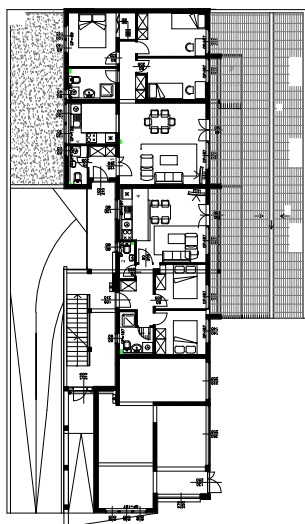

GROUND FLOOR

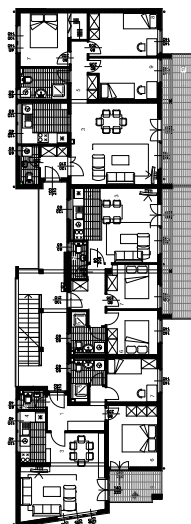

FIRST FLOOR

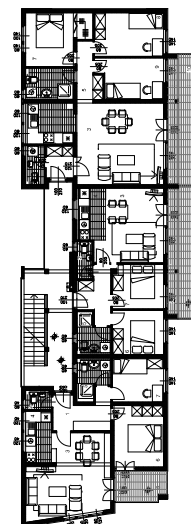

SECOND FLOOR

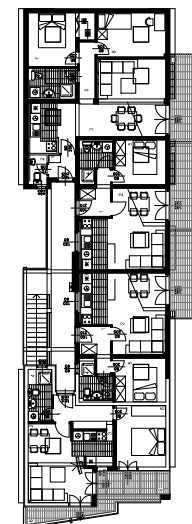

THIRD FLOOR

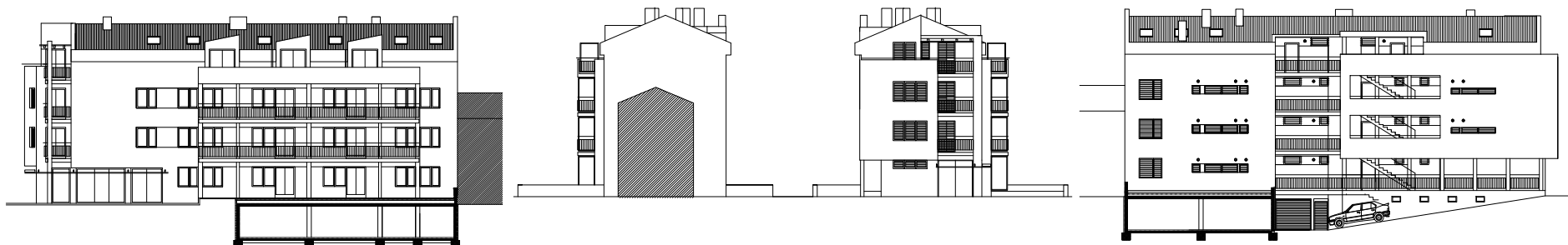

RESIDENTIAL BUILDING / PAG

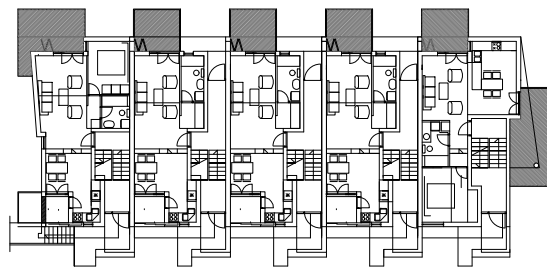

GROUND FLOOR



FIRST FLOOR

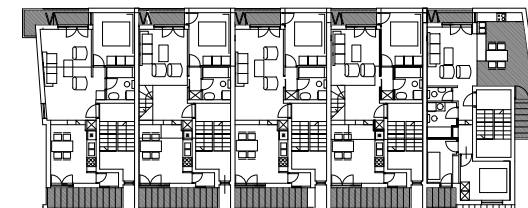

SECOND FLOOR

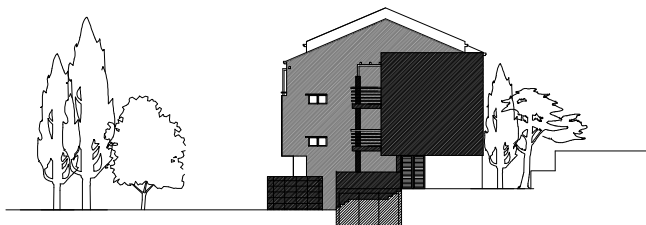
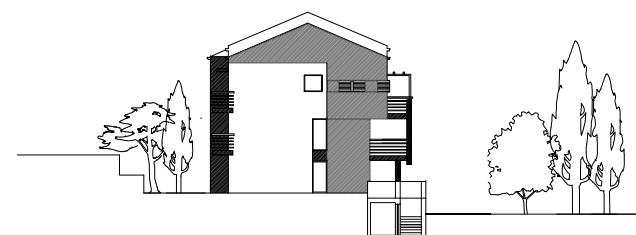

RESIDENTIAL BUILDING / VRSI

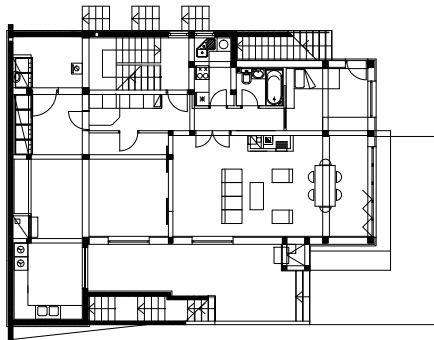

GROUND FLOOR

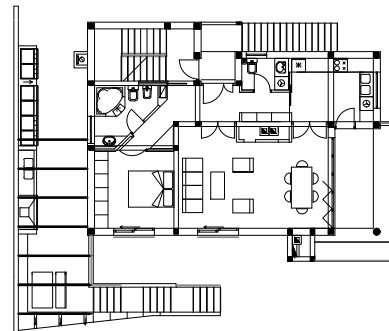

FIRST FLOOR

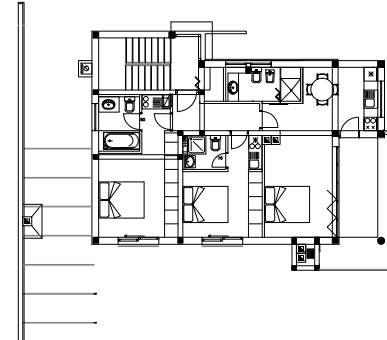

SECOND FLOOR

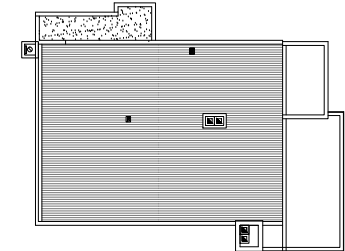

ROOF FLOOR



RESIDENTIAL BUILDING / PAG

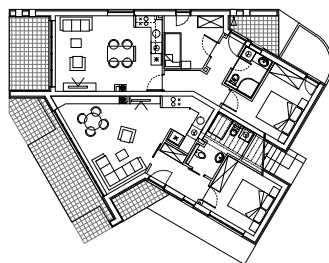

GROUND FLOOR

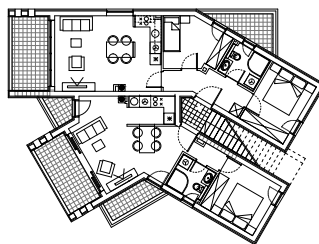

FIRST FLOOR

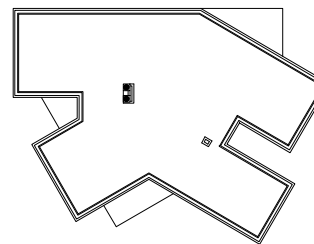

ROOF FLOOR

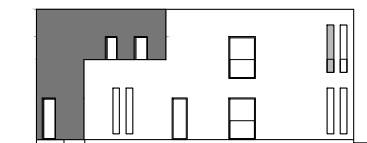
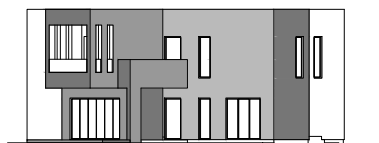



RESIDENTIAL BUILDING / ZADAR

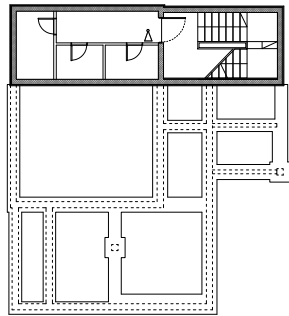

BASEMENT FLOOR

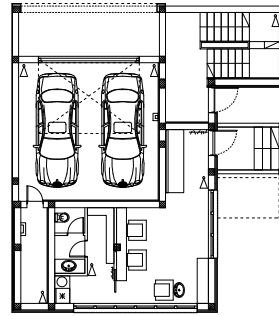

GROUND FLOOR

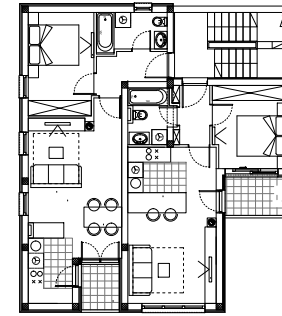

FIRST FLOOR

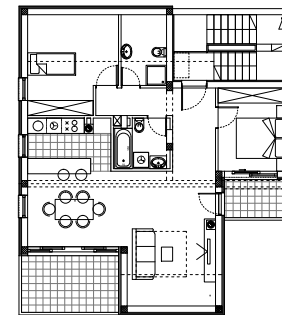

SECOND FLOOR

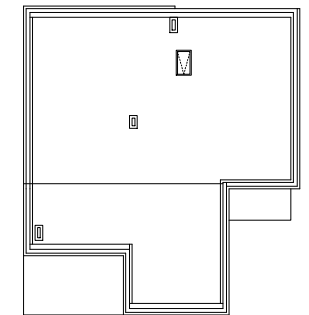

ROOF FLOOR

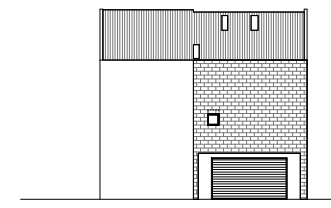
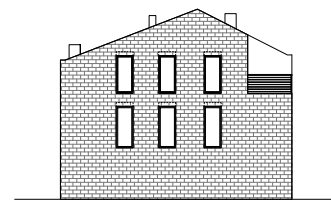
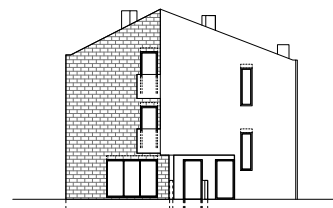

RESIDENTIAL BUILDING / BORIK - DIKLO / ZADAR

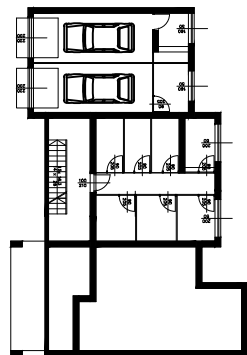

BASEMENT FLOOR

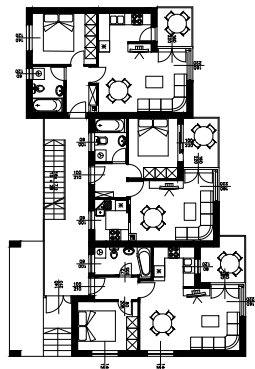

GROUND FLOOR

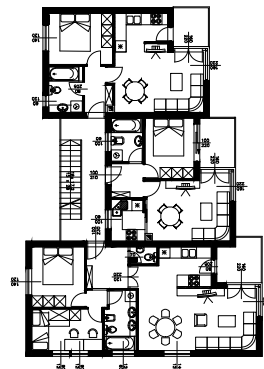

FIRST FLOOR

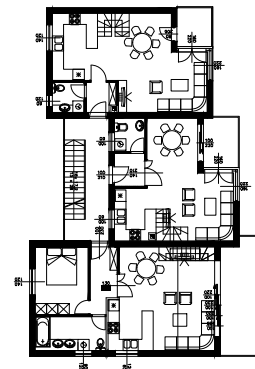

SECOND FLOOR

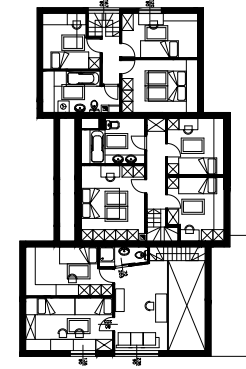

THIRD FLOOR

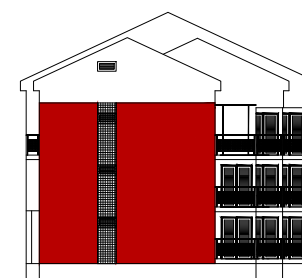
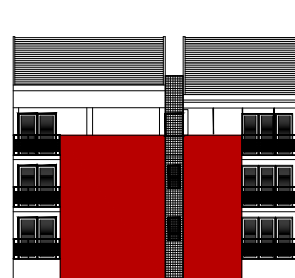
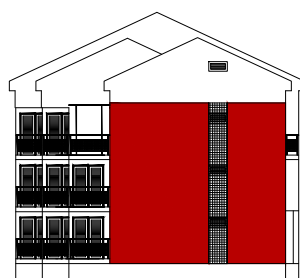
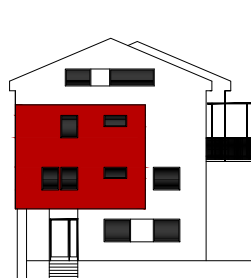

RESIDENTIAL - COMMERCIAL BUILDING / ZADAR

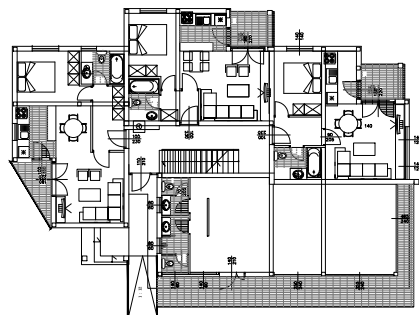

GROUND FLOOR

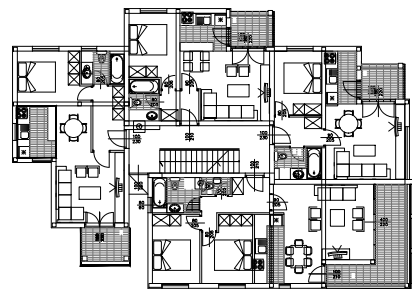

FIRST FLOOR

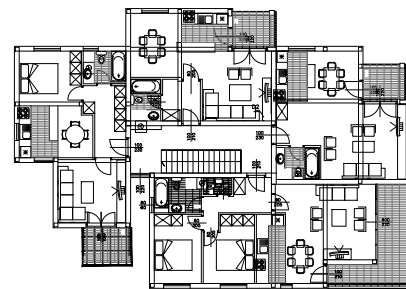

SECOND FLOOR

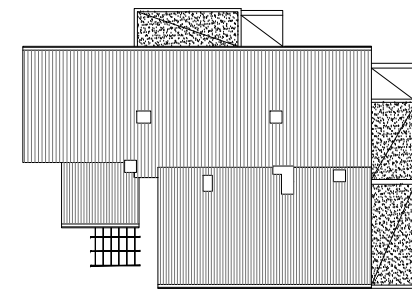

ROOF FLOOR



RESIDENTIAL BUILDING / KOŽINO / ZADAR

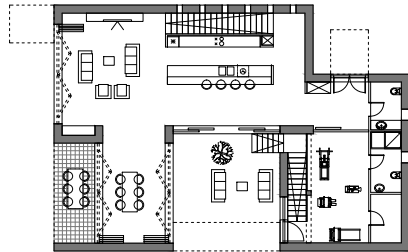

GROUND FLOOR

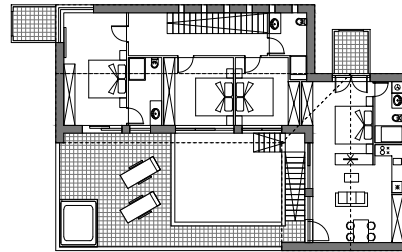

FIRST FLOOR

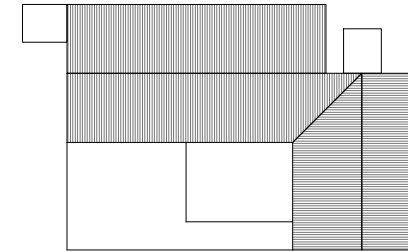

ROOF FLOOR

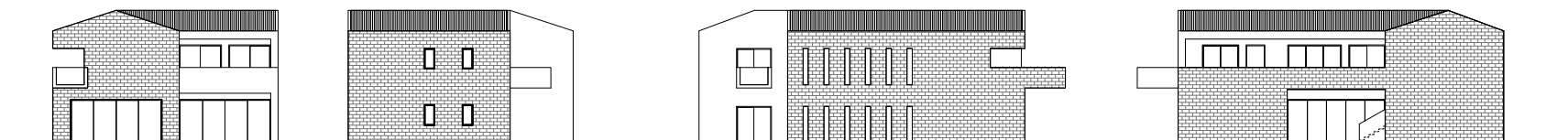

RESIDENTIAL BUILDING / ZAGREB

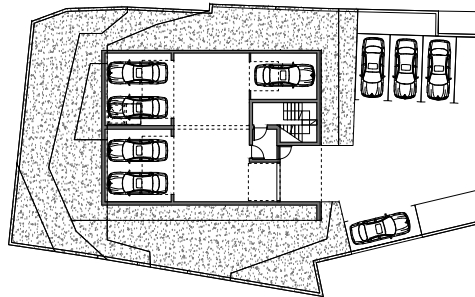

BASEMENT FLOOR

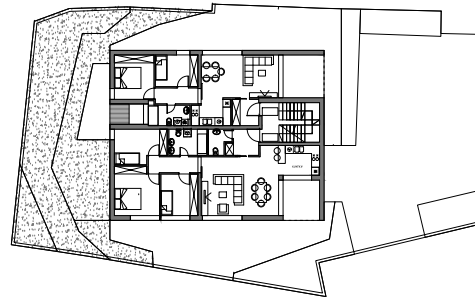

GROUND FLOOR

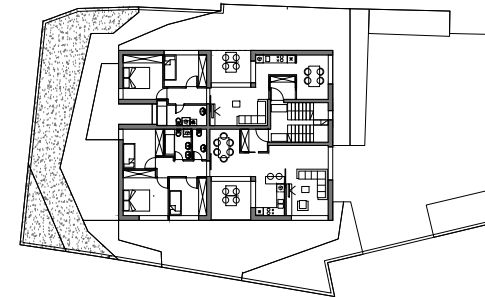

FIRST FLOOR

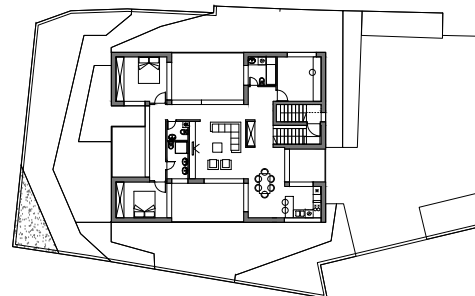

SECOND FLOOR

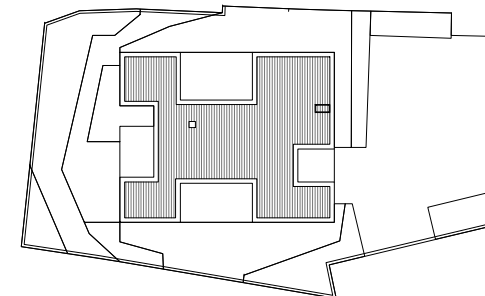

ROOF FLOOR

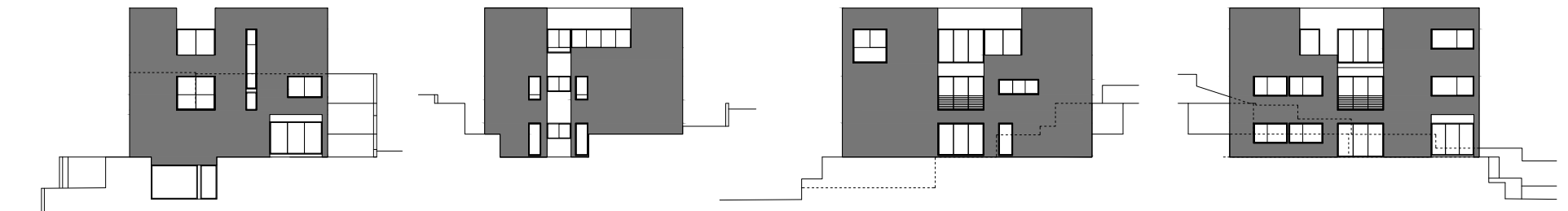

RESIDENTIAL BUILDING / TURANJ

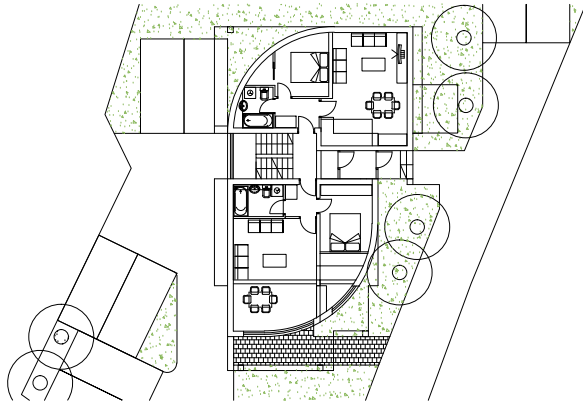

GROUND FLOOR

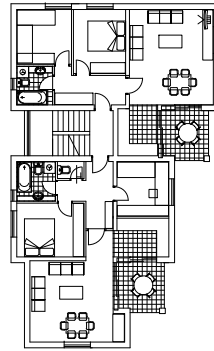

FIRST FLOOR

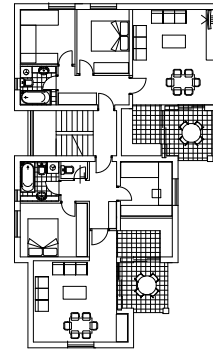

SECOND FLOOR

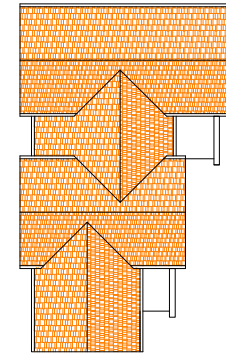

ROOF FLOOR

